

BRITISH RAIL
EASTERN REGION

SE

20

WEEKLY OPERATING NOTICE

CONTAINING

TEMPORARY SPEED RESTRICTIONS

TEMPORARY ENGINEERING WORKS

SIGNALLING AND
PERMANENT WAY ALTERATIONS

GENERAL INSTRUCTIONS AND NOTICES

SATURDAY 9 AUGUST

TO

FRIDAY 15 AUGUST 1986

INCLUSIVE

Trainmen must pay particular attention to works contained in this notice and keep a good look-out for handsignals which may be exhibited in accordance with the Rules and Regulations.

Work at places other than those mentioned may be in progress and Drivers must be on the look-out and be prepared to stop or run at reduced speed when, and where, handsignals may be exhibited.

SIGNALLING RECORD SOCIETY

www.s-r-s.org.uk

This PDF Copy is one of a number scanned by John Lacy using material from his own collection. It is provided free of charge by John in order to assist your research into UK signalling.

You may also like to provide copies of Signalling Notices and Weekly (and periodical) Operating Notices as scans or as originals. The SRS is always willing to accept donations of any signalling or signalling related material for inclusion in the Society's Archive. Please contact the [Webmaster](#) in the first instance.

For a list of PDFs currently available visit the list of [Weekly](#) Notices or [Signalling](#) Notices page.

If you have benefited from this PDF copy, why not [join](#) the Signalling Record Society and receive support for your researches and access to the Society's Archives

Members receive "The Signalling Record" six times annually plus a newsletter and have the opportunity to purchase SRS [books](#) and other [publications](#) at a discount. They also have access to back issues of The Newsletter and The Signalling Record which are only available to members. These contain a wealth of information accumulated since 1970, much of which is not readily available anywhere else.

In addition, Members have the opportunity to join signalling related visits to locations on the UK national and London Underground systems; and to other UK Railways.

To join the Signalling Record Society visit

www.s-r-s.org.uk/membform.html



WARNING



*
* ENERGISATION OF DOCKLANDS LIGHT RAILWAY BETWEEN BOW AND *
* STRATFORD STATION (ADJACENT TO THE B.R. UP ELECTRIC LINE) *
* *
* From 00 01 hours on Monday 18 August 1986, the conductor rails *
* between Bow Church, south of Bow Junction and Stratford Station *
* will be energised at 750 volts D.C. and must thereafter be regarded *
* as 'ALIVE' at all times. *
* (22) *
*

SECTION A

TEMPORARY SPEED RESTRICTIONS

(Until further notice unless otherwise specified)

Warning Boards and Indicators provided unless otherwise shown.

† Indicates that the Warning Boards and Indicators will be moved as the work progresses. Where two speeds are shown for a restriction e.g. $\frac{20}{40}$ the Rule

Book, Section U, Clause 1.2 applies.

Location	Lines affected	Mileage at or between		Restriction	Remarks
		M. Ch.	M. Ch.		

LIVERPOOL STREET TO NORWICH

Warning board at 0m. 63chs. (on the Down Main line) applies only to trains proceeding over the Down Electric line towards Stratford.

1	Bethnal Green Station Jn and Bow Jn	Down Electric	-	1 25	1 27	20	Bridgework (No. 28). (86/14)
2	Bow Jn and Bethnal Green Station Jn	-	Up Electric	1 27	1 25	30	Bridgework (No. 28). (86/14)
3	Bow Jn and Stratford	Down Electric	Up Electric	3 56	3 62	20	Trackwork. (86/19)

Warning board at 4m. 23chs. (on the Up Main line) applies only to trains proceeding over the Up Electric line towards Bow Jn.

4	Goodmayes Station and Ilford Car Sheds	-	Up Main	8 55	8 40	40	Condition of track. (85/65)
5	Harold Wood and Brentwood	Down Main	-	15 02	15 42	$\frac{20}{40}$	Condition of track. (85/61)
6	Brentwood and Shenfield	Down Main	-	18 30 †	19 44	30	Trackwork. (86/14)
7	Brentwood and Ingatestone	Down Main	-	19 65	20 33	50	Condition of track. (86/14)
8	Shenfield and Brentwood	-	Up Main	18 37	18 22	40	Condition of track. (86/12)

SECTION A - TEMPORARY SPEED RESTRICTIONS - continued

Location	Lines affected		Mileage		Restr- iction m.p.h.	Remarks
			at or between M. Ch. M. Ch.			
<u>LIVERPOOL STREET TO NORWICH - continued</u>						
9 Shenfield and Brentwood	-	Up Main	19 44 †	18 37	20	Trackwork. (86/14)
10 Shenfield Jn and Brentwood	-	Up Main	20 22	20 08	50	Condition of track. (86/14)
11 Chelmsford and New Hall G.F.	Down	-	30 50	30 65	50	Condition of track. (86/12)
12 New Hall G.F. and Hatfield Peverel	Down	-	34 40 †	34 60	40	Trackwork. (86/18)
13 New Hall G.F. and Witham	Down	-	34 60	38 27	60	Condition of track. (86/17)
14 Hatfield Peverel and Witham	Down	-	38 27	38 42	20	Condition of track. (86/17)
15 Witham and Church Street LC	Down	-	38 55	39 16	30	Earthwork. <u>From 07 00</u> <u>until 16 00</u> <u>Sunday 10</u> <u>August.</u>
16 Church Street LC and Witham	-	Up	39 16 †	38 55	20	Earthwork. (86/19)
17 Kelvedon	-	Up	42 25	42 10	<u>50</u> 80	Condition of track. (86/7)
18 Marks Tey Yard and Long Green LC	-	Up	46 57	46 46	20	Earthwork. (86/16) <u>Until 10 00</u> <u>Tuesday 12</u> <u>August.</u>
19 Colchester Jn and Ardleigh LC	Down	-	53 05 †	54 08	20	Trackwork. (86/16) <u>Until 10 00</u> <u>Wednesday 13</u> <u>August.</u>

SECTION A - TEMPORARY SPEED RESTRICTIONS - continued

Location	Lines affected		Mileage		Restr- iction m.p.h.	Remarks	
			at M.	or between Ch. M. Ch.			
<u>LIVERPOOL STREET TO NORWICH - continued</u>							
20	Newton Flotman LC and Moulton LC	-	Up	104 61	104 45	40	Trackwork. From 00 30 <u>Sunday 10</u> <u>August.</u> (86/20)
<u>SHENFIELD JN TO SOUTHEND VICTORIA</u>							
21	Billericay and Wickford Station	Down	-	26 10	26 44	40	Condition of track. (86/14)
22	Wick Lane LC and Rayleigh	Down	-	31 35	31 75	40	Condition of embankment. (84/41)
<u>WICKFORD JN TO SOUTHMINSTER</u>							
23	Althorne LC and Burnham-on- Crouch	Single		41 10 †	42 10	20	Trackwork. (85/45)
<u>COLCHESTER TO CLACTON</u>							
24	Colchester Road LC and Frating LC	Down	-	59 14	59 58	20	Trackwork. (86/17)
25	Frating LC and Colchester Road LC	-	Up	59 58	59 14	30	Trackwork. From 23 00 <u>Saturday 9</u> <u>until 16 00</u> <u>Sunday 10</u> <u>August.</u>
<u>MANNINGTREE SOUTH JN. TO HARWICH</u>							
26	Bradfield LC and Wrabness	Down	-	63 37	63 39	40	Earthwork. (85/55)
27	Parkeston Goods Jn and Wrabness	-	Up	66 70	66 10	<u>30</u> 50	Condition of track. (86/3)

SECTION A - TEMPORARY SPEED RESTRICTIONS - continued

Location	Lines affected	Mileage at or between				Restr- iction m.p.h.	Remarks
		M.	Ch.	M.	Ch.		
<u>NORWICH TO LOWESTOFT</u>							
28 Thorpe Jn and Whitlingham Jn	Down	Up	0 36	0 44	20	Trackwork. (85/20)	
<u>REEDHAM JN TO YARMOUTH</u>							
29 Reedham Jn and Berney Arms	Single		13 52	15 60	30	Condition of track. (86/13)	
<u>BETHNAL GREEN JN. TO KING'S LYNN</u>							
30 Brimsdown and Waltham Cross	Down	Up	11 54	12 12	20	Trackwork.	
31 Slupe Lane LC and Cheshunt Station	-	Up	15 55	15 35	50	Condition of track. (86/4)	
32 Broxbourne Jn and Roydon	Down	Up	19 43 †	20 05	20	Trackwork. (86/19)	
33 Sawbridgeworth and Harlow Mill	-	Up	24 76	24 70	60	Condition of track. (86/16)	
34 Shelford	-	Up	52 37	52 27	40	Platform work. (86/15)	
<u>COLDHAM LANE JN TO HAUGHLEY JN</u>							
35 Elmswell	Down	Up	37 00	37 14	40	Trackwork. (86/18)	
36 Haughley Jn and Elmswell	-	Up	38 20	37 60	20	Trackwork. (86/11)	
<u>ELY NORTH JN TO PETERBOROUGH, CRESCENT JN</u>							
37 Third Drove LC and Welney Road LC	Down	Up	78 00	78 60	20	Condition of track. (85/58)	

SECTION A - TEMPORARY SPEED RESTRICTIONS - continued

Location	Lines affected	Mileage		Restr- iction m.p.h.	Remarks
		at or between M. Ch. M. Ch.			
<u>ELY NORTH JN TO PETERBOROUGH, CRESCENT JN - continued</u>					
38 Manea and Stonea	Down -	81 30	82 03	20	Trackwork. (86/18) <u>Until 14 00</u> <u>Friday 15</u> <u>August.</u>
39 Stonea and Manea	- Up	81 55	81 30	20	Trackwork. (86/18) <u>Until 14 00</u> <u>Friday 15</u> <u>August.</u>
40 March East Jn and Badgeney Road LC	- Up Main	85 40	85 29	20	Trackwork. (85/54) <u>Warning board positioned at signal ME.45.</u> <u>Additional warning board provided on the March East Jn. to Wisbech line, positioned at signal ME.52.</u>

Warning board at 100m. 23chs. (on the Down line) applies only to trains proceeding over the Two-Way Goods line to Fly Ash Inspection Siding connection at Peterborough Station (North).

ELY NORTH JN TO TROWSE LOWER JN

41 Brandon and Santon LC	Down -	87 09	87 61	20	Trackwork. (86/17)
42 Eaton LC and Trowse Lower Jn	Down -	121 60	121 64	40	Condition of bridge. (No. 1640/1640A). (85/43)

FENCHURCH STREET TO SHOEBURYNESS

43 Laindon	Down Up	22 53	23 04	20	Trackwork. (86/14)
------------	---------	-------	-------	----	-----------------------

SECTION A - TEMPORARY SPEED RESTRICTIONS - continued

Location	Lines affected		Mileage		Restr- iction m.p.h.	Remarks
			at or between M. Ch. M. Ch.			
<u>UPPER HOLLOWAY TO BARKING, TILBURY LINE JN WEST</u>						
44 South Tottenham East Jn and Black Horse Road	Down	-	6 45	6 57	20	Condition of track. (85/18)
<u>BARKING, TILBURY LINE JN EAST TO TILBURY RIVERSIDE</u>						
45 Dagenham Dock and Barking Tilbury Line Jn East	-	Up Main	9 60 †	8 05	20	Trackwork. (86/1)
<u>TILBURY RIVERSIDE TO PITSEA</u>						
46 Stanford-le- Hope and Gardners LC	Down	-	30 11	30 60	40	Condition of track. (86/1)

SECTION B

TEMPORARY ENGINEERING WORKS

At or between	Lines affected	Remarks
<u>LIVERPOOL STREET TO NORWICH</u>		
UNTIL FURTHER NOTICE		
47	Liverpool Street Station	Platform 1 08 00 to 16 00. Bridgework (No. 7). (85/39)
48	Liverpool Street Station	Platforms 1 to 10 Inc. Repairs to station roof. Mechanical equipment in use. (84/41)
49	Liverpool Street Station	Platforms 1 to 18 inc. Cleaning track. (85/21)
50	Liverpool Street Station	Platforms 8 and 10 Platform work and construction work. Mechanical equipment in use. (86/14)
51	Bethnal Green Station	Down Main and Down and Up Suburban 08 00 to 16 00. Demolition work. (See Section 'D'). (85/41)
52	Bow Jn.	All 07 30 to 18 00. Undertrack excavation and earthwork 2m. 70chs. Mechanical equipment in use. (85/31)
53	Stratford and Bow Jn.	Up Electric 07 30 to 18 00. Construction work. Mechanical equipment in use. (85/62)
54	Forest Gate Jn. and Ilford	All 07 00 to 18 00. Bridgework (No. 75A), 7m. 08chs. Mechanical equipment in use. (85/20)
55	Ilford Station	All 08 00 to 17 00. Repairs to station roof and painting station. (86/2)
56	Romford Jn and Gidea Park	All Bridgework (No. 102B). 12m. 48chs. Crane and mechanical equipment in use. (85/54)
57	Ingatestone and Chelmsford	Down and Up 07 30 to 18 00. Construction of bridge (No. 143A) 26m. 51chs. Mechanical equipment in use. (84/35)
58	Chelmsford and Hatfield Peverel	Down and Up 07 30 to 16 00. Earthwork 35m. 53chs. (85/27)

SECTION B - TEMPORARY ENGINEERING WORKS - continued

<u>At or between</u>	<u>Lines</u> <u>affected</u>	<u>Remarks</u>
<u>LIVERPOOL STREET TO NORWICH - continued</u>		
UNTIL FURTHER NOTICE - continued		
59 Colchester Jn. and Ardleigh LC	Down	08 00 to 17 00. Earthwork and formation renewal. 52m. 25chs. and 53m. 75chs. Mechanical equipment in use. (85/41)
60 Manningtree North Jn. and Bentley LC	Down and Up <u>Between Trains</u>	07 00 to 18 00. Tree felling, bridgework (No. 229) and earthwork 60m. 06chs. and 61m. 06chs. Crane and mechanical equipment in use. (85/15)
61 Ipswich Goods Jn and Needham Market	Down Main	08 00 to 16 00. Construction work. 69% and 76m.p. (86/19)
62 East Suffolk Jn. and Claydon LC	Down and Up	08 00 to 16 00. Bridgework (No.254A). 70m. 17chs. (85/58)
63 Mellis	Down and Up	07 30 to 18 00. Demolition work 91½mp. Mechanical equipment in use. (86/12)
64 Mellis and Trowse Lower Jn	All <u>Between Trains</u>	07 30 to 18 00. Signalling work. Points and signals disconnected. (86/15)
65 Diss and Mellis	Up	08 00 to 15 00. Construction work. 94m. 05chs. and 94m.p. (86/17)
66 Diss	Down and Up	07 00 to 19 00. Earthwork. Crane and mechanical equipment in use. (85/27)
67 Diss and Ardley End LC	Down and Up	Bridgework (No. 315). 95m. 29chs. (86/16)
68 Diss and Tivetshall Jn	Down and Up	07 30 to 18 00. Demolition work 97m 50chs. Mechanical equipment in use. (86/12)
69 Tivetshall Jn	Down and Up	07 30 to 18 00. Demolition work. 100½m.p. Mechanical equipment in use. (86/8)

SECTION B - TEMPORARY ENGINEERING WORKS - continued

At or between	Lines affected	Remarks
<u>LIVERPOOL STREET TO NORWICH - continued</u>		
UNTIL FURTHER NOTICE - continued		
70 Tivetshall Jn and Swainsthorpe	Down and Up <u>Between Trains</u>	07 30 to 18 00. Bridgework (Nos. 328 and 331A) and demolition work. 103m. 13chs. and 104m. 59chs. Crane and mechanical equipment in use. (86/8)
71 Swainsthorpe	Down and Up <u>Between Trains</u>	07 30 to 18 00. Demolition work. 109½m.p. Mechanical equipment in use. (86/8)
72 Trowse Lower Jn and Norwich Station	All <u>Between Trains</u>	07 00 to 17 00. Construction work (overhead line), earthwork, track maintenance and signalling work. Points and signals disconnected. (86/7)
73 Trowse Swing Bridge	Down and Up <u>Between Trains</u>	Bridgework (No. 356). 123m. 36chs. Crane and mechanical equipment in use. (85/33)
74 Trowse Swing Bridge and Thorpe Jn	Down and Up <u>Between Trains</u>	07 30 to 18 00. Construction work. 123½m.p. Crane and mechanical equipment in use. (86/3)
75 Norwich Station	All	Track renewal, platform work and earthwork. Crane and mechanical equipment in use. (85/62)
* FRIDAY/SATURDAY 8/9 AUGUST		
76 Bethnal Green and Stratford (London End)	Down and Up Electric BLOCKED	23 59 to 05 00. Overhead line work. Mechanical equipment in use. <u>Isolation of electrical sections 309A, 310B. Trains to travel over Main lines.</u>
77 Trowse Yard and Norwich Station	Down Main/'W' line BLOCKED	23 00 to 04 45. Track maintenance and track renewal. Crane and mechanical equipment in use. <u>Single line working over 'C' line/Up Main line.</u>

SECTION B - TEMPORARY ENGINEERING WORKS - continued

At or between	Lines affected	Remarks
---------------	----------------	---------

LIVERPOOL STREET TO NORWICH - continued

SATURDAY 9 AUGUST

78	Liverpool Street and Bethnal Green	Down and Up Suburban)08 00 to 17 00. Demolition work.)0m.p. and 1m. 10chs.))
	Liverpool Street Station	Platforms 1 to 10 inc.)))
79	Bethnal Green and Bow Jn	Down and Up Main BLOCKED	08 00 to 18 00. Undertrack excavation. <u>Isolation of electrical sections 311B, 312B. Trains to travel over Electric lines.</u>
80	Marks Tey Station and Kelvedon	Up BLOCKED	00 01 to 04 45. Overhead line work. Mechanical equipment in use. <u>Isolation of electrical sections 337A, 339H. Single line working over Down line.</u>

SATURDAY 9 TO SUNDAY 10 AUGUST

81	Bethnal Green and Forest Gate Jn	Down and Up Electric BLOCKED	23 00 Sat to 23 00 Sun. Track maintenance, track renewal, construction work, overhead line work, signalling work and bridgework (No.28). Mechanical equipment in use. <u>Isolation of electrical sections 309A, 310B, 317CD, 318AB. Trains to travel over Main lines.</u>
82	Gidea Park Jn and Shenfield (London End)	Down and Up Main BLOCKED)21 15 Sat to 22 00 Sun. Track renewal, track maintenance and overhead line work. Mechanical equipment in use. <u>Isolation of electrical sections 331D, 332A.</u>
	Shenfield	Platform 1/ Up Passenger Loop BLOCKED)Trains to travel over Electric lines.))

SATURDAY/SUNDAY 9/10 AUGUST

83	New Hall G.F. and Witham (London End)	Up BLOCKED Down BLOCKED	23 10 to 06 00)Track maintenance and)unloading materials. 23 50 to 07 00)Mechanical equipment)in use. <u>Possession to be given up for passage of trains.</u>
----	---------------------------------------	----------------------------------	--

SECTION B - TEMPORARY ENGINEERING WORKS - continued

At or between	Lines affected	Remarks
<u>LIVERPOOL STREET TO NORWICH - continued</u>		
SATURDAY/SUNDAY 9/10 AUGUST - continued		
84 Witham (London End) and Kelvedon	Up Main BLOCKED Down Main BLOCKED	23 00 to 16 00)Track maintenance,)track renewal and 23 55 to 07 15)overhead line work.)Crane and mechanical)equipment in use.) <u>23 55 Sat to 07 15</u>) <u>Possession to be given</u>) <u>up for passage of 1Y02</u>) <u>02 20 Liverpool Street</u>) <u>to Stowmarket and 1F46</u>) <u>03 15 Liverpool Street</u>) <u>to Witham over Down</u>) <u>Main line.</u>) <u>07 15 to 16 00 Sun.</u>) <u>Single line working</u>) <u>over Down Main line.</u>
85 Halifax Jn. and Manningtree South Jn.	Up BLOCKED	23 00 to 07 30. Trimming lineside vegetation. Mechanical equipment in use.
86 Ipswich Station	Platform 4 BLOCKED	23 15 to 08 00. Earthwork and drainage. Mechanical equipment in use. <u>Trains to be replatformed as necessary.</u>
87 Haughley Jn. and Tivetshall Jn	Down and Up BLOCKED	23 45 to 07 00. Demolition work and unloading materials.
88 Tivetshall Jn. and Swainsthorpe	Up BLOCKED Down BLOCKED	22 00 to 16 00)Drainage, loading)materials and 23 55 to 07 00)demolition work.)Mechanical equipment)in use. <u>07 00 to</u>) <u>16 00 Sun. Single line</u>) <u>working over Down</u>) <u>line.</u>

SECTION B - TEMPORARY ENGINEERING WORKS - continued

At or between	Lines affected	Remarks
<u>LIVERPOOL STREET TO NORWICH - continued</u>		
<u>SATURDAY/SUNDAY 9/10 AND SUNDAY 10 AUGUST</u>		
89	Liverpool Street and Bethnal Green	Down and Up Suburban BLOCKED
		23 15 Sat to 18 00)
		Repairs to station roof and overhead line work. Crane and mechanical equipment in use. Isolation of electrical sections 305 and 306. Trains to travel over Main or Electric lines and to be replatformed as necessary.
	Liverpool Street Station	Platforms 9 and 10 BLOCKED to electric trains
		23 15 Sat to 04 15)
		Platforms 1 to 8 incl. BLOCKED
		23 15 Sat to 18 00)
		Locomotive Holding Sidings BLOCKED to electric trains
		23 15 Sat to 18 00)
		Platforms 9 and 10 BLOCKED
		04 15 to 18 00 Sun)
)
)
90	Kelvedon and Marks Tey Station	Up Main BLOCKED Down Main BLOCKED
		23 15 Sat to 06 30)
		Track maintenance and track renewal.
		00 05 to 07 30 Sun)
		Mechanical equipment in use. Possession to be given up for passage of trains.
91	Trowse Yard and Norwich Station	'C' line/ Up Main BLOCKED
		23 00 Sat to 07 00)
		Track maintenance, track renewal and signalling work.
		Down Main/ 'W' line BLOCKED
		23 00 Sat to 16 00)
		Crane and mechanical equipment in use. 23 00 Sat to 07 00 Possession to be given up for passage of 1P04 02 10 Liverpool Street to Yarmouth over Up Main/'C' line under single line working. 07 00 to 16 00 Sun Single line working over 'C' line/Up Main line. (See Section 'C').
	Trowse Swing Bridge and Thorpe Jn.	Up Main
		07 00 to 16 00 Sun)
)
)

SECTION B - TEMPORARY ENGINEERING WORKS - continued

At or between	Lines affected	Remarks
<u>LIVERPOOL STREET TO NORWICH - continued</u>		
SUNDAY 10 AUGUST		
92 Forest Gate Jn and Ilford Car Sheds (Country End Jn)	Down and Up Main, Down and Up Electric and Down and Up Avoiding (and Aldersbrook Up CS) BLOCKED to electric trains)00 15 to 06 35. In connection with engineering work between Manor Park and Ilford Station. <u>Isolation of electrical sections 321DEFG, 322ABDEF, 323D, 324AB.</u>
Ilford	Platform 5 and Back Road BLOCKED to electric trains)))))))))))
93 Manor Park and Ilford Station	Down and Up Main and Down and Up Electric BLOCKED	00 15 to 06 35. Bridgework (No. 75A) 7m. 08chs. Crane and mechanical equipment in use. <u>Diesel trains to travel over Avoiding lines.</u>
94 Chelmsford and New Hall G.F.	Down and Up BLOCKED	00 45 to 07 00. Track maintenance. Mechanical equipment in use. <u>Possession to be given up for passage of 1Y02 02 20 Liverpool Street to Stowmarket and 1F46 03 15 Liverpool Street to Witham over Down line.</u>
95 Witham (London End) and Hill House G.F.	All BLOCKED to electric trains	00 01 to 07 15. In connection with engineering work. <u>Isolation of electrical sections 337 and 338.</u>
96 Colchester and Ardleigh LC	Up Main BLOCKED Down Main BLOCKED	00 15 to 07 45)Track maintenance.)Mechanical equipment in use. <u>00 15 to 07 45 Possession to be given up for passage of 1Y02 02 20 Liverpool Street to Stowmarket over Up Main line under single line working.</u>)07 45 to 16 00 Sun)Single line working)over Up Main line.

SECTION B - TEMPORARY ENGINEERING WORKS - continued

At or between	Lines affected	Remarks
---------------	----------------	---------

LIVERPOOL STREET TO NORWICH - continued

SUNDAY 10 AUGUST - continued

97	Ardleigh LC and Manningtree South Jn.	Down and Up BLOCKED	00 25 to 07 45. Level crossing road repairs (Ardleigh LC). Mechanical equipment in use. <u>Possession to be given up for passage of 1Y02 02 20 Liverpool Street to Stowmarket over Down line.</u>
98	Manningtree South Jn. and East Suffolk Jn	All BLOCKED to electric trains	00 45 to 07 30. In connection with engineering work. <u>Isolation of electrical sections 343 and 344.</u>

SUNDAY/MONDAY 10/11 AUGUST

99	Liverpool Street Station	Platforms 11 and 12 (and approaches) and connections between Main lines and Platforms 13 and 14 BLOCKED to electric trains	23 15 to 05 00. Repairs to station roof. <u>Isolation of electrical sections 304ABE. Electric trains travelling to/from Platforms 13 and 14 to travel over Electric lines. Electric trains to be replatformed as necessary.</u>
100	Diss and Tivetshall Jn.	Down BLOCKED	23 00 to 04 00. Unloading materials. <u>Single line working over Up line.</u>

SUNDAY 10 TO FRIDAY 15 AUGUST

101	Norwich and Whitlingham Jn	'A' and 'E' lines/Down and Up Lowestoft/ Main BLOCKED)23 30 Sun to Thu to 05 00 Mon to Fri.)Construction work (overhead line).)Crane and mechanical equipment in)use. <u>Possession to be given up for)passage of trains.</u>)))
	Norwich Station	Platforms 4, 5 and 6 BLOCKED)))

MONDAY 11 AUGUST

102	Shenfield and Ingatstone	Down and Up Main	10 30 to 15 30. Signalling work.
-----	-----------------------------	------------------	----------------------------------

SECTION B - TEMPORARY ENGINEERING WORKS - continued

At or between	Lines affected	Remarks
<u>LIVERPOOL STREET TO NORWICH - continued</u>		
MONDAY 11 AUGUST - continued		
103 Shenfield and Church Lane LC	Down and Up Main BLOCKED	01 00 to 04 15. Overhead line work. <u>Possession to be given up for passage of Diesel trains.</u>
104 Shenfield and Chelmsford (London End)	All BLOCKED to electric trains	01 00 to 04 15. In connection with overhead line work between Shenfield and Church Lane L.C. <u>Isolation of electrical sections 331A, 332D, 333 and 334.</u>
105 East Suffolk Jn. and Haughley Jn.	All BLOCKED to electric trains	01 30 to 04 30. In connection with overhead line work between Claydon LC and Stowmarket Station. <u>Isolation of electrical sections 345, 346, 347 and 348.</u>
106 Claydon LC and Stowmarket Station	Down and Up BLOCKED	01 30 to 04 30. Overhead line work. <u>Possession to be given up for passage of Diesel trains.</u>
MONDAY/TUESDAY 11/12 AUGUST		
107 Bow Jn. and Forest Gate Jn.	Down and Up Electric BLOCKED	23 59 to 05 00. Track maintenance. Mechanical equipment in use. <u>Trains to travel over Main lines.</u>
108 Barham and Stowmarket Station (London End)	Down Main BLOCKED	22 30 to 04 00. Track maintenance. Mechanical equipment in use. <u>Single line working over Up Main line.</u>
MONDAY 11 TO WEDNESDAY 13 AUGUST		
109 Trowse Lower Jn. and Trowse Swing Bridge	Down and Up BLOCKED	23 00 Mon and Tue to 05 00 Tue and Wed. Track renewal. Crane and mechanical equipment in use. <u>Possession to be given up for passage of trains.</u>
MONDAY 11 TO THURSDAY 14 AUGUST		
110 Gidea Park Jn and Shenfield (London End Jn)	Down and Up Main BLOCKED	10 15 to 15 15 daily. Track maintenance. Mechanical equipment in use. <u>Trains to travel over Electric lines.</u>

SECTION B - TEMPORARY ENGINEERING WORKS - continued

At or between	Lines affected	Remarks
---------------	----------------	---------

LIVERPOOL STREET TO NORWICH - continued

MONDAY 11 TO FRIDAY 15 AUGUST

111	Liverpool Street and Bethnal Green	Down and Up Suburban) 08 00 to 17 00 daily. Demolition work. 0m.p. and 1m. 10chs.
	Liverpool Street Station	Platforms 1 to 10 inc.)
112	New Hall G.F. and Witham	Down BLOCKED	23 30 Mon to Thu to 05 30 Tue to Fri. Track maintenance. <u>Possession to be given up for passage of trains.</u>
113	Claydon LC	Down Goods Loop	08 00 to 16 00 daily. Track maintenance and loading materials.

TUESDAY 12 AUGUST

114	Liverpool Street Station	Platform 10 BLOCKED	10 00 to 15 30. Repairs to station roof. Mechanical equipment in use. <u>Isolation of electrical sections 305H. Trains to be replatformed as necessary.</u>
-----	--------------------------	---------------------	---

TUESDAY/WEDNESDAY 12/13 AUGUST

115	Barham and East Suffolk Jn	Up Main BLOCKED	23 35 to 05 45. Track maintenance. Mechanical equipment in use. <u>Single line working over Down Main line.</u>
-----	----------------------------	-----------------	---

TUESDAY 12 TO FRIDAY 15 AUGUST

116	Witham and Kelvedon	Down BLOCKED	00 01 to 04 50 daily. Overhead line work. Mechanical equipment in use. <u>Isolation of electrical sections 338BCD. Single line working over Up line.</u>
-----	---------------------	--------------	--

TUESDAY 12 TO SATURDAY 16 AUGUST

117	Bethnal Green and Forest Gate Jn	Down and Up Electric BLOCKED	23 00 Tue to Fri to 05 00 Wed to Sat. Overhead line work and track maintenance. Mechanical equipment in use. <u>Isolation of electrical sections 309A, 310B. Trains to travel over Main lines.</u>
-----	----------------------------------	------------------------------	--

SECTION B - TEMPORARY ENGINEERING WORKS - continued

At or between	Lines affected	Remarks
---------------	----------------	---------

LIVERPOOL STREET TO NORWICH - continued

WEDNESDAY 13 TO FRIDAY 15 AUGUST

118	East Suffolk Jn and Claydon LC	Down BLOCKED	22 30 Wed and Thu to 04 00 Thu and Fri. Track maintenance. Mechanical equipment in use. <u>Single line working over Up line.</u>
119	Swainsthorpe and Trowse Upper Jn	Down and Up BLOCKED	23 00 Wed and Thu to 05 00 Thu and Fri. Track renewal. Crane and mechanical equipment in use. <u>Possession to be given up for passage of trains.</u>

THURSDAY 14 AUGUST

120	Liverpool Street Station	Platform 10 BLOCKED	10 00 to 15 30. Repairs to station roof. Mechanical equipment in use. <u>Isolation of electrical sections 305H. Trains to be replatformed as necessary.</u>
-----	--------------------------	------------------------	---

NAVARINO ROAD JN TO NORTH WOOLWICH

UNTIL FURTHER NOTICE

121	Highbury and Homerton	All	07 30 to 18 00. Earthwork and construction work. Mechanical equipment in use.
-----	-----------------------	-----	---

(86/1)

SUNDAY 10 AUGUST

122	Navarino Road Jn and Channelsea North Jn	Down and Up BLOCKED	00 01 to 08 00. Construction work (overhead line). Crane and mechanical equipment in use. <u>Isolation of electrical sections 707 and 708. Possession to be given up for passage of 1P04 02 10 Liverpool Street to Yarmouth (diverted) and 1H02 03 10 Liverpool Street to King's Lynn (diverted) over Up line.</u>
123	Channelsea North Jn and Stratford Central Jn West	Down and Up	00 01 to 08 00. Construction work (overhead line). <u>Isolation of electrical sections 705C, 706A.</u>

SECTION B - TEMPORARY ENGINEERING WORKS - continued

At or between	Lines affected	Remarks
---------------	----------------	---------

NAVARINO ROAD JN TO NORTH WOOLWICH - continued

SUNDAY 10 AUGUST - continued

124 Stratford Low Level and North Woolwich	All BLOCKED	00 30 to 08 00. Track maintenance. <u>Isolation of electrical sections 703 and 704.</u>
--	----------------	---

STRATFORD, LEA JN TO HIGH MEADS JN

SUNDAY 10 AUGUST

125 Lea Jn and High Meads Jn	Down and Up BLOCKED	00 01 to 08 00. Construction work (overhead line). Crane and mechanical equipment in use.
------------------------------	------------------------	---

CHANNELSEA SOUTH JN TO STRATFORD CENTRAL JN WEST

UNTIL FURTHER NOTICE

126 Channelsea South Jn and Stratford Central Jn West	Down and Up BLOCKED to electric trains	In connection with engineering work. (86/14)
---	---	--

SUNDAY 10 AUGUST

127 Channelsea North Jn and Stratford Central Jn West	Down and Up	00 01 to 08 00. Construction work (overhead line). <u>Isolation of electrical sections 705C, 706A.</u>
---	-------------	--

FOREST GATE JN TO WOODGRANGE PARK JN

SUNDAY 10 AUGUST

128 Forest Gate Jn and Barking Tilbury Line Jn West	Down and Up BLOCKED to electric trains	00 50 to 18 00. In connection with engineering work. <u>Isolation of electrical sections 512AB, 513EF.</u>
---	---	--

SECTION B - TEMPORARY ENGINEERING WORKS - continued

At or between	Lines affected	Remarks
<u>SHENFIELD JN TO SOUTHEND VICTORIA</u>		
UNTIL FURTHER NOTICE		
129	Billericay Down and Up	07 30 to 17 30. Construction work and platform work. Mechanical equipment in use. (86/19)
130	Wickford Station	All Platform work and earthwork. (85/63)
131	Wickford Jn	All 08 00 to 17 00. Signalling work. (85/41)
132	Rayleigh and Hockley	Down 08 00 to 17 00. Earthwork 34½ and 34¾ m.p. Mechanical equipment in use. (85/61)
133	Southend Victoria Station	All 08 00 to 18 00. Repairs to station roof. <u>From 08 00 Monday 11 August.</u> (86/20)

SATURDAY 9 AUGUST

134	Southend Victoria Station	Platforms 2 and 3 BLOCKED	08 00 to 18 00. Repairs to station roof. <u>Isolation of electrical sections 375A, 376H. Trains to be replatformed as necessary.</u>
-----	---------------------------------	---------------------------------	--

WICKFORD JN TO SOUTHMINSTER

UNTIL FURTHER NOTICE

135	Wickford Jn	All	08 00 to 17 00. Signalling work. (85/41)
136	Fambridge Station	Single	07 30 to 18 00. Platform work. (85/55)
137	Burnham-on- Crouch	Single	07 30 to 18 00. Earthwork. 43m 24chs. (85/30)

SATURDAY 9 AUGUST

138	Wickford Jn and Southminster	Single BLOCKED	00 01 to 04 45. Overhead line work. Mechanical equipment in use. <u>Isolation of electrical sections 377.</u>
-----	------------------------------------	-------------------	--

SECTION B - TEMPORARY ENGINEERING WORKS - continued

At or between	Lines affected	Remarks
---------------	----------------	---------

WICKFORD JN TO SOUTHMINSTER - continued

SUNDAY 10 AUGUST

139 Wickford Jn and Southminster	Single BLOCKED	00 30 to 08 30. Track maintenance. Mechanical equipment in use.
----------------------------------	-------------------	---

TUESDAY 12 AND WEDNESDAY 13 AUGUST

140 Wickford Jn and Southminster	Single BLOCKED	00 01 to 04 45 daily. Overhead line work. Mechanical equipment in use. <u>Isolation of electrical sections 377.</u>
----------------------------------	-------------------	---

FRIDAY 15 AUGUST

141 Wickford Jn and Southminster	Single BLOCKED	00 01 to 04 45. Overhead line work. Mechanical equipment in use. <u>Isolation of electrical sections 377.</u>
----------------------------------	-------------------	---

WITHAM TO BRAINTREE

UNTIL FURTHER NOTICE

142 Witham and Braintree	Single	07 00 to 18 00. Construction work (Bridge No. 2102B). (86/19)
--------------------------	--------	--

SUNDAY 10 AUGUST

143 Witham and Braintree	Single BLOCKED to electric trains	00 01 to 07 15. In connection with engineering work between Witham and Kelvedon. <u>Isolation of electrical sections 379.</u>
--------------------------	--------------------------------------	---

MONDAY 11 TO FRIDAY 15 AUGUST

144 Witham and Braintree	Single	07 00 to 17 00 daily. Bridgework (No. 2105A). 23m. 37chs.
--------------------------	--------	---

TUESDAY 12 TO FRIDAY 15 AUGUST

145 Witham and Braintree	Single BLOCKED	00 01 to 04 50 daily. Bridgework (No. 2105A). 23m. 37chs. <u>Isolation of electrical sections 379.</u>
--------------------------	-------------------	--

SECTION B - TEMPORARY ENGINEERING WORKS - continued

At or between	Lines affected	Remarks
<u>COLCHESTER TO CLACTON</u>		
UNTIL FURTHER NOTICE		
146 Colchester Jn and East Gate Jn	Down Clacton Avoiding	08 00 to 17 00. Earthwork. 52m. 25chs. and 52m. 29chs. Mechanical equipment in use. (85/38)
SATURDAY/SUNDAY 9/10 AUGUST		
147 Colchester Jn and Alresford	Down and Up BLOCKED	23 30 to 07 45. Level crossing road repairs (East Gate and Hythe LCs). 53m. 14chs. and 53m. 53chs. Mechanical equipment in use. <u>Possession to be given up for passage of Engineers' trains.</u>
148 Alresford and Great Bentley	Up BLOCKED Down BLOCKED	23 30 to 07 15) Track maintenance,) track renewal and 23 30 to 16 00) overhead line work.) Crane and mechanical) equipment in use.) <u>07 15 to 16 00 Sun.</u>) <u>Isolation of electrical</u>) <u>sections 384A. Single</u>) <u>line working over Up</u>) <u>line.</u>
SUNDAY 10 AUGUST		
149 Alresford and Clacton	All BLOCKED to electric trains	00 10 to 07 15. In connection with engineering work between Alresford and Great Bentley. <u>Isolation of electrical sections 383, 384, 385 and 386.</u>
SUNDAY/MONDAY 10/11 AUGUST		
150 East Gate Jn and Thorpe-le-Soken	Down and Up BLOCKED	23 30 to 04 45. Track maintenance. Mechanical equipment in use.

SECTION B - TEMPORARY ENGINEERING WORKS - continued

At or between	Lines affected	Remarks
---------------	----------------	---------

COLCHESTER TO CLACTON - continued

MONDAY 11 TO WEDNESDAY 13 AUGUST

151	East Gate Jn and Thorpe-le-Soken	Down BLOCKED to electric trains	23 30 Mon and Tue to 04 45 Tue and Wed. In connection with engineering work. <u>Isolation of electrical sections 384.</u>
-----	----------------------------------	---------------------------------------	---

MONDAY 11 TO FRIDAY 15 AUGUST

152	East Gate Jn and Thorpe-le-Soken	Down and Up BLOCKED	23 30 Mon to Thu to 04 45 Tue to Fri. Track maintenance and trimming lineside vegetation. Mechanical equipment in use. <u>Possession to be given up for passage of Freight trains to/from Hythe.</u>
-----	----------------------------------	------------------------	--

WEDNESDAY 13 TO FRIDAY 15 AUGUST

153	Thorpe-le-Soken and East Gate Jn	Up BLOCKED to electric trains	23 30 Wed and Thu to 04 45 Thu and Fri. In connection with engineering work. <u>Isolation of electrical sections 383.</u>
-----	----------------------------------	-------------------------------------	---

THORPE-LE-SOKEN TO WALTON-ON-NAZE

SUNDAY 10 AUGUST

154	Thorpe-le-Soken and Walton-on-Naze	Single BLOCKED to electric trains	00 10 to 07 15. In connection with engineering work between Alresford and Great Bentley. <u>Isolation of electrical sections 387.</u>
-----	------------------------------------	---	---

MANNINGTREE SOUTH JN TO HARWICH

UNTIL FURTHER NOTICE

155	Mistley Station	Down and Up	07 30 to 16 00. Platform work. Mechanical equipment in use. (85/50)
156	Wrabness and Mistley	Up	07 30 to 17 00. Earthwork. 64m. 46chs. and 64m. 15chs. Mechanical equipment in use. (85/65)

SECTION B - TEMPORARY ENGINEERING WORKS - continued

At or between	Lines affected	Remarks
<u>MANNINGTREE SOUTH JN TO HARWICH - continued</u>		
UNTIL FURTHER NOTICE - continued		
157 Wrabness Station	Down and Up	07 30 to 18 00. Platform work. Mechanical equipment in use. (85/58)
158 Parkeston Quay Station	All <u>Between Trains</u>	07 30 to 18 00. Platform work. Mechanical equipment in use. (85/58)
159 Parkeston Quay Yard	All	07 30 to 16 00. Track maintenance in connection with remodelling of sidings. Mechanical equipment in use. (84/10)
160 Parkeston West and Harwich Town	Single	07 30 to 18 00. Track maintenance, track renewal and earthwork. 70 $\frac{1}{2}$ m.p. Mechanical equipment in use. (85/27)

EAST SUFFOLK JN TO OULTON BROAD NORTH JN

UNTIL FURTHER NOTICE

161 Melton and Wickham Market	Single	07 00 to 18 00. Bridgework (No. 426). 81m. 11chs. Crane in use. (85/26)
162 Oulton Broad North Jn	All	08 00 to 17 00. Signalling work. (85/41)

SATURDAY/SUNDAY 9/10 AUGUST

163 East Suffolk Jn and Derby Road	All BLOCKED	23 15 to 07 00. Track maintenance. Mechanical equipment in use.
164 Woodbridge and Westerfield Jn	Up BLOCKED	23 10 to 10 00. Track maintenance and unloading materials. Mechanical equipment in use.

MONDAY/TUESDAY 11/12 AUGUST

165 Westerfield Jn and Woodbridge	Down and Up BLOCKED	23 15 to 08 15. Track maintenance and unloading rails. Mechanical equipment in use.
-----------------------------------	---------------------	---

SECTION B - TEMPORARY ENGINEERING WORKS - continued

At or between	Lines affected	Remarks
---------------	----------------	---------

EAST SUFFOLK JN TO OULTON BROAD NORTH JN - continued

MONDAY 11 TO THURSDAY 14 AUGUST

166	Saxmundham and Halesworth	Down and Up BLOCKED	21 15 Mon to Wed to 05 45 Tue to Thu. Track maintenance. Mechanical equipment in use.
-----	---------------------------	------------------------	--

MONDAY 11 TO FRIDAY 15 AUGUST

167	Halesworth and Oulton Broad North Jn	Single	08 00 to 16 00 daily. Level crossing work.
-----	--------------------------------------	--------	--

TUESDAY 12 AUGUST

168	Woodbridge	Single	10 15 to 15 00. Signalling work. <u>(See Section 'C').</u>
-----	------------	--------	---

TUESDAY 12 TO THURSDAY 14 AUGUST

169	Westerfield Jn and Woodbridge	Down and Up BLOCKED	23 15 Tue and Wed to 08 15 Wed and Thu. Track maintenance. Mechanical equipment in use.
-----	-------------------------------	------------------------	---

WESTERFIELD JN TO FELIXSTOWE

UNTIL FURTHER NOTICE

170	Westerfield Jn and Derby Road	Single	08 00 to 16 00. Earthwork. 73m. 13chs. and 73 $\frac{1}{2}$ m.p. (85/61)
171	Derby Road and Felixstowe Beach Jn	Single	07 30 to 17 00. Earthwork. 82 $\frac{1}{2}$ and 83m.p. Mechanical equipment in use. (86/1)

SATURDAY/SUNDAY 9/10 AUGUST

172	East Suffolk Jn and Derby Road	All BLOCKED	23 15 to 07 00. Track maintenance. Mechanical equipment in use.
-----	--------------------------------	----------------	---

SECTION B - TEMPORARY ENGINEERING WORKS - continued

At or between	Lines affected	Remarks
---------------	----------------	---------

SAXMUNDHAM JN TO SIZEWELL

MONDAY 11 TO FRIDAY 15 AUGUST

173	Saxmundham Jn and Sizewell	Single	08 00 to 16 00 daily. Track maintenance.
-----	----------------------------	--------	--

NORWICH TO LOWESTOFT

UNTIL FURTHER NOTICE

174	Norwich Station	All	Track renewal, platform work and earthwork. Crane and mechanical equipment in use. (85/62)
175	Norwich Station and Trowse Lower Jn	All <u>Between Trains</u>	07 00 to 17 00. Construction work (overhead line), earthwork, track maintenance and signalling work. Points and signals disconnected. (86/7)
176	Thorpe Jn	All	08 00 to 17 00. Earthwork and track maintenance. (85/22)
177	Whitlingham Jn and Thorpe Jn	Up	07 30 to 17 00. Earthwork 1½ and 1m.p. Mechanical equipment in use. (86/13)
178	Whitlingham Jn and Brundall Jn	Down and Up	07 00 to 16 00. Signalling work.
179	Brundall Jn and Reedham Swing Bridge	Down and Up	07 00 to 18 00. Earthwork. 7m. 34chs. and signalling work. (85/16)
180	Oulton Broad North Jn	All	08 00 to 17 00. Signalling work. (85/41)

FRIDAY/SATURDAY 8/9 AUGUST

181	Trowse Yard and Norwich Station	Down Main/'W' line BLOCKED	23 00 to 04 45. Track maintenance and track renewal. Crane and mechanical equipment in use. <u>Single line working over 'C' line/Up Main line.</u>
-----	---------------------------------	-------------------------------	--

SECTION B - TEMPORARY ENGINEERING WORKS - continued

At or between	Lines affected	Remarks
---------------	----------------	---------

NORWICH TO LOWESTOFT - continued

SATURDAY/SUNDAY 9/10 AND SUNDAY 10 AUGUST

182	Trowse Yard and Norwich Station	'C' line/ Up Main BLOCKED Down Main/ 'W' line BLOCKED	23 00 Sat to 07 00) Track maintenance,) track renewal and) signalling work. 23 00 Sat to 16 00) Crane and) mechanical) equipment in use.) <u>23 00 Sat to 07 00</u>
	Trowse Swing Bridge and Thorpe Jn	Up Main	07 00 to 16 00 Sun) <u>Possession to be given up for passage of 1P04 02 10 Liverpool Street to Yarmouth over Up Main/'C' line under single line working.</u> <u>07 00 to 16 00 Sun</u> <u>Single line working over 'C' line/Up Main line. (See Section 'C').</u>

SUNDAY 10 TO FRIDAY 15 AUGUST

183	Norwich and Whitlingham Jn	'A' and 'E' lines/Down and Up Lowestoft/Main BLOCKED) 23 30 Sun to Thu to 05 00 Mon to Fri.) Construction work (overhead line).) Crane and mechanical equipment in use. <u>Possession to be given up for passage of trains.</u>
	Norwich Station	Platforms 4, 5 and 6 BLOCKED)))

WEDNESDAY 13 AUGUST

184	Thorpe Jn and Brundall Jn	Down and Up	08 00 to 15 00. Unloading materials.
-----	---------------------------	-------------	--------------------------------------

WHITLINGHAM JN TO CROMER

UNTIL FURTHER NOTICE

185	Whitlingham Jn and Wroxham	Down and Up	07 30 to 16 30. Bridgework (No. 365). 3m. 48chs. (86/6)
-----	----------------------------	-------------	---

SECTION B - TEMPORARY ENGINEERING WORKS - continued

At or between	Lines affected	Remarks
---------------	----------------	---------

WHITLINGHAM JN TO CROMER - continued

UNTIL FURTHER NOTICE - continued

186	Cromer Station Platforms 1 and 2	Platform work. (86/15)
-----	----------------------------------	---------------------------

TUESDAY 12 AUGUST

187	Whitlingham Jn and Wroxham	Down and Up 08 00 to 15 00. Unloading materials.
-----	----------------------------	---

CROMER TO SHERINGHAM

UNTIL FURTHER NOTICE

188	Cromer Station Platforms 1 and 2	Platform work. (86/15)
-----	----------------------------------	---------------------------

BRUNDALL JN TO YARMOUTH VIA ACLE

UNTIL FURTHER NOTICE

189	Lingwood	Single 08 00 to 17 00. Construction work. 8m. 03chs. (86/12)
-----	----------	---

190	Acle Station	Down and Up 08 00 to 17 00. Platform work. <u>From 08 00 Monday 11 August.</u> (86/20)
-----	--------------	---

BETHNAL GREEN JN TO KING'S LYNN

UNTIL FURTHER NOTICE

191	London Fields and Hackney Downs	Down and Up Suburban 07 30 to 18 00. Earthwork and construction work. Mechanical equipment in use. (85/27)
-----	---------------------------------	---

192	Hackney Downs	All 08 00 to 17 00. Signalling work. (86/1)
-----	---------------	---

193	Tottenham South Jn and Tottenham Hale	Down and Up Earthwork. Mechanical equipment in use. (85/54)
-----	---------------------------------------	---

SECTION B - TEMPORARY ENGINEERING WORKS - continued

At or between	Lines affected	Remarks
BETHNAL GREEN JN TO KING'S LYNN - continued		
UNTIL FURTHER NOTICE - continued		
194	Enfield Lock and Waltham Cross	Down and Up 07 00 to 18 00. Bridgework (No.1418C). 12m. 34chs. Crane and mechanical equipment in use. (85/59)
195	Bishops Stortford (Country end) and Stansted	Down and Up Main BLOCKED to electric trains Overhead line work. <u>Isolation of electrical sections 427, 428 (buffer section).</u> (85/41)
196	Bishops Stortford and Cambridge (North)	All 07 00 to 18 00. Construction work (overhead line). Mechanical equipment in use. (85/21)
197	Stansted	Down and Up Construction work. 33m. 29chs. (85/61)
198	Elsenham	Down and Up Construction work. 35m. 44chs. (85/61)
199	Newport	Down and Up 08 00 to 16 00. Platform work 39m. 74chs. Mechanical equipment in use. (85/37)
200	Shelford	Down and Up Platform work. 52m. 36chs. Mechanical equipment in use. (86/6)

SATURDAY/SUNDAY 9/10 AUGUST

201	Bishops Stortford and Elsenham	Up Main BLOCKED Down Main BLOCKED	23 45 to 08 20) Construction work (overhead line) 30% and 23 45 to 09 30) 35% m.p. <u>1P04 02 10</u>) <u>Liverpool Street to</u>) <u>Yarmouth and 1H02 03 10</u>) <u>Liverpool Street to</u>) <u>King's Lynn diverted</u>) <u>via Finsbury Park and</u>) <u>Hitchin.</u>
-----	--------------------------------	--	---

SECTION B - TEMPORARY ENGINEERING WORKS - continued

At or between	Lines affected	Remarks
---------------	----------------	---------

BETHNAL GREEN JN TO KING'S LYNN - continued

SATURDAY/SUNDAY 9/10 AUGUST - continued

202	Audley End and Great Chesterford	Up BLOCKED Down BLOCKED	22 15 to 08 15) 23 50 to 10 00)	Construction work (overhead line). 4½ and 45¾m.p. Mechanical equipment in use. <u>1P04 02 10</u> <u>Liverpool Street to</u> <u>Yarmouth and 1H02 03 10</u> <u>Liverpool Street to</u> <u>King's Lynn diverted</u> <u>via Finsbury Park and</u> <u>Hitchin.</u>
203	Shepreth Branch Jn	All <u>Between Trains</u>	21 00 to 09 00.	Track maintenance and signalling work. 53 and 53¾m.p. Mechanical equipment in use.

SATURDAY/SUNDAY 9/10 AND SUNDAY 10 AUGUST

204	Great Chesterford and Whittlesford Crossovers	Up Main BLOCKED Down Main BLOCKED	22 05 Sat to 08 15) 00 05 to 10 00 Sun)	Construction work (overhead line). 45¾ and 49¾m.p. Mechanical equipment in use. <u>1P04 02 10</u> <u>Liverpool Street to</u> <u>Yarmouth and 1H02</u> <u>03 10 Liverpool</u> <u>Street to King's</u> <u>Lynn diverted via</u> <u>Finsbury Park and</u> <u>Hitchin.</u>
-----	---	--	--	--

SECTION B - TEMPORARY ENGINEERING WORKS - continued

<u>At or between</u>	<u>Lines affected</u>	<u>Remarks</u>
<u>BETHNAL GREEN JN TO KING'S LYNN - continued</u>		
<u>SATURDAY/SUNDAY 9/10 AND SUNDAY 10 AUGUST - continued</u>		
205 Shepreth Branch Jn and Cambridge Station	Down Main/ Platform Line, Through Line/ Up Main and Down Goods BLOCKED	21 00 Sat to 10 30)Track renewal. 55%)and 55 $\frac{1}{2}$ m.p. Crane)and mechanical)equipment in use.) <u>21 00 Sat to 10 30</u>) <u>Possession to be</u>) <u>given up for</u>
Cambridge Station	Platform Line, Through line and Down Goods BLOCKED	10 30 to 21 00 Sun) <u>passage of 1P04</u>) <u>02 10 Liverpool</u>) <u>Street to Yarmouth</u>) <u>and 1H02 03 10</u>) <u>Liverpool Street to</u>) <u>King's Lynn over Up</u>) <u>Main line under</u>) <u>single line working</u>) <u>between Shepreth</u>) <u>Branch Jn and</u>) <u>Cambridge, then to</u>) <u>travel over No. 1</u>) <u>Reception line</u>) <u>(Cambridge Yard).</u>) <u>10 30 to 21 00 Sun</u>) <u>Trains to/from</u>) <u>Royston to travel</u>) <u>over Down Goods</u>) <u>Loop South/Down</u>) <u>Siding to/from</u>) <u>Platform 2. Other</u>) <u>Down trains to</u>) <u>travel over No. 1</u>) <u>Reception line</u>) <u>(Cambridge Yard).</u>) <u>Other Up trains to</u>) <u>travel over Up</u>) <u>Goods line.</u>) <u>Platforms 4, 5 and</u>) <u>6 NOT affected.</u>) <u>(See Section 'D').</u>

Passenger trains are authorised to travel over the Down Siding at a speed not exceeding 20 mph, over No. 1 Reception line at a speed not exceeding 15 mph and over the Up Goods line.

SECTION B - TEMPORARY ENGINEERING WORKS - continued

<u>At or between</u>	<u>Lines affected</u>	<u>Remarks</u>
<u>BETHNAL GREEN JN TO KING'S LYNN - continued</u>		
SATURDAY/SUNDAY 9/10 AND SUNDAY 10 AUGUST - continued		
206 Chesterton Jn and Waterbeach	Down BLOCKED Up BLOCKED	22 30 Sat to 08 00)Earthwork. 58% and 00 05 to 08 00 Sun)59m.p. Mechanical equipment in use.) <u>Possession to be given up for passage of 1P04 02 10 Liverpool Street to Yarmouth and 1H02 03 10 Liverpool Street to King's Lynn over Down line.</u>

SATURDAY 9 AND SUNDAY 10 AUGUST

207 Newport	Down <u>Between Trains</u>	08 00 to 16 00 daily. Platform work 39m. 74chs. Mechanical equipment in use.
-------------	-------------------------------	--

SUNDAY 10 AUGUST

208 Clapton Jn and Cheshunt Jn	Down and Up Main BLOCKED to electric trains	00 01 to 22 00. In connection with engineering work between Tottenham South Jn and Cheshunt Jn. <u>Isolation of electrical sections 411 and 412. Electric trains diverted via Southbury.</u>
209 Tottenham South Jn and Cheshunt Jn	Down and Up Main BLOCKED	00 01 to 22 00. Track renewal, construction work, repairs to Brimsdown signalbox, drainage and overhead line work. Mechanical equipment in use. <u>1P04 02 10 Liverpool Street to Yarmouth and 1H02 03 10 Liverpool Street to King's Lynn diverted via Finsbury Park and Hitchin. Other trains diverted via Southbury.</u>
210 Broxbourne Jn and Bishops Stortford	All BLOCKED to electric trains	00 35 to 08 30. In connection with engineering work between Broxbourne Jn and Harlow Town. <u>Isolation of electrical sections 415, 416, 417 and 418.</u>

SECTION B - TEMPORARY ENGINEERING WORKS - continued

At or between	Lines affected	Remarks
<u>BETHNAL GREEN JN TO KING'S LYNN - continued</u>		
SUNDAY 10 AUGUST - continued		
211 Broxbourne Jn and Harlow Town	Down BLOCKED Up BLOCKED	00 15 to 09 00)Track renewal,)bridgework (No. 1436) 00 15 to 16 00)and overhead line work.)Crane and mechanical)equipment in use.) <u>00 15 to 09 00. 1P04</u>) <u>02 10 Liverpool Street</u>) <u>to Yarmouth and 1H02</u>) <u>03 10 Liverpool Street</u>) <u>to King's Lynn diverted</u>) <u>via Finsbury Park and</u>) <u>Hitchin. 08 30 to</u>) <u>16 00 Isolation of</u>) <u>electrical sections</u>) <u>415E. 09 00 to 16 00</u>) <u>Single line working</u>) <u>over Down line.</u>

212 Bishops Stortford	All BLOCKED	00 30 to 08 30. Track renewal (No. 109 points). <u>1P04 02 10 Liverpool Street to Yarmouth and 1H02 03 10 Liverpool Street to King's Lynn diverted via Finsbury Park and Hitchin.</u>
213 Cambridge and Coldham Lane Jn	Down and Up Main BLOCKED	00 30 to 07 30. Construction work (overhead line). 55% and 56% m.p. Mechanical equipment in use. <u>Possession to be given up for passage of 1P04 02 10 Liverpool Street to Yarmouth and 1H02 03 10 Liverpool Street to King's Lynn over Down Main line.</u>
214 Ely Station North and Ely North Jn	Down and Up BLOCKED	00 01 to 08 00. Track maintenance 71m. 65chs. <u>Possession to be given up for passage of 1P04 02 10 Liverpool Street to Yarmouth and 1H02 03 10 Liverpool Street to King's Lynn over Down Line.</u>

MONDAY 11 AUGUST

215 Clapton Jn and Broxbourne Jn	All BLOCKED to electric trains	01 00 to 03 55. In connection with overhead line work between Brimsdown and Cheshunt Station. <u>Isolation of electrical sections 411, 412, 413 and 414.</u>
----------------------------------	--------------------------------------	--

SECTION B - TEMPORARY ENGINEERING WORKS - continued

At or between	Lines affected	Remarks
<u>BETHNAL GREEN JN TO KING'S LYNN - continued</u>		
MONDAY 11 AUGUST - continued		
216 Brimsdown and Cheshunt Station	Down and Up Main BLOCKED	01 00 to 03 55. Overhead line work. <u>Possession given up for passage of Diesel trains.</u>
MONDAY/TUESDAY 11/12 AUGUST		
217 Whittlesford Crossovers and Audley End	Up Main BLOCKED	22 35 to 04 55. Track maintenance and signalling work. 45% and 45% m.p. Mechanical equipment in use. <u>Single line working over Down Main line.</u>
MONDAY 11 TO FRIDAY 15 AUGUST		
218 Bethnal Green and Hackney Downs	Down Fast BLOCKED	10 15 to 15 00 daily. Construction work (London Fields Station). <u>Isolation of electrical sections 316. Down Trains to travel over Down Suburban line.</u>
219 Cambridge (South) and Coldham Lane Jn	All <u>Between Trains</u>	08 00 to 18 00 daily. Construction work (overhead line). 55% and 56% m.p. Mechanical equipment in use.
TUESDAY 12 AND WEDNESDAY 13 AUGUST		
220 Brimsdown and Cheshunt Station	Down Main BLOCKED	00 01 to 05 45 daily. Track maintenance. Mechanical equipment in use. <u>Single line working over Up Main line.</u>
WEDNESDAY 13 AUGUST		
221 Ely Dock Jn and Waterbeach	Up BLOCKED	00 35 to 05 20. Track maintenance 69 and 61 m.p. Mechanical equipment in use. <u>Single line working over Down line.</u>

SECTION B - TEMPORARY ENGINEERING WORKS - continued

At or between	Lines affected	Remarks
---------------	----------------	---------

BETHNAL GREEN JN TO KING'S LYNN - continued

WEDNESDAY 13 AND THURSDAY 14 AUGUST

222 Cambridge	Platform line and Through line BLOCKED	01 30 to 05 30 daily. Track maintenance 55% and 55 $\frac{1}{2}$ m.p. Mechanical equipment in use. <u>Trains to travel over other lines. Access available to/from Platform 2.</u>
---------------	---	---

WEDNESDAY 13 TO FRIDAY 15 AUGUST

223 Harlow Town and Broxbourne Jn.	Up BLOCKED	23 05 Wed and Thu to 04 30 Thu and Fri. Track maintenance. Mechanical equipment in use. <u>Single line working over Down line.</u>
------------------------------------	---------------	--

THURSDAY/FRIDAY 14/15 AUGUST

224 Coldham Lane Jn. and Waterbeach	Down BLOCKED	22 20 to 04 30. Track maintenance 56% and 61m.p. Mechanical equipment in use. <u>Single line working over Up line.</u>
-------------------------------------	-----------------	--

CLAPTON JN TO CHINGFORD

SATURDAY 9 AUGUST

225 Clapton Jn. and Chingford	Down and Up BLOCKED	00 55 to 04 30. Overhead line work. Mechanical equipment in use. <u>Isolation of electrical sections 409 and 410.</u>
-------------------------------	------------------------	---

SUNDAY 10 AUGUST

226 Clapton Jn. and Chingford	Down and Up BLOCKED	01 00 to 06 30. Track maintenance 5m. 50chs. and 5m. 70chs.
-------------------------------	------------------------	---

WEDNESDAY 13 TO FRIDAY 15 AUGUST

227 Clapton Jn and Chingford	Down and Up BLOCKED	00 55 to 04 30 daily. Overhead line work. Mechanical equipment in use. <u>Isolation of electrical sections 409 and 410.</u>
------------------------------	------------------------	---

SECTION B - TEMPORARY ENGINEERING WORKS - continued

At or between	Lines affected	Remarks
---------------	----------------	---------

BROXBOURNE JN TO HERTFORD EAST

UNTIL FURTHER NOTICE

228 Rye House and St. Margarets	Down and Up	08 00 to 18 00. Bridgework (No. 2035A). 19m. 66chs. Mechanical equipment in use. (85/60)
---------------------------------	-------------	---

SUNDAY 10 AUGUST

229 Broxbourne Jn and Hertford East	All BLOCKED	00 30 to 06 30. Bridgework (No. 2035A) 19m 66chs. Mechanical equipment in use. <u>Isolation of electrical sections 434 and 435.</u>
-------------------------------------	----------------	---

MONDAY 11 AUGUST

230 Broxbourne Jn and St. Margarets	Down and Up BLOCKED to electric trains	01 00 to 03 55. In connection with overhead line work between Brimsdown and Cheshunt Station. <u>Isolation of electrical sections 414.</u>
-------------------------------------	--	--

COLDHAM LANE JN TO HAUGHLEY JN

UNTIL FURTHER NOTICE

231 Bury St. Edmunds Station	Down	08 00 to 15 00. Repairs to platform awnings. (86/18)
232 Bury St. Edmunds and Elmswell	Down and Up	08 00 to 18 00. Drainage 29m. 78chs. Mechanical equipment in use. (86/12)

SATURDAY/SUNDAY 9/10 AUGUST

233 Bury St. Edmunds and Haughley Jn	Up BLOCKED Down BLOCKED	22 00 to 08 00) Drainage and track) maintenance. 23 15 to 08 00) Mechanical equipment) in use.
--------------------------------------	----------------------------------	---

SECTION B - TEMPORARY ENGINEERING WORKS - continued

At or between	Lines affected	Remarks
---------------	----------------	---------

CHIPPENHAM JN TO ELY DOCK JN

UNTIL FURTHER NOTICE

234	Soham and Chippenham Jn	Up <u>Between Trains</u>	07 00 to 19 00. Earthwork. 3m.p. Mechanical equipment in use. (86/17)
-----	----------------------------	-----------------------------	---

ELY NORTH JN. TO ELY WEST JN. (ELY WEST CURVE)

SUNDAY 10 AUGUST

235	Ely North Jn. and Ely West Jn.	Down and Up BLOCKED	00 01 to 08 00. Track maintenance. 71m 65chs.
-----	--------------------------------------	------------------------	--

TUESDAY/WEDNESDAY 12/13 AUGUST

236	Ely West Jn. and Ely North Jn.	Up BLOCKED	23 00 to 05 00. Track maintenance 72 $\frac{1}{2}$ and 71 $\frac{1}{2}$ m.p. Mechanical equipment in use.
-----	--------------------------------------	---------------	---

THURSDAY 14 AUGUST

237	Ely North Jn. and Ely West Jn.	Down BLOCKED	00 01 to 06 00. Track maintenance 71 $\frac{1}{2}$ and 72 $\frac{1}{2}$ m.p. Mechanical equipment in use.
-----	--------------------------------------	-----------------	---

ELY NORTH JN TO PETERBOROUGH, CRESCENT JN

SATURDAY/SUNDAY 9/10 AUGUST

238	Ely North Jn. and Manea	Down BLOCKED Up BLOCKED	22 50 to 08 00)Track maintenance. 72)and 80m.p. Mechanical 23 45 to 08 00)equipment in use.)
239	Manea and March South Jn	Down BLOCKED Up BLOCKED	22 50 to 08 30)Track renewal and track)maintenance. 81 $\frac{1}{2}$ and 23 30 to 15 30)81 $\frac{1}{2}$ m.p. <u>08 30 to 15 30</u>) <u>Sun Single line working</u>) <u>over Down line.</u>
240	March East Jn. and Crescent Jn.	Down and Up Main BLOCKED	23 30 to 08 00. Track maintenance. 89 and 100 $\frac{1}{2}$ m.p. Mechanical equipment in use.

SECTION B - TEMPORARY ENGINEERING WORKS - continued

<u>At or between</u>	<u>Lines affected</u>	<u>Remarks</u>
----------------------	-----------------------	----------------

ELY NORTH JN TO PETERBOROUGH, CRESCENT JN - continued

THURSDAY 14 AUGUST

241	March South Jn and Manea	Up BLOCKED	00 01 to 05 00. Track maintenance 81% and 81% m.p. Mechanical equipment in use. <u>Single line working over Down line.</u>
-----	--------------------------	---------------	--

ELY NORTH JN TO TROWSE LOWER JN

UNTIL FURTHER NOTICE

242	Wymondham and Hethersett	Down and Up <u>Between Trains</u>	07 30 to 18 00. Bridgework, earthwork and construction work. 115m. 65chs. and 117m. 69chs. Cranes and mechanical equipment in use. (86/18)
243	Wymondham and Trowse Lower Jn	Down and Up	07 30 to 16 00. Signalling work. (85/24)
244	Hethersett and Trowse Lower Jn	Down and Up	08 00 to 16 00. Bridgework (Nos. 1638 and 349). 121m. 17chs. and 122m. 32chs. (85/62)

SATURDAY/SUNDAY 9/10 AUGUST

245	Brandon and Thetford	Up BLOCKED Down BLOCKED	22 00 to 08 15) Track maintenance,) track renewal and 22 30 to 16 00) loading materials.) Mechanical equipment) in use. 22 00 Sat to) <u>08 15 Possession to</u>) <u>be given up for passage</u>) <u>of 1P04 02 10 Liverpool</u>) <u>Street to Yarmouth</u>) <u>over Up line under</u>) <u>single line working.</u>) <u>08 15 to 16 00 Sun</u>) <u>Single line working</u>) <u>over Up line.</u>
-----	----------------------	----------------------------------	---

SECTION B - TEMPORARY ENGINEERING WORKS - continued

At or between	Lines affected	Remarks
<u>ELY NORTH JN TO TROWSE LOWER JN - continued</u>		
SATURDAY/SUNDAY 9/10 AUGUST - continued		
246 Wymondham and Trowse Lower Jn	Up BLOCKED Down BLOCKED	22 00 to 07 30)Track maintenance and undertrack excavation. 23 00 to 07 30)Possession to be given up for passage of 1P04 02 10 Liverpool Street to Yarmouth over Down line.

MONDAY/TUESDAY 11/12 AUGUST

247 Ely North Jn. and Lakenheath	Down BLOCKED Up BLOCKED	23 00 Mon to 06 00)Track maintenance and signalling. 00 01 to 06 00 Tue)work. 72 and 81½m.p. Mechanical equipment in use.
----------------------------------	----------------------------------	---

MONDAY 11 TO FRIDAY 15 AUGUST

248 Brandon	All	08 00 to 16 00 daily. Track maintenance.
-------------	-----	--

WEDNESDAY 13 TO FRIDAY 15 AUGUST

249 Ely North Jn. and Lakenheath	Down BLOCKED Up BLOCKED	23 00 Wed and Thu to)Track maintenance 06 00 Thu and Fri)and signalling work. 72 and 00 10 to 06 00)81½m.p. Thu and Fri)Mechanical equipment in use.
----------------------------------	----------------------------------	---

THURSDAY/FRIDAY 14/15 AUGUST

250 Brandon and Thetford	Down and Up BLOCKED	23 45 to 06 00. Track maintenance. Mechanical equipment in use.
--------------------------	------------------------	--

WYMONDHAM TO NORTH ELMHAM

UNTIL FURTHER NOTICE

251 Wymondham and North Elmham	Single	08 00 to 16 00. Trimming lineside vegetation. ½ and 6m.p. Mechanical equipment in use.
--------------------------------	--------	--

SECTION B - TEMPORARY ENGINEERING WORKS - continued

<u>At or between</u>	<u>Lines affected</u>	<u>Remarks</u>
<u>FENCHURCH STREET TO SHOE BURYNNESS</u>		
UNTIL FURTHER NOTICE		
252 Fenchurch Street Station	All	Construction/demolition work. Mechanical equipment in use. (84/38)
253 Fenchurch Street and Christian Street Jn	Down and Up Slow	07 00 to 18 00. In connection with engineering work. (85/20)
254 Fenchurch Street and Stepney East	All	07 30 to 18 30. Construction work. Mechanical equipment in use. (85/27)
255 Fenchurch Street and Gas, Factory Jn	All	08 00 to 17 00. Signalling work. (86/1)
256 East Ham	Down and Up	Construction work. Mechanical equipment in use. (83/51)
257 East Ham and Barking (London End)	Down and Up	Erecting scaffolding in connection with bridge No. 66B. (85/8)
258 Leigh-on-Sea and Benfleet	Up	Sea wall work. (85/34)
259 Leigh-on-Sea	Down	09 00 to 16 00. Demolition work. Mechanical equipment in use. (85/60)
260 Westcliff-on-Sea	Down	09 00 to 16 00. Demolition work. Mechanical equipment in use. (85/60)
FRIDAY/SATURDAY 8/9 AUGUST		
261 Fenchurch Street	All BLOCKED	21 15 to 06 00. Construction work. Mechanical equipment in use.
262 Fenchurch Street and Gas Factory Jn	All	22 00 to 05 00. Signalling work.

SECTION B - TEMPORARY ENGINEERING WORKS - continued

At or between	Lines affected	Remarks
---------------	----------------	---------

FENCHURCH STREET TO SHOEBURYNNESS - continued

FRIDAY/SATURDAY 8/9 AUGUST - continued

263 East Ham (London End) and Barking Station (London End)	Down and Up Main BLOCKED	21 15 to 05 15. Bridgework (No. 66B). Crane and mechanical equipment in use. <u>Isolation of electrical sections 510A, 511E.</u>
--	-----------------------------	--

SATURDAY 9 AUGUST

264 Fenchurch Street Station	Platforms 1 and 2 BLOCKED	07 00 to 16 30. Construction work. Mechanical equipment in use. <u>Trains to be replatformed as necessary.</u>
---------------------------------	------------------------------	--

SUNDAY 10 AUGUST

265 East Ham (London End) and Barking Station (London End)	Down and Up Main BLOCKED	00 01 to 06 15. Bridgework (No. 66B). Crane and mechanical equipment in use. <u>Isolation of electrical sections 510A, 511E.</u>
--	-----------------------------	--

266 Barking	Down and Up Tilbury (Platforms 7 and 8) and Up Goods Loop BLOCKED	00 50 to 06 15. Overhead line work (conversion). <u>Isolation of electrical sections 512D, 513ABCD. Possession to be given up for passage of Engineers' trains.</u>
-------------	--	--

267 Upminster and Pitsea	Down and Up BLOCKED	01 15 to 22 00. Overhead line work, track maintenance, painting Basildon Station and track renewal. Crane and mechanical equipment in use. <u>Isolation of electrical sections 517, 518, 519 and 520. Trains diverted via Grays. (See Section 'C').</u>
-----------------------------	------------------------	---

MONDAY 11 TO FRIDAY 15 AUGUST

268 Fenchurch Street and East Ham (London End)	All BLOCKED	21 15 Mon to Thu to 06 00 Tue to Fri. Loading and unloading rails and materials. Crane in use. <u>Isolation of electrical sections 507 and 508.</u>
---	----------------	---

SECTION B - TEMPORARY ENGINEERING WORKS - continued

<u>At or between</u>	<u>Lines affected</u>	<u>Remarks</u>
<u>FENCHURCH STREET TO SHOEBURYNNESS - continued</u>		
MONDAY 11 TO SATURDAY 16 AUGUST		
269 Fenchurch Street	All BLOCKED	21 15 Mon to Fri to 06 00 Tue to Sat. Construction work. Mechanical equipment in use.
270 East Ham (London End) and Barking Station (London End)	Down and Up Main BLOCKED	21 15 Mon to Fri to 05 15 Tue to Sat. Bridgework (No. 66B). Crane and mechanical equipment in use. <u>Isolation of electrical sections 510A, 511E.</u>
TUESDAY 12 AUGUST		
271 Leigh-on-Sea and Southend Central	Down and Up	11 00 to 14 30. Unloading materials.
TUESDAY 12 TO FRIDAY 15 AUGUST		
272 Upminster and Pitsea	Down and Up BLOCKED	01 15 to 04 25 daily. Track maintenance. Mechanical equipment in use. <u>Trains diverted via Grays.</u>
<u>UPPER HOLLOWAY TO BARKING, TILBURY LINE JN WEST</u>		
UNTIL FURTHER NOTICE		
273 Upper Holloway and Crouch Hill Station	Down and Up	Earthwork. 3m. 4lchs. and 3m. 43chs. Mechanical equipment in use. (85/64)
274 Wanstead Park Station	Up	08 00 to 16 00. Platform work. <u>(See Section 'D')</u> . (85/50)
275 Woodgrange Park and Barking Station Jn	Down and Up <u>Between Trains</u>	07 30 to 18 00. Bridgework (No. 6). 12m. 26chs. Crane and mechanical equipment in use. (85/62)
276 Woodgrange Park and Barking Tilbury Line Jn West	Down and Up	Erecting scaffolding in connection with bridge No. 14A. (85/8)

SECTION B - TEMPORARY ENGINEERING WORKS - continued

At or between	Lines affected	Remarks
---------------	----------------	---------

UPPER HOLLOWAY TO BARKING, TILBURY LINE JN WEST - continued

SUNDAY 10 AUGUST

277	South Tottenham East Jn. and Woodgrange Park Jn.	Down and Up BLOCKED	00 01 to 07 45. Bridgework (No.369).
278	Forest Gate Jn and Barking Tilbury Line Jn West	Down and Up BLOCKED to electric trains	00 50 to 18 00. In connection with engineering work. <u>Isolation of electrical sections 512AB, 513EF.</u>
279	Woodgrange Park Jn and Barking Tilbury Line Jn West	Down and Up BLOCKED	00 50 to 06 15. Bridgework (Nos. 6 and 14A). Crane and mechanical equipment in use. <u>Possession to be given up for passage of Engineers' trains.</u>
280	Barking Station Jn. and Woodgrange Park Station	Up BLOCKED	08 00 to 18 00. Overhead line work (conversion). <u>Single line working over Down line.</u>

BARKING, TILBURY LINE JN EAST TO TILBURY RIVERSIDE

UNTIL FURTHER NOTICE

281	Dagenham Dock Station	Down and Up	08 00 to 17 00. Construction work. Mechanical equipment in use. (85/14)
282	Rainham Station	Down and Up	08 00 to 17 00. Construction work. Mechanical equipment in use. (85/14)
283	Purfleet Station	Down and Up	09 00 to 16 00. Platform work. Mechanical equipment in use. (85/61)
284	Purfleet and West Thurrock Jn	Down and Up	07 30 to 18 00. Bridgework (No. 94A), 17m. 34chs. Mechanical equipment in use. (85/21)

SECTION B - TEMPORARY ENGINEERING WORKS - continued

At or between	Lines affected	Remarks
---------------	----------------	---------

BARKING, TILBURY LINE JN EAST TO TILBURY RIVERSIDE - continued

SUNDAY 10 AUGUST

285	Barking Tilbury Line Jn East and West Thurrock Jn	Down and Up Main BLOCKED	00 35 to 07 00. Track maintenance. 8½ and 14¾m.p.
286	West Thurrock Jn and Tilbury East Jn.	Down and Up BLOCKED	00 40 to 06 10. Track maintenance. Mechanical equipment in use.

MONDAY 11 AUGUST

287	Rainham and Thames Haven Jn	All BLOCKED to electric trains	01 15 to 04 15. In connection with overhead line work between Grays and Tilbury Town. <u>Isolation of electrical sections 532, 533, 534 and 535.</u>
288	Grays and Tilbury Town	Down and Up BLOCKED	01 15 to 04 15. Overhead line work. <u>Possession to be given up for passage of Diesel trains.</u>

TILBURY WEST JN. TO TILBURY EAST JN.

MONDAY 11 AUGUST

289	Rainham and Thames Haven Jn	All BLOCKED to electric trains	01 15 to 04 15. In connection with overhead line work between Grays and Tilbury Town. <u>Isolation of electrical sections 532, 533, 534 and 535.</u>
-----	-----------------------------	-----------------------------------	--

TILBURY RIVERSIDE TO PITSEA

MONDAY 11 AUGUST

290	Rainham and Thames Haven Jn	All BLOCKED to electric trains	01 15 to 04 15. In connection with overhead line work between Grays and Tilbury Town. <u>Isolation of electrical sections 532, 533, 534 and 535.</u>
-----	-----------------------------	-----------------------------------	--

UPMINSTER TO WEST THURROCK JN

WEDNESDAY 13 AUGUST

291	Upminster and West Thurrock Jn	Single BLOCKED	09 40 to 15 15. Loading and unloading materials.
-----	--------------------------------	-------------------	--

SECTION CSIGNALLING AND PERMANENT WAY ALTERATIONS

- * * Items marked thus will not appear in future issues and a note must be
* taken of them by all concerned.

DETAILS OF WORK REFERRED TO IN SECTION BSUNDAY 10 AUGUST - BETWEEN TROWSE SWING BRIDGE AND THORPE JUNCTION

The Down Main will be realigned between Trowse Swing Bridge and Thorpe Junction. (The new alignment will be towards and partly on the alignment of the former Goods Yard Siding/Down Goods line recently removed).

Access to the realigned Down Main at the Trowse Swing Bridge end will be via the former Down Main to Goods Yard Siding/Down Goods line facing connection, which will be restored to use.

Trowse Swing Bridge Down Main semaphore Starting Signal will apply applicable towards NO 565 signal via the realigned Down Main.

The ground shunting signal, applying set back on the realigned Down Main, at Trowse Swing Bridge will be restored to use and will apply towards the Up Main.

Reference should be made to the diagram included in Supplementary Signalling Notice No. 144 (Page 4) dated Sunday 3 August.

(23)

MONDAY 11 AUGUST - SOUTHMINSTER

A 15 m.p.h. Permanent Speed Restriction applicable to Down and Up trains will be IMPOSED on the SINGLE line in the vicinity of Southminster station between 45m. 23chs. and 45m. 42chs. (end of line). (See Section 'D').

(23)

TUESDAY 12 AUGUST - WOODBRIDGE

The Up direction flashing White Light/Point Indication Light adjacent to Sun Wharf/Lime Kiln level crossings will be repositioned closer to the Single line at a distance of 5 yards from Sun Wharf Level Crossing.

(23)

DETAILS OF WORK ALREADY CARRIED OUTGIDEA PARK

The Engine Shunt Spur at the London end of the Down Siding, has been taken out of use until further notice.

(22)

SECTION C - SIGNALLING AND PERMANENT WAY ALTERATIONS - continuedDETAILS OF WORK ALREADY CARRIED OUT - continuedNEW HALL

The Up Loop has been taken out of use Until Further Notice.

(UFN)

HATFIELD PEVEREL

The facing and trailing crossovers are out of use until further notice.

(UFN)

AUDLEY END LEVEL CROSSING AT 97m 05chs (FORMERLY KNOWN AS ARDLEY END LEVEL CROSSING) - BETWEEN DISS AND TIVETSHALL

The crossing has been converted to an Automatic Half-barrier level crossing. Telephone communication has been provided between the crossing and Diss signalbox.

The barriers are equipped to work automatically when approached in the wrong direction, and for this purpose, a combined St. Andrew's Cross/50 m.p.h. speed restriction sign has been provided applicable to each rail approach in the wrong direction as follows :-

1,089 yards south of the crossing on the Up Main, applicable to the Down (wrong) direction of approach.

974 yards north of Audley End crossing on the Down Main, applicable to the Up (wrong) direction of approach.

Burston Automatic Half-barrier Level Crossing at 97m 42chs

The St. Andrew's Cross/50 m.p.h. speed restriction sign applicable to Burston level crossing, located on the Up Main, approximately 130 yards south of Audley End level crossing has been repositioned to a location immediately north of Audley End level crossing. (This sign is applicable to wrong (Down) direction trains approaching Burston level crossing on the Up Main).

(22)

TROWSE YARD SIGNALBOX

The Down Siding, (adjacent to the Down Main) and the S & T Loading Dock Siding have been taken out of use.

Connections to these Sidings have been secured for through running to/from the Back Road (Loading Dock) Siding.

All associated signals/signal routes have been abolished.

(22)

SECTION C - SIGNALLING AND PERMANENT WAY ALTERATIONS - continuedDETAILS OF WORK ALREADY CARRIED OUT - continuedNORWICH STATION AND THORPE JUNCTION (BETWEEN TROWSE SWING BRIDGE AND NORWICH AND BETWEEN THORPE JUNCTION AND WHITLINGHAM JUNCTION)

Reference should be made to Supplementary Signalling Notice No. 144. All concerned should be in possession of a copy of this notice. (22)

CAMBRIDGE UP YARD

Sidings Nos. 1 to 11 inc. have been shortened by 80 yards. (23)
(New Item)

* * LAINDON
*

The sand-drag at the London end of the station has been removed and the associated points secured so as to provide through running between the Down and Up Main lines and the Reversing line. (20)

TILBURY FREIGHTLINER DEPOT

The hand spring-points in Seabrook Sidings are now detected in the normal position and a Points Indicator situated adjacent to the points displays YELLOW when the points are normal.

The Acceptance Plunger (from Grays Signal Box direction) has been resited in the Shunters Cabin.

(The telephone adjacent to the spring points remains in its former position). (21)

SECTION D

GENERAL INSTRUCTIONS AND NOTICES

A thick vertical line denotes new or amended items.

- ** Items marked thus will not appear in future issues and a note must be
- * taken of them by all concerned.

ALTERATION TO WORKING MANUAL FOR RAIL STAFF (B.R. 30054)

PART 2 : GREEN PAGES

C. OVERHANGING LOADS

1. Bolster and Other Wagons

Clause C1/6(a) should read :-

Runner Wagons must have a tare weight of not less than 10.5 tonnes.

(UFN)

EASTERN REGION SECTIONAL APPENDIX (SOUTHERN AREA)

TABLE A : DETAILS OF RUNNING LINES

Running Lines and Signalling System	Location	M. Ch.	Permanent Speed Restrictions		Remarks
			Down m.p.h.	Up m.p.h.	
<u>LIVERPOOL STREET TO NORWICH</u>					
<u>Page 60</u>					
<u>Delete:-</u>	Ardley End LC	97 00			
<u>Substitute :-</u>	Audley End (Norfolk) LC (AHB-X)	97 05	X50	X50	<u>Approaching level crossing in wrong direction.</u>
					(10.SD)
<u>WICKFORD JN. TO SOUTHMINSTER</u>					
<u>Page 68 (Page 20, SD.PON)</u>					
At Southminster					
<u>Add:-</u>			15	15	<u>45m. 23chs. and 45m. 42chs.</u>
					<u>(w.e.f. Monday 11 August)</u> (10.SD)

SECTION D - GENERAL INSTRUCTIONS AND NOTICES - continued

EASTERN REGION SECTIONAL APPENDIX (SOUTHERN AREA) - continued

Running Lines and Signalling System	Location	M. Ch.	Permanent Speed Restrictions		Remarks
			Down m.p.h.	Up m.p.h.	
<p><u>NORWICH TO LOWESTOFT</u></p> <p><u>Page 78 (Page A44, SD PON)</u></p> <p>Delete all details between Norwich Thorpe Jn and Whitlingham Jn and <u>substitute :-</u></p>					
<p>Line W Line C Line E Line B Line A</p>	Norwich	0 00	<u>15</u>	<u>All lines. 0m.p. and 0m. 38chs.</u>	
	Norwich (NO)	0 23			Norwich (NO) signal box area between Norwich and Crown Point.
	Thorpe Jn (See page 61)	0 29			

SECTION D - GENERAL INSTRUCTIONS AND NOTICES - continued

EASTERN REGION SECTIONAL APPENDIX (SOUTHERN AREA) - continued

Running Lines and Signalling System	Location	M. Ch.	Permanent Speed Restrictions		Remarks
			Down m.p.h.	Up m.p.h.	
<p><u>NORWICH TO LOWESTOFT - continued</u></p> <p><u>Page 78 (Page A44, SD PON) - continued</u></p> <p><u>Delete all details between Norwich Thorpe Jn and Whitlingham Jn and substitute - continued :-</u></p>					
		0 35			
	Crown Point	0 60		15	All lines. Om. 38chs. and Om.p.
	Whitlingham Jn (WH) (See page 79)	1 69	25		To Cromer line.

SE-52

SECTION D - GENERAL INSTRUCTIONS AND NOTICES - continuedMISCELLANEOUS NOTICESSUNDAY 10 AUGUST - CAMBRIDGE STATION - WORKING OF TRAINS TO AND FROM THE STATION DURING ENGINEERING WORKWorking of Royston - Cambridge trains

Trains to Cambridge will be routed to platform 2 via the Down Goods Loop South and Down Siding line.

Trains departing platform 2 will be signalled to the L.O.S. board on Down Goods Loop South line then to No. 1 Reception line and thence to the Up Main line.

Working of Down Main line trains to Cambridge

These trains will be routed via No. 1 Reception line to the Down Goods Loop North line and thence to the station.

Working of Up Main line trains from Cambridge

These trains will be routed to the Down Goods Loop North and thence via the Up Goods line to the Up Main line.

General

The clearing of a position light signal to depart to the Up Main or Up Goods line will be authority to proceed towards the next controlled signal. Rule Book Section C Clause 5.1 is modified accordingly.

(20)

G.E. ELECTRIFIED LINES
RESIDUAL VOLTAGE TESTING ON OVERHEAD LINE EQUIPMENT

Commencing Sunday 10 August 1986 until Saturday 23 August 1986, from 23 00 hrs. - 06 00 hrs. (Sat. night/Sun. 16/17 August excluded), R.M. & E.E. Department test section are to conduct investigations to measure the voltage magnitude present on the overhead line equipment during a series of simulated emergency isolations.

The tests will embrace all electrified lines; Fenchurch Street to Shoeburyness, Liverpool Street to Clacton/Walton, Shenfield to Southend, Liverpool Street to Bishops Stortford/Hertford East and branches.

Electrical sections between certain neutral sections will be de-energised for periods of 3-5 minutes duration in the area under test. Whilst it is desirable to attain test conditions without the presence of electrical rolling stock inside the test area, if this is unavoidable, power will be restored to each electrical section concerned upon the completion of voltage measurements for that section.

(22)

SECTION D - GENERAL INSTRUCTIONS AND NOTICES - continuedMISCELLANEOUS NOTICES - continuedWORKING OF CLASS 313 AND CLASS 416 ELECTRIC MULTIPLE UNIT
TRAINS BETWEEN DALSTON WESTERN JN AND STRATFORD MARKETClass 313 Electric Multiple Units

These units must only work between Navarino Road Jn and Stratford Market stabling sidings when either the Graham Road Curve route to Liverpool Street is not available, or when the pantographs have failed to rise. When operating between Dalston Kingsland and Stratford Market stabling sidings and return in the D.C. mode, Drivers must not advance the controller beyond Notch 2.

THESE UNITS MUST NOT RUN BEYOND STRATFORD MARKET TOWARDS NORTH WOOLWICH.

Class 416 Electric Multiple Units

Not more than two Class 416 units may be coupled together.

When two Class 416 units are running in multiple between Dalston Western Jn and Stratford Market, including the stabling sidings or return, Drivers must not advance the controller beyond Notch 2.

(UFN)

BETHNAL GREEN STATION

Until Further Notice, whilst demolition work is taking place, Drivers of 4-Car EMU trains must stop their trains at the temporary stop boards provided.

(UFN)

DALSTON (KINGSLAND) STATION

The Down and Up platforms have been temporarily shortened at the Stratford end by 25 yards and only accommodate two coaches. Drivers of Down trains booked to stop at this station must bring their train to a stand at signal DW14/16. Drivers of Up trains booked to stop at this station must bring their train to a stand at the temporary stop board which has been provided adjacent to the footbridge.

(LM) (UFN)

HARWICH PARKESTON QUAY STATION

Until Further Notice, reconstruction work on Platform 2 will create hazards for passengers, including sub-standard surfaces and larger than normal gaps between the platform and train.

Special warning notices are to be exhibited and best use made of on-train and station announcing facilities to warn the Public of the danger.

(UFN)

SECTION D - GENERAL INSTRUCTIONS AND NOTICES - continuedMISCELLANEOUS NOTICES - continuedSAWBRIDGEWORTH STATION

The stop board on the Up platform has been temporarily moved 9 yards towards the Country side of its former position.

(UFN)

WANSTEAD PARK STATION

Whilst platform repairs are taking place, Drivers of Up trains must stop their trains at the temporary stop boards provided.

(UFN)

REPAIRS IN MOTIVE POWER DEPOTS, CARRIAGE SHEDS, WAGON REPAIR SHEDS AND WAREHOUSES

In connection with work being carried out at the undermentioned places, scaffolding or projections may be provided or unusual excavations may be made in the ground:-

Location	Nature of Work	Duration	Commencing date
Liverpool Street, Locomotive Holding Sidings.	Earthwork.	Continuously. Until Further Notice.	-
Stratford T.M.D. All lines.	Repairs to Motive Power Depot. Cranes and mechanical equipment in use.	Continuously. Until Further Notice.	-
Ilford EMU Depot, Nos. 19 and 20 Roads.	Drainage.	08 00 to 17 00 daily. Until Further Notice.	-
Ilford EMU Depot, Carriage Washer Roads BLOCKED	Renewal of carriage washer plant. <u>Isolation of electrical sections 361R.</u>	Continuously. Until Further Notice.	-
Ilford EMU Depot, Nos. 6 to 16 inc. Sidings BLOCKED to electric trains	In connection with construction work. <u>Isolation of electrical sections 361GH.</u>	11 00 to 13 00 daily.	<u>From Monday 11 until Friday 15 August.</u>

SECTION D - GENERAL INSTRUCTIONS AND NOTICES - continuedMISCELLANEOUS NOTICES - continuedREPAIRS IN MOTIVE POWER DEPOTS, CARRIAGE SHEDS, WAGON REPAIR SHEDS AND WAREHOUSES - continued

In connection with work being carried out at the undermentioned places, scaffolding or projections may be provided or unusual excavations may be made in the ground:-

Location	Nature of Work	Duration	Commencing date
Norwich Crown Point T & R.S. M.D., All lines BLOCKED	Construction work (overhead line) and track maintenance. Mechanical equipment in use. <u>Possession to be given up for passage of trains.</u>	08 00 to 17 00 daily. Until further notice.	-
East Ham EMU Depot, All lines.	Shed reconstruction.	Continuously. Until Further Notice.	-
East Ham EMU Depot, Washer Road BLOCKED	Repairs to washer plant. <u>Isolation of electrical sections 509A.</u>	Continuously. Until Further Notice.	-
East Ham EMU Depot, Nos. 17, 18, 19 and 20 Sidings BLOCKED to electric trains	In connection with engineering work between East Ham and Barking. Crane and mechanical equipment in use. <u>Isolation of electrical sections 509J.</u>	21 15 Mon to Fri to 05 15 Tue to Sat.	<u>From Monday 4 until Saturday 9 August.</u>
East Ham EMU Depot, Nos. 17, 18, 19 and 20 Sidings BLOCKED to electric trains	In connection with engineering work between East Ham and Barking. Crane and mechanical equipment in use. <u>Isolation of electrical sections 509J.</u>	00 01 to 06 15 <u>Sunday 10 August.</u>	-

SECTION D - GENERAL INSTRUCTIONS AND NOTICES - continuedMISCELLANEOUS NOTICES - continuedREPAIRS IN MOTIVE POWER DEPOTS, CARRIAGE SHEDS, WAGON REPAIR SHEDS AND WAREHOUSES - continued

In connection with work being carried out at the undermentioned places, scaffolding or projections may be provided or unusual excavations may be made in the ground:-

Location	Nature of Work	Duration	Commencing date
East Ham EMU Depot, Nos. 17, 18, 19 and 20 Sidings BLOCKED to electric trains	In connection with engineering work between East Ham and Barking. Crane and mechanical equipment in use. <u>Isolation of electrical sections 509J.</u>	21 15 Mon to Fri to 05 15 Tue to Sat.	<u>From Monday 11 until Saturday 16 August.</u>

MP.32/SE
YORK
31 JULY, 1986

C. McKEEVER
Regional Operations Manager

Room 21

BRITISH RAIL
EASTERN REGION

SE

21

WEEKLY OPERATING NOTICE

CONTAINING

TEMPORARY SPEED RESTRICTIONS

TEMPORARY ENGINEERING WORKS

SIGNALLING AND
PERMANENT WAY ALTERATIONS

GENERAL INSTRUCTIONS AND NOTICES

SATURDAY 16 AUGUST

TO

FRIDAY 22 AUGUST 1986

INCLUSIVE

Trainmen must pay particular attention to works contained in this notice and keep a good look-out for handsignals which may be exhibited in accordance with the Rules and Regulations.

Work at places other than those mentioned may be in progress and Drivers must be on the look-out and be prepared to stop or run at reduced speed when, and where, handsignals may be exhibited.



WARNING



*
*
* ENERGISATION OF DOCKLANDS LIGHT RAILWAY BETWEEN BOW AND *
* STRATFORD STATION (ADJACENT TO THE B.R. UP ELECTRIC LINE) *
* *
* From 00 01 hours on Monday 18 August 1986, the conductor rails *
* between Bow Church, south of Bow Junction and Stratford Station *
* will be energised at 750 volts D.C. and must thereafter be regarded *
* as 'ALIVE' at all times. *
* (22) *
*

SECTION A

TEMPORARY SPEED RESTRICTIONS

(Until further notice unless otherwise specified)

Warning Boards and Indicators provided unless otherwise shown.

† Indicates that the Warning Boards and Indicators will be moved as the work progresses. Where two speeds are shown for a restriction e.g. $\frac{20}{40}$ the Rule

Book, Section U, Clause 1.2 applies.

Location	Lines affected	Mileage		Restr- iction m.p.h.	Remarks
		at or between M. Ch. M. Ch.			
<u>LIVERPOOL STREET TO NORWICH</u>					
<u>Warning board at Om. 63chs. (on the Down Main line) applies only to trains proceeding over the Down Electric line towards Stratford. Until 10 00 Tuesday 19 August.</u>					
1 Bethnal Green Station Jn and Bow Jn	Down Electric	-	1 25 1 27	20	Bridgework (No. 28). (86/14) <u>Until 10.00</u> <u>Tuesday 19</u> <u>August.</u>
2 Bow Jn and Bethnal Green Station Jn	-	Up Electric	1 27 1 25	30	Bridgework (No. 28). (86/14) <u>Until 10.00</u> <u>Tuesday 19</u> <u>August.</u>
3 Bow Jn and Stratford	Down Electric	Up Electric	3 56 3 62	20	Trackwork. (86/19) <u>Until 10.00</u> <u>Wednesday 20</u> <u>August.</u>
<u>Warning board at 4m. 23chs. (on the Up Main line) applies only to trains proceeding over the Up Electric line towards Bow Jn. Until 14 00 Wednesday 20 August.</u>					
4 Ilford Car Sheds and Seven Kings	Down Main	-	8 28 8 37	40	Trackwork. From 14.00 <u>Friday 22</u> <u>August.</u> (86/21)

SECTION A - TEMPORARY SPEED RESTRICTIONS - continued

Location	Lines affected		Mileage		Restr- iction m.p.h.	Remarks
			M. Ch.	M. Ch.		
<u>LIVERPOOL STREET TO NORWICH - continued</u>						
5	Seven Kings and Ilford Car Sheds	-	Up Electric	8 37	8 28	40 Trackwork - From 14.00 Friday 22 August. (86/21)
6	Goodmayes Station and Ilford Car Sheds	-	Up Main	8 55	8 40	40 Condition of track. (85/65)
7	Harold Wood and Brentwood	Down Main	-	15 02	15 42	<u>20</u> 40 Condition of track. (85/61)
8	Brentwood and Shenfield	Down Main	-	18 30 †	19 44	30 Trackwork. (86/14)
9	Brentwood and Ingatestone	Down Main	-	19 65	20 33	50 Condition of track. (86/14)
10	Shenfield and Brentwood	-	Up Main	18 37	18 22	40 Condition of track. (86/12)
11	Shenfield and Brentwood	-	Up Main	19 44 †	18 37	20 Trackwork. (86/14)
12	Shenfield Jn and Brentwood	-	Up Main	20 22	20 08	50 Condition of track. (86/14)
13	Chelmsford and New Hall G.F.	Down	-	30 50	30 65	50 Condition of track. (86/12)
14	New Hall G.F. and Hatfield Peverel	Down	-	34 40 †	34 60	40 Trackwork. (86/18)
15	New Hall G.F. and Witham	Down	-	34 60	38 40	60 Condition of track. (86/17)

SECTION A - TEMPORARY SPEED RESTRICTIONS - continued

Location	Lines affected		Mileage at or between		Restr- iction m.p.h.	Remarks
			M. Ch.	M. Ch.		
<u>LIVERPOOL STREET TO NORWICH - continued</u>						
16 Witham and Church Street LC	Down	-	38 55	39 16	30	Earthwork. From <u>07.00</u> until <u>16.00</u> <u>Sunday 17</u> <u>August.</u>
17 Church Street LC - and Witham		Up	39 16 †	38 55	20	Earthwork. (86/19)
18 Kelvedon	-	Up	42 25	42 10	<u>50</u> 80	Condition of track. (86/7)
19 Newton Flotman LC and Moulton LC	-	Up	104 61	104 45	40	Trackwork. Until <u>10 00</u> <u>Tuesday 19</u> <u>August.</u> (86/20)

SHENFIELD JN TO SOUTHEND VICTORIA

20 Billericay and Wickford Station	Down	-	26 10	26 44	40	Condition of track. (86/14)
21 Wick Lane LC and Rayleigh	Down	-	31 35	31 75	40	Condition of embankment. (84/41)

WICKFORD JN TO SOUTHMINSTER

22 Althorne LC and Burnham-on- Crouch	Single		41 10 †	42 10	20	Trackwork. (85/45)
---	--------	--	---------	-------	----	-----------------------

COLCHESTER TO CLACTON

23 Colchester Road LC and Frating LC	Down		59 14	59 58	20	Trackwork. (86/17) Until <u>10 00</u> <u>Friday 22</u> <u>August</u>
--	------	--	-------	-------	----	--

SECTION A - TEMPORARY SPEED RESTRICTIONS - continued

Location	Lines affected	Mileage at or between		Restr- iction m.p.h.	Remarks
		M. Ch. M.	Ch. m.p.h.		
<u>MANNINGTREE SOUTH JN. TO HARWICH</u>					
24 Bradfield LC and Wrabness	Down -	-	63 37 63 39	40	Earthwork. (85/55)
25 Parkeston Goods Jn and Wrabness	-	Up	66 70 66 10	<u>30</u> 50	Condition of track. (86/3)
<u>EAST SUFFOLK JN TO OULTON BROAD NORTH JN</u>					
26 Bealings LC and Westerfield Jn	-	Up	74 60 † 73 44	20	Trackwork From 09 00 <u>Friday 22</u> <u>August</u> (86/21)
<u>NORWICH TO LOWESTOFT</u>					
27 Thorpe Jn and Whitlingham Jn	Down	Up	0 36 0 44	20	Trackwork. (85/20)
<u>REEDHAM JN TO YARMOUTH</u>					
28 Reedham Jn and Berney Arms	Single		13 52 15 60	30	Condition of track. (86/13) <u>Until 10 00</u> <u>Monday 18</u> <u>August.</u>
<u>W.e.f. 10 00 hrs Monday 18 August, the above speed restriction becomes permanent and appears in Section 'D' of this notice.</u>					
<u>BETHNAL GREEN JN. TO KING'S LYNN</u>					
29 Brimsdown and Waltham Cross	Down	Up	11 54 12 12	20	Trackwork.
30 Slupe Lane LC and Cheshunt Station	-	Up	15 55 15 35	50	Condition of track. (86/4)
31 Broxbourne Jn and Roydon	Down	Up	19 43 † 20 05	20	Trackwork. (86/19)

SECTION A - TEMPORARY SPEED RESTRICTIONS - continued

Location	Lines affected		Mileage		Restr- iction m.p.h.	Remarks	
			N. Ch.	S. Ch.			
<u>BETHNAL GREEN JN. TO KING'S LYNN - continued</u>							
32	Sawbridgeworth and Harlow Mill	-	Up	24 76	24 70	60	Condition of track. (86/16)
33	Whittlesford and Whittlesford Crossovers	Down	-	49 00	49 10	40	Platform work From 09 00 <u>Monday 18</u> <u>August.</u>
34	Shelford	-	Up	52 37	52 27	40	Platform work. (86/15)
<u>COLDHAM LANE JN TO HAUGHLEY JN</u>							
35	Elmswell	Down	Up	37 00	37 14	40	Trackwork. (86/18)
36	Haughley Jn and Elmswell	-	Up	38 20	37 60	20	Trackwork. (86/11) Until 16 00 <u>Monday 18</u> <u>August</u>
<u>CHIPPENHAM JN TO ELY DOCK JN</u>							
37	Chippenham Jn and Fordham LC	Down	-	2 75	3 05	40	Trackwork. From 22 00 <u>Saturday 16</u> <u>until 15 00</u> <u>Wednesday 20</u> <u>August.</u>
38	Fordham LC and Chippenham Jn	-	Up	3 05	2 75	20	Trackwork. From 22 00 <u>Saturday 16</u> <u>August.</u> (86/21)

SECTION A - TEMPORARY SPEED RESTRICTIONS - continued

Location	Lines affected			Mileage		Restr- iction m.p.h.	Remarks
				at or between			
<u>ELY NORTH JN TO PETERBOROUGH, CRESCENT</u>							
39 Third Drove LC and Welney Road LC	Down	Up	78 00	78 18	20	Condition of track. <u>From 09 00</u> <u>Monday 18</u> <u>August</u> (86/21)	
40 Third Drove LC and Welney Road LC	Down	Up	78 00	78 60	20	Condition of track. (85/58) <u>Until 09 00</u> <u>Monday 18</u> <u>August</u>	
41 Third Drove LC and Welney Road LC	Down	Up	78 42	78 60	20	Condition of track. <u>From 09 00</u> <u>Monday 18</u> <u>August</u> (86/21)	
42 March East Jn and Badgeney Road LC	-	Up Main	85 40	85 29	20	Trackwork. (85/54) <u>Warning board</u> <u>positioned at</u> <u>signal ME.45.</u> <u>Additional</u> <u>warning board</u> <u>provided on</u> <u>the March</u> <u>East Jn. to</u> <u>Wisbech line,</u> <u>positioned at</u> <u>signal ME.52.</u>	
43 Three Horse Shoes and Eastrea LC	Down	-	91 07	91 15	20	Trackwork. <u>From 23 30</u> <u>Saturday 16</u> <u>August.</u> (86/21)	

Warning board at 100m. 23chs. (on the Down line) applies only to trains
proceeding over the Two-Way Goods line to Fly Ash Inspection Siding
connection at Peterborough Station (North).

SECTION A - TEMPORARY SPEED RESTRICTIONS - continued

Location	Lines affected	Mileage at or between		Restr- iction m.p.h.	Remarks
		M. Ch.	M. Ch.		
<u>ELY NORTH JN TO TROWSE LOWER JN</u>					
44 Brandon and Santon LC	Down	-	87 09	87 61	20 Trackwork. (86/17)
45 Eaton LC and Trowse Lower Jn	Down	-	121 60	121 64	40 Condition of bridge. (No. 1640/ 1640A). (85/43) <u>Until 23 00</u> <u>Saturday</u> <u>16 August.</u>
46 Eaton LC and Trowse Lower Jn	Down	-	121 60	121 64	20 Condition of bridge. (No. 1640/ 1640A). <u>From 23 00</u> <u>Saturday</u> <u>16 August.</u> (86/21)
<u>FENCHURCH STREET TO SHOEBURYNESS</u>					
47 Laindon	Down	Up	22 53	23 04	20 Trackwork. (86/14) <u>Until 14 00</u> <u>Friday 22</u> <u>August.</u>
<u>UPPER HOLLOWAY TO BARKING, TILBURY LINE JN WEST</u>					
48 South Tottenham East Jn and Black Horse Road	Down	-	6 45	6 57	20 Condition of track. (85/18)
<u>BARKING, TILBURY LINE JN EAST TO TILBURY RIVERSIDE</u>					
49 Dagenham Dock and Barking Tilbury Line Jn East	-	Up Main	9 60 †	8 05	20 Trackwork. (86/1)

SECTION A - TEMPORARY SPEED RESTRICTIONS - continued

Location	Lines affected	Mileage		Restr- iction	Remarks
		at or between M. Ch. M. Ch.	m.p.h.		
<u>TILBURY RIVERSIDE TO PITSEA</u>					
50 Stanford-le- Hope and Gardners LC	Down -	30 11	30 60	40	Condition of track. (86/1)

SECTION B

TEMPORARY ENGINEERING WORKS

At or between	Lines affected	Remarks
<u>LIVERPOOL STREET TO NORWICH</u>		
UNTIL FURTHER NOTICE		
51	Liverpool Street Station Platform 1	08 00 to 16 00. Bridgework (No. 7). (85/39)
52	Liverpool Street Station Platforms 1 to 10 Inc.	Repairs to station roof. Mechanical equipment in use. (84/41)
53	Liverpool Street Station Platforms 1 to 18 inc.	Cleaning track. (85/21)
54	Liverpool Street Station Platforms 8 and 10	Platform work and construction work. Mechanical equipment in use. (86/14)
55	Bethnal Green Station Down Main and Down and Up Suburban	08 00 to 16 00. Demolition work. (See Section 'D'). (85/41)
56	Bow Jn. All	07 30 to 18 00. Undertrack excavation and earthwork 2m. 70chs. Mechanical equipment in use. (85/31)
57	Stratford and Bow Jn. Up Electric	07 30 to 18 00. Construction work. Mechanical equipment in use. (85/62)
58	Forest Gate Jn. and Ilford All	07 00 to 18 00. Bridgework (No. 75A), 7m. 08chs. Mechanical equipment in use. (85/20)
59	Ilford Station All	08 00 to 17 00. Repairs to station roof and painting station. (86/2)
60	Romford Jn and Gidea Park All	Bridgework (No. 102B). 12m. 48chs. Crane and mechanical equipment in use. (85/54)
61	Ingatestone and Chelmsford Down and Up	07 30 to 18 00. Construction of bridge (No. 143A) 26m. 51chs. Mechanical equipment in use. (84/35)
62	Chelmsford and Hatfield Peverel Down and Up	07 30 to 16 00. Earthwork 35m. 53chs. (85/27)

SECTION B - TEMPORARY ENGINEERING WORKS - continued

<u>At or between</u>	<u>Lines affected</u>	<u>Remarks</u>
----------------------	-----------------------	----------------

LIVERPOOL STREET TO NORWICH - continued

UNTIL FURTHER NOTICE - continued

63	Colchester Jn. and Ardleigh LC	Down	08 00 to 17 00. Earthwork and formation renewal. 52m. 25chs. and 53m. 75chs. Mechanical equipment in use. (85/41)
64	Manningtree North Jn. and Bentley LC	Down and Up <u>Between Trains</u>	07 00 to 18 00. Tree felling, bridgework (No. 229) and earthwork 60m. 06chs. and 61m. 06chs. Crane and mechanical equipment in use. (85/15)
65	Ipswich Goods Jn and Needham Market	Down Main	08 00 to 16 00. Construction work. 69% and 76m.p. (86/19)
66	East Suffolk Jn. and Claydon LC	Down and Up	08 00 to 16 00. Bridgework (No.254A). 70m. 17chs. (85/58)
67	Mellis	Down and Up	07 30 to 18 00. Demolition work 91½mp. Mechanical equipment in use. (86/12)
68	Mellis and Trowse Lower Jn	All <u>Between Trains</u>	07 30 to 18 00. Signalling work. Points and signals disconnected. (86/15)
69	Diss and Mellis	Up	08 00 to 15 00. Construction work. 94m. 05chs. and 94m.p. (86/17)
70	Diss	Down and Up	07 00 to 19 00. Earthwork. Crane and mechanical equipment in use. (85/27)
71	Diss and Ardley End LC	Down and Up	Bridgework (No. 315). 95m. 29chs. (86/16)
72	Diss and Tivetshall Jn	Down and Up	07 30 to 18 00. Demolition work 97m 50chs. Mechanical equipment in use. (86/12)
73	Tivetshall Jn	Down and Up	07 30 to 18 00. Demolition work. 100½m.p. Mechanical equipment in use. (86/8)

SECTION B - TEMPORARY ENGINEERING WORKS - continued

<u>At or between</u>	<u>Lines affected</u>	<u>Remarks</u>
<u>LIVERPOOL STREET TO NORWICH - continued</u>		
UNTIL FURTHER NOTICE - continued		
74 Tivetshall Jn and Swainsthorpe	Down and Up <u>Between Trains</u>	07 30 to 18 00. Bridgework (Nos. 328 and 331A) and demolition work. 103m. 13chs. and 104m. 59chs. Crane and mechanical equipment in use. (86/8)
75 Swainsthorpe	Down and Up <u>Between Trains</u>	07 30 to 18 00. Demolition work. 109 $\frac{1}{2}$ m.p. Mechanical equipment in use. (86/8)
76 Trowse Lower Jn and Norwich Station	All <u>Between Trains</u>	07 00 to 17 00. Construction work (overhead line), earthwork, track maintenance and signalling work. Points and signals disconnected. (86/7)
77 Trowse Swing Bridge	Down and Up <u>Between Trains</u>	Bridgework (No. 356). 123m. 36chs. Crane and mechanical equipment in use. (85/33)
78 Trowse Swing Bridge and Thorpe Jn	Down and Up <u>Between Trains</u>	07 30 to 18 00. Construction work. 123 $\frac{1}{2}$ m.p. Crane and mechanical equipment in use. (86/3)
79 Norwich Station	All	Track renewal, platform work and earthwork. Crane and mechanical equipment in use. (85/62)

FRIDAY/SATURDAY 15/16 AUGUST

80 Bethnal Green and Stratford (London End)	Down and Up Electric BLOCKED	23 00 to 05 00. Overhead line work and track maintenance. Mechanical equipment in use. <u>Isolation of electrical sections 309A, 310B.</u> <u>Trains to travel over Main lines.</u>
---	------------------------------------	--

SATURDAY 16 AUGUST

81 Liverpool Street and Bethnal Green	Down and Up Suburban)08 00 to 17 00. Demolition work.)0m.p. and 1m. 10chs.))
Liverpool Street Station	Platforms 1 to 10 inc.)))

SECTION B - TEMPORARY ENGINEERING WORKS - continued

At or between	Lines affected	Remarks
---------------	----------------	---------

LIVERPOOL STREET TO NORWICH - continued

SATURDAY 16 TO SUNDAY 17 AUGUST

82	Bethnal Green and Forest Gate Jn	Down and Up Electric BLOCKED	23 00 Sat to 23 00 Sun. Track maintenance, track renewal, construction work, overhead line work, signalling work and bridgework (No.28). Mechanical equipment in use. <u>Isolation of electrical sections 309A, 310B, 317CD, 318AB.</u> <u>Trains to travel over Main lines.</u>
83	Gidea Park Jn and Shenfield (London End)	Down and Up Main BLOCKED)21 15 Sat to 22 00 Sun. Track)maintenance, reballasting,)signalling work and overhead line)work. Mechanical equipment in use.) <u>Isolation of electrical sections)331D, 332A. Trains to travel over)<u>Electric lines.</u></u>
	Shenfield	Platform 1/ Up Passenger Loop) BLOCKED)	
84	Diss and Tivetshall Jn	Down and Up	07 00 Sat to 20 00 Sun. Signalling work (Gissing LC). Crane in use.

SATURDAY/SUNDAY 16/17 AUGUST

85	New Hall G.F. and Witham (London End)	Up BLOCKED Down BLOCKED	23 10 to 06 30)Track maintenance and)track renewal. 23 50 to 07 00) <u>Possession to be given)up for passage of)<u>trains.</u></u>
----	---------------------------------------	----------------------------------	--

SECTION B - TEMPORARY ENGINEERING WORKS - continued

At or between	Lines affected	Remarks
<u>LIVERPOOL STREET TO NORWICH - continued</u>		
SATURDAY/SUNDAY 16/17 AUGUST - continued		
86 Witham (London End) and Kelvedon	Up Main BLOCKED Down Main BLOCKED	23 00 to 16 00)Track maintenance,)reballasting and 23 55 to 07 15)overhead line work.)Crane and mechanical)equipment in use.)23 55 Sat to 07 15) <u>Possession to be given up for passage of 1Y02</u>) <u>02 20 Liverpool Street to Stowmarket and 1F46</u>) <u>03 15 Liverpool Street to Witham over Down/</u>) <u>Down Passenger Loop/</u>) <u>Down line. 07 15 to</u>) <u>16 00 Sun. Single line</u>) <u>working over Down</u>) <u>Main line.</u>
87 Manningtree South Jn. and Ardleigh LC	Up BLOCKED	23 30 to 06 00. Trimming lineside vegetation. Mechanical equipment in use.
88 Ipswich Station	Platform 4 BLOCKED	23 15 to 08 00. Earthwork and drainage. Mechanical equipment in use. <u>Trains to be replatformed as necessary.</u>
89 Ipswich Goods Jn and Claydon LC	All BLOCKED	23 40 to 06 30. Track maintenance and track renewal. Mechanical equipment in use. <u>Possession to be given up for passage of trains.</u>
90 Haughley Jn. and Diss	Down and Up BLOCKED	23 30 to 07 25. Track renewal and unloading materials. Mechanical equipment in use.
91 Tivetshall Jn. and Swainsthorpe	Up BLOCKED Down BLOCKED	22 00 to 16 00)Drainage, unloading)materials and 23 55 to 07 00)demolition work.)Mechanical equipment)in use. <u>07 00 to</u>) <u>16 00 Sun. Single line</u>) <u>working over Down</u>) <u>line.</u>

SECTION B - TEMPORARY ENGINEERING WORKS - continued

At or between	Lines affected	Remarks
<u>LIVERPOOL STREET TO NORWICH - continued</u>		
SATURDAY/SUNDAY 16/17 AUGUST		
92 Swainsthorpe and Trowse Upper Jn	Up BLOCKED Down BLOCKED	22 00 to 06 45)Demolition work.)109%mp. Mechanical 23 55 to 10 15)equipment in use.)
93 Trowse Upper Jn and Trowse Yard	Up BLOCKED Down BLOCKED	23 00 to 07 00)Construction work)(overhead line). 23 59 to 07 00)Crane in use.) <u>Possession to be given</u>) <u>up for passage of 1P04</u>) <u>02 10 Liverpool Street</u>) <u>to Yarmouth over Down</u>) <u>line.</u>
94 Trowse Yard and Norwich Station	'C' line/ Up Main BLOCKED Down Main/ 'W' line BLOCKED	22 00 to 07 00)Track renewal,)reballasting, and)signalling work. 23 00 to 16 00)Crane and mechanical)equipment in use.) <u>23 00 Sat to 07 00</u>) <u>Possession to be</u>) <u>given up for</u>) <u>passage of 1P04</u>) <u>02 10 Liverpool</u>) <u>Street to Yarmouth</u>) <u>over Up Main/'C'</u>) <u>line under Single</u>) <u>line working.</u>) <u>07 00 to 16 00 Sun</u>) <u>Single line working</u>) <u>over 'C' line/Up</u>) <u>Main line. (See</u>) <u>Section 'C').</u>

SECTION B - TEMPORARY ENGINEERING WORKS - continued

At or between	Lines affected	Remarks
<u>LIVERPOOL STREET TO NORWICH - continued</u>		
SUNDAY 17 AUGUST - continued		
98 Manor Park and Ilford Station	Down and Up Main and Down and Up Electric BLOCKED	00 15 to 06 35. Bridgework (No. 75A) 7m. 08chs. Crane and mechanical equipment in use. <u>Diesel trains to travel over Avoiding lines.</u>
99 Ilford Station Jn and Ilford CS (London End)	Down Main, Up Electric BLOCKED	00 15 to 06 35. Platform work. <u>Down Diesel trains to travel over Down Electric line. Up Diesel trains to travel over Up Main line.</u>
100 Witham (London End) and Hill House G.F.	All BLOCKED to electric trains	00 01 to 07 15. In connection with engineering work. <u>Isolation of electrical sections 337 and 338.</u>
101 Colchester (Country End) and East Suffolk Jn	All BLOCKED to electric trains	00 45 to 06 15. In connection with engineering work. <u>Isolation of electrical sections 341, 342, 343 and 344.</u>
102 Manningtree North Jn and Halifax.	All	08 00 to 16 00. Signalling work.
SUNDAY/MONDAY 17/18 AUGUST		
103 Liverpool Street Station	Platforms 11 and 12 (and approaches) and connections between Main lines and Platforms 13 and 14 BLOCKED to electric trains	23 15 to 05 00. Repairs to station roof. <u>Isolation of electrical sections 304ABE. Electric trains travelling to/from Platforms 13 and 14 to travel over Electric lines. Electric trains to be replatformed as necessary.</u>
104 Tivetshall Jn and Swainsthorpe	Down BLOCKED	23 00 to 04 00. Unloading materials. <u>Single line working over Up line.</u>

SECTION B - TEMPORARY ENGINEERING WORKS - continued

<u>At or between</u>	<u>Lines affected</u>	<u>Remarks</u>
----------------------	-----------------------	----------------

LIVERPOOL STREET TO NORWICH - continued

MONDAY 18 TO WEDNESDAY 20 AUGUST - continued

110	Trowse Lower Jn. and Trowse Swing Bridge	Down and Up BLOCKED	23 00 Mon and Tue to 05 00 Tue and Wed Track maintenance and track renewal. Crane and mechanical equipment in use. <u>Possession to be given up for passage of trains.</u>
-----	--	------------------------	--

MONDAY 18 TO THURSDAY 21 AUGUST

111	Gidea Park Jn and Shenfield (London End Jn)	Down and Up Main BLOCKED	10 15 to 15 15 daily. Track maintenance. Mechanical equipment in use. <u>Trains to travel over Electric lines.</u>
-----	---	-----------------------------	--

MONDAY 18 TO FRIDAY 22 AUGUST

112	New Hall and Witham	Down BLOCKED	23 00 Mon to Thu to 05 30 Tue to Fri. Track maintenance. <u>Possession to be given up for passage of trains.</u>
-----	---------------------	-----------------	---

MONDAY 18 TO SATURDAY 23 AUGUST

113	Bethnal Green and Stratford (London End)	Down and Up Electric BLOCKED	23 00 Mon to Fri to 05 00 Tue to Sat. Overhead line work. Mechanical equipment in use. <u>Isolation of electrical sections 309A, 310B.</u> <u>Trains to travel over Main lines.</u>
-----	--	------------------------------------	---

TUESDAY 19 TO FRIDAY 22 AUGUST

114	Gidea Park Jn and Shenfield (London End Jn)	Down and Up Electric BLOCKED	00 30 to 05 00 daily. Track maintenance. Mechanical equipment in use. <u>Possession given up for passage of 1K12 03 35 Liverpool Street to Southend Victoria over Down Electric line. Southend trains to travel over Down and Up Southend lines. Other trains to travel over Main lines.</u>
-----	---	------------------------------------	--

115 Not used.

SECTION B - TEMPORARY ENGINEERING WORKS - continued

<u>At or between</u>	<u>Lines affected</u>	<u>Remarks</u>
----------------------	-----------------------	----------------

LIVERPOOL STREET TO NORWICH - continued

TUESDAY 19 AUGUST

116 Liverpool Street Station	Platform 10 BLOCKED	10 00 to 15 30. Repairs to station roof. Mechanical equipment in use. <u>Isolation of electrical sections 305H. Trains to be replatformed as necessary.</u>
------------------------------	------------------------	---

WEDNESDAY 20 TO FRIDAY 22 AUGUST

117 Manningtree North Jn and Halifax Jn	Down BLOCKED	23 30 Wed and Thu to 05 00 Thu and Fri. Track maintenance and overhead line work. Mechanical equipment in use. <u>Isolation of electrical sections 344B. Single line working over Up line.</u>
---	-----------------	--

WEDNESDAY 20 TO FRIDAY 22 AUGUST

118 Swainsthorpe and Trowse Upper Jn	Down and Up BLOCKED	23 00 Wed and Thu to 05 00 Thu and Fri. Track maintenance and track renewal. Crane and mechanical equipment in use. <u>Possession to be given up for passage of trains.</u>
--------------------------------------	------------------------	---

THURSDAY 21 AUGUST

119 Liverpool Street Station	Platform 10 BLOCKED	10 00 to 15 30. Repairs to station roof. Mechanical equipment in use. <u>Isolation of electrical sections 305H. Trains to be replatformed as necessary.</u>
------------------------------	------------------------	---

FRIDAY 22 AUGUST

120 Stanway GF and Hill House GF	Up BLOCKED	00 01 to 04 40. Track maintenance and overhead line work. Mechanical equipment in use. <u>Isolation of electrical sections 339FGH. Single line working over Down line.</u>
----------------------------------	---------------	--

SECTION B - TEMPORARY ENGINEERING WORKS - continued

At or between	Lines affected	Remarks
---------------	----------------	---------

STRATFORD CENTRAL JN EAST TO COPPER MILL NORTH JN

SUNDAY 17 AUGUST

121 Temple Mills West Jn and Copper Mill North Jn	Down and Up Main BLOCKED	08 00 to 18 00. Loading rails and materials. Crane in use. <u>Possession to be given up for passage of Engineers' trains.</u>
---	-----------------------------	---

NAVARINO ROAD JN TO NORTH WOOLWICH

UNTIL FURTHER NOTICE

122 Highbury and Homerton	All	07 30 to 18 00. Earthwork and construction work. Mechanical equipment in use. (86/1)
---------------------------	-----	---

SUNDAY 17 AUGUST

123 Navarino Road Jn and Channelsea North Jn	Down and Up BLOCKED	00 01 to 08 00. Construction work (overhead line). Crane and mechanical equipment in use. <u>Isolation of electrical sections 707 and 708. Possession to be given up for passage of 1P04 02 10 Liverpool Street to Yarmouth (diverted) and 1H02 03 10 Liverpool Street to King's Lynn (diverted) over Up line.</u>
124 Channelsea North Jn and Stratford Central Jn West	Down and Up BLOCKED	00 01 to 08 00. Construction work (overhead line). <u>Isolation of electrical sections 705C, 706A.</u>

STRATFORD, LEA JN TO HIGH MEADS JN

SUNDAY 17 AUGUST

125 Lea Jn and High Meads Jn	Down and Up BLOCKED	00 01 to 08 00. Construction work (overhead line). Crane and mechanical equipment in use.
------------------------------	------------------------	---

SECTION B - TEMPORARY ENGINEERING WORKS - continued

At or between	Lines affected	Remarks
---------------	----------------	---------

CHANNELSEA SOUTH JN TO STRATFORD CENTRAL JN WEST

UNTIL FURTHER NOTICE

126	Channelsea South Jn and Stratford Central Jn West	Down and Up BLOCKED to electric trains	In connection with engineering work. (86/14)
-----	---	--	---

, SUNDAY 17 AUGUST

127	Channelsea North Jn and Stratford Central Jn West	Down and Up	00 01 to 08 00. Construction work (overhead line). <u>Isolation of electrical sections 705C, 706A.</u>
-----	---	-------------	--

FOREST GATE JN TO WOODGRANGE PARK JN

SUNDAY 17 AUGUST

128	Forest Gate Jn and Barking Tilbury Line Jn West	Down and Up BLOCKED to electric trains	00 50 to 18 00. In connection with engineering work. <u>Isolation of electrical sections 512AB, 513EF.</u>
-----	---	--	--

ROMFORD TO UPMINSTER

SUNDAY 17 AUGUST

129	Romford and Upminster	Single	08 00 to 18 00. Signalling work.
-----	-----------------------	--------	----------------------------------

SHENFIELD JN TO SOUTHEND VICTORIA

UNTIL FURTHER NOTICE

130	Billericay	Down and Up	07 30 to 17 30. Construction work and platform work. Mechanical equipment in use. (86/19)
131	Wickford Station	All	Platform work and earthwork. (85/63)

SECTION B - TEMPORARY ENGINEERING WORKS - continued

At or between	Lines affected	Remarks
---------------	----------------	---------

SHENFIELD JN TO SOUTHEND VICTORIA - continued

UNTIL FURTHER NOTICE - continued

132	Wickford Jn	All	08 00 to 17 00. Signalling work. (85/41)
133	Rayleigh and Hockley	Down	08 00 to 17 00. Earthwork 34½ and 34¾ m.p. Mechanical equipment in use. (85/61)
134	Southend Victoria Station	All	08 00 to 18 00. Repairs to station roof. (86/20)

SATURDAY 16 AUGUST

135	Southend Victoria Station	Platforms 2 and 3 BLOCKED	08 00 to 18 00. Repairs to station roof. <u>Isolation of electrical sections 375A, 376H. Trains to be replatformed as necessary.</u>
-----	---------------------------------	---------------------------------	---

WICKFORD JN TO SOUTHMINSTER

UNTIL FURTHER NOTICE

136	Wickford Jn	All	08 00 to 17 00. Signalling work. (85/41)
137	Fambridge Station	Single	07 30 to 18 00. Platform work. (85/55)
138	Burnham-on- Crouch	Single	07 30 to 18 00. Earthwork. 43m 24chs. (85/30)

MONDAY 18 TO SATURDAY 23 AUGUST

139	Wickford Jn and Southminster	Single BLOCKED	23 59 Mon to Fri to 04 45 Tue to Sat. Overhead line work. Mechanical equipment in use. <u>Isolation of electrical sections 377.</u>
-----	------------------------------------	-------------------	---

SECTION B - TEMPORARY ENGINEERING WORKS - continued

<u>At or between</u>	<u>Lines</u>	<u>Remarks</u>
	<u>affected</u>	

WITHAM TO BRAINTREE

UNTIL FURTHER NOTICE

140 Witham and Braintree	Single	07 00 to 18 00. Construction work (Bridge No. 2102B). (86/19)
--------------------------	--------	--

SUNDAY 17 AUGUST

141 Witham and Braintree	Single BLOCKED to electric trains	00 01 to 07 15. In connection with engineering work between Witham and Kelvedon. <u>Isolation of electrical sections 379.</u>
--------------------------	---	---

MONDAY 18 AUGUST

142 Witham and Braintree	Single BLOCKED to electric trains	01 20 to 04 20. In connection with engineering work between Witham and Kelvedon. <u>Isolation of electrical sections 379.</u>
--------------------------	---	---

MONDAY 18 TO FRIDAY 22 AUGUST

143 Witham and Braintree	Single	07 00 to 17 00 daily. Bridgework (No. 2105A). 23m. 37chs.
144 Witham and Braintree	Single BLOCKED	23 45 Mon to Thu to 05 30 Tue to Fri. Bridgework (No. 2105A). 23m. 37chs. <u>Isolation of electrical sections 379.</u>

COLCHESTER TO CLACTON

UNTIL FURTHER NOTICE

145 Colchester Jn and East Gate Jn	Down Clacton Avoiding	08 00 to 17 00. Earthwork. 52m. 25chs. and 52m. 29chs. Mechanical equipment in use. (85/38)
------------------------------------	--------------------------	--

SECTION B - TEMPORARY ENGINEERING WORKS - continued

At or between	Lines affected	Remarks
COLCHESTER TO CLACTON - continued		
SATURDAY/SUNDAY 16/17 AUGUST		
146 Colchester Jn and Alresford	Down and Up BLOCKED	23 30 to 07 45. Level crossing road repairs (Hythe LC). 53m. 14chs. and 53m. 53chs. Mechanical equipment in use. <u>Possession to be given up for passage of Engineers' trains.</u>
147 Alresford and Great Bentley	Up BLOCKED Down BLOCKED	23 30 to 07 15) Track maintenance,) track renewal and 23 30 to 16 00) overhead line work.) Crane and mechanical) equipment in use.) <u>07 15 to 16 00 Sun.</u>) <u>Isolation of electrical</u>) <u>sections 384A. Single</u>) <u>line working over Up</u>) <u>line.</u>
SUNDAY 17 AUGUST		
148 Alresford and Clacton	All BLOCKED to electric trains	00 10 to 07 15. In connection with engineering work between Alresford and Great Bentley. <u>Isolation of electrical sections 383, 384, 385 and 386.</u>
149 Thorpe-le-Soken and Clacton	Down and Up BLOCKED	00 10 to 07 30. Track maintenance and unloading rails. 68½ and 68¾m.p. Mechanical equipment in use.
MONDAY 18 TO WEDNESDAY 20 AUGUST		
150 East Gate Jn and Thorpe-le-Soken	Down BLOCKED to electric trains	23 30 Mon and Tue to 04 45 Tue and Wed. In connection with engineering work. <u>Isolation of electrical sections 382BC and 384.</u>
MONDAY 18 TO FRIDAY 22 AUGUST		
151 East Gate Jn and Thorpe-le-Soken	Down and Up BLOCKED	23 30 Mon to Thu to 04 45 Tue to Fri. Track maintenance and trimming lineside vegetation. Mechanical equipment in use. <u>Possession to be given up for passage of Freight trains to/from Hythe.</u>

SECTION B - TEMPORARY ENGINEERING WORKS - continued

At or between	Lines affected	Remarks
---------------	----------------	---------

COLCHESTER TO CLACTON - continued

WEDNESDAY 20 TO FRIDAY 22 AUGUST

152	Thorpe-le-Soken Up and East Gate Jn	BLOCKED to electric trains	23 30 Wed and Thu to 04 45 Thu and Fri. In connection with engineering work. <u>Isolation of electrical sections 381AB and 383.</u>
-----	---	-------------------------------	---

THORPE-LE-SOKEN TO WALTON-ON-NAZE

SUNDAY 17 AUGUST

153	Thorpe-le-Soken Single and Walton-on- Naze	BLOCKED to electric trains	00 10 to 07 15. In connection with engineering work between Alresford and Great Bentley. <u>Isolation of electrical sections 387.</u>
-----	--	-------------------------------	---

MANNINGTREE SOUTH JN TO HARWICH

UNTIL FURTHER NOTICE

154	Mistley Station	Down and Up	07 30 to 16 00. Platform work. Mechanical equipment in use. (85/50)
155	Wrabness and Mistley	Up	07 30 to 17 00. Earthwork. 64m. 46chs. and 64m. 15chs. Mechanical equipment in use. (85/65)
156	Wrabness Station	Down and Up	07 30 to 18 00. Platform work. Mechanical equipment in use. (85/58)
157	Parkeston Quay Station	All <u>Between Trains</u>	07 30 to 18 00. Platform work. Mechanical equipment in use. (85/58)
158	Parkeston Quay Yard	All	07 30 to 16 00. Track maintenance in connection with remodelling of sidings. Mechanical equipment in use. (84/10)
159	Parkeston West and Harwich Town	Single	07 30 to 18 00. Track maintenance, track renewal and earthwork. 70 $\frac{1}{2}$ m.p. Mechanical equipment in use. (85/27)

SECTION B - TEMPORARY ENGINEERING WORKS - continued

<u>At or between</u>	<u>Lines affected</u>	<u>Remarks</u>
----------------------	-----------------------	----------------

MANNINGTREE SOUTH JN TO HARWICH - continued

SUNDAY 17 AUGUST

160 Manningtree South Jn and Harwich Town	All BLOCKED to electric trains	00 45 to 06 15. In connection with engineering work between Colchester and East Suffolk Jn. <u>Isolation of electrical sections 391 and 392.</u>
161 Parkeston Goods Jn and Dovercourt	All BLOCKED	00 45 to 06 15. Loading and unloading materials.

MONDAY 18 TO WEDNESDAY 20 AUGUST

162 Mistley and Wrabness	Down and Up BLOCKED	23 00 Mon and Tue to 05 00 Tue and Wed. Track maintenance. <u>Possession to be given up for passage of trains.</u>
--------------------------	------------------------	--

WEDNESDAY/THURSDAY 20/21 AUGUST

163 Wrabness and Manningtree East Jn	Up BLOCKED	23 15 to 04 45. Track maintenance. <u>Single line working over Down line.</u>
--------------------------------------	---------------	---

THURSDAY/FRIDAY 21/22 AUGUST

164 Manningtree East Jn and Wrabness	Down BLOCKED	23 15 to 04 45. Track maintenance. <u>Single line working over Down line.</u>
--------------------------------------	-----------------	---

MANNINGTREE EAST JN TO NORTH JN

SUNDAY 17 AUGUST

165 Manningtree East Jn and Manningtree North Jn	Single BLOCKED to electric trains	00 45 to 06 15. In connection with engineering work. <u>Isolation of electrical sections 343 and 392.</u>
--	---	---

EAST SUFFOLK JN TO OULTON BROAD NORTH JN

UNTIL FURTHER NOTICE

166 Melton and Wickham Market	Single	07 00 to 18 00. Bridgework (No. 426). 81m. 11chs. Crane in use.
-------------------------------	--------	---

SECTION B - TEMPORARY ENGINEERING WORKS - continued

At or between	Lines affected	Remarks
---------------	----------------	---------

EAST SUFFOLK JN TO OULTON BROAD NORTH JN - continued

UNTIL FURTHER NOTICE - continued

167	Oulton Broad North Jn	All	08 00 to 17 00. Signalling work. (85/41)
-----	--------------------------	-----	---

SATURDAY/SUNDAY 16/17 AUGUST

168	Westerfield Jn and Woodbridge	Down and Up BLOCKED	23 10 to 10 00. Track renewal and trimming lineside vegetation. Mechanical equipment in use.
169	Oulton Broad South and Oulton Broad North Jn	Single BLOCKED	22 30 to 07 45. Track maintenance. 116 $\frac{1}{2}$ m.p. and 116m. 25chs. Crane and mechanical equipment in use.

MONDAY 18 TO THURSDAY 21 AUGUST

170	Woodbridge and Westerfield Jn	Up BLOCKED	23 15 Mon to Wed to 06 15 Tue to Thu. Track maintenance. Mechanical equipment in use.
-----	----------------------------------	---------------	---

WEDNESDAY/THURSDAY 20/21 AUGUST

171	Woodbridge and Saxmundham	All BLOCKED	23 15 to 06 15. Track maintenance. Mechanical equipment in use.
-----	------------------------------	----------------	--

WESTERFIELD JN TO FELIXSTOWE

UNTIL FURTHER NOTICE

172	Westerfield Jn and Derby Road	Single	08 00 to 16 00. Earthwork. 73m. 13chs. and 73 $\frac{1}{2}$ m.p. (85/61)
173	Derby Road and Felixstowe Beach Jn	Single	07 30 to 17 00. Earthwork. 82 $\frac{1}{2}$ and 83m.p. Mechanical equipment in use. (86/1)

SATURDAY/SUNDAY 16/17 AUGUST

174	Derby Road and Trimley	Single BLOCKED	23 00 to 06 30. Track maintenance and track renewal. Crane and mechanical equipment in use.
-----	---------------------------	-------------------	---

SECTION B - TEMPORARY ENGINEERING WORKS - continued

<u>At or between</u>	<u>Lines</u>	<u>Remarks</u>
	<u>affected</u>	

SAXMUNDHAM JN TO SIZEWELL

MONDAY 18 TO FRIDAY 22 AUGUST

175	Saxmundham Jn and Sizewell	Single	08 00 to 16 00 daily. Track maintenance.
-----	-------------------------------	--------	---

NORWICH TO LOWESTOFT

UNTIL FURTHER NOTICE

176	Norwich Station	All	Track renewal, platform work and earthwork. Crane and mechanical equipment in use. (85/62)
177	Norwich Station and Trowse Lower Jn	All <u>Between Trains</u>	07 00 to 17 00. Construction work (overhead line), earthwork, track maintenance and signalling work. Points and signals disconnected. (86/7)
178	Thorpe Jn	All	08 00 to 17 00. Earthwork and track maintenance. (85/22)
179	Whitlingham Jn and Thorpe Jn	Up	07 30 to 17 00. Earthwork 1½ and 1m.p. Mechanical equipment in use. (86/13)
180	Whitlingham Jn and Brundall Jn	Down and Up	07 00 to 16 00. Signalling work.
181	Brundall Jn and Reedham Swing Bridge	Down and Up	07 00 to 18 00. Earthwork. 7m. 34chs. and signalling work. (85/16)
182	Oulton Broad North Jn	All	08 00 to 17 00. Signalling work. (85/41)

SATURDAY/SUNDAY 16/17 AUGUST

183	Cantley and Reedham Jn	Down and Up BLOCKED	23 40 to 06 40. Level Crossing road repairs (Cantley Road LC). 10m. 05chs and 10m. 06chs. Mechanical equipment in use. <u>Possession to be given up for passage of trains.</u>
-----	------------------------------	------------------------	---

SECTION B - TEMPORARY ENGINEERING WORKS - continued

At or between	Lines affected	Remarks
---------------	----------------	---------

NORWICH TO LOWESTOFT - continued

SATURDAY/SUNDAY 16/17 AND SUNDAY 17 AUGUST

184	Oulton Broad North Jn and Lowestoft	Up BLOCKED Down BLOCKED	22 30 Sat to 07 45 00 10 to 07 45 Sun)Track maintenance)22m. 10chs. and)22m. 20chs. Crane)and mechanical)equipment in use.) <u>Possession to be</u>) <u>given up for</u>) <u>passage of trains.</u>
-----	---	----------------------------------	--	--

SUNDAY 17 TO FRIDAY 22 AUGUST

185	Thorpe Jn and Norwich Station Platforms 1, 2 and 3	'C' and 'W' lines BLOCKED)23 15 Sun to Thu to 05 00 Mon to Fri.)Construction work (overhead line).)Crane and mechanical equipment in)use. <u>Possession to be given up for</u>) <u>passage of trains.</u>)))
-----	--	-------------------------------------	---

MONDAY/TUESDAY 18/19 AUGUST

186	Cantley and Reedham Jn	Down and Up BLOCKED	23 40 to 05 30.	Track maintenance and loading rails. Crane and mechanical equipment in use.
-----	------------------------------	------------------------	-----------------	---

WHITLINGHAM JN TO CROMER

UNTIL FURTHER NOTICE

187	Whitlingham Jn and Wroxham	Down and Up	07 30 to 16 30.	Bridgework (No. 365). 3m. 48chs. (86/6)
-----	----------------------------------	-------------	-----------------	---

188	Cromer Station	Platforms 1 and 2	Platform work.	(86/15)
-----	----------------	-------------------	----------------	---------

CROMER TO SHERINGHAM

UNTIL FURTHER NOTICE

189	Cromer Station	Platforms 1 and 2	Platform work.	(86/15)
-----	----------------	-------------------	----------------	---------

SECTION B - TEMPORARY ENGINEERING WORKS - continued

At or between	Lines affected	Remarks
<u>BRUNDALL JN TO YARMOUTH VIA ACLE</u>		
UNTIL FURTHER NOTICE		
190	Lingwood Single	08 00 to 17 00. Construction work. 8m. 03chs. (86/12)
191	Acle Station Down and Up	08 00 to 17 00. Platform work. <u>From 08 00 Monday 11 August.</u> (86/20)
<u>BETHNAL GREEN JN TO KING'S LYNN</u>		
UNTIL FURTHER NOTICE		
192	London Fields and Hackney Downs Down and Up Suburban	07 30 to 18 00. Earthwork and construction work. Mechanical equipment in use. (85/27)
193	Hackney Downs All	08 00 to 17 00. Signalling work. (86/1)
194	Tottenham South Jn and Tottenham Hale Down and Up	Earthwork. Mechanical equipment in use. (85/54)
195	Enfield Lock and Waltham Cross Down and Up	07 00 to 18 00. Bridgework (No.1418C). 12m. 34chs. Crane and mechanical equipment in use. (85/59)
196	Bishops Stortford (Country end) and Stansted Down and Up Main BLOCKED to electric trains	Overhead line work. <u>Isolation of electrical sections 427, 428 (buffer section).</u> (85/41)
197	Bishops Stortford and Cambridge (North) All	07 00 to 18 00. Construction work (overhead line). Mechanical equipment in use. (85/21)
198	Stansted Down and Up	Construction work. 33m. 29chs. (85/61)
199	Elsenham Down and Up	Construction work. 35m. 44chs. (85/61)

SECTION B - TEMPORARY ENGINEERING WORKS - continued

<u>At or between</u>	<u>Lines affected</u>	<u>Remarks</u>
----------------------	-----------------------	----------------

BETHNAL GREEN JN TO KING'S LYNN - continued

UNTIL FURTHER NOTICE - continued

200 Newport	Down and Up	08 00 to 16 00. Platform work 39m. 74chs. Mechanical equipment in use. (85/37)
-------------	-------------	---

201 Whittlesford	Down	Platform work 49m 02chs. Mechanical equipment in use. <u>From 09 00 Monday</u> <u>18 August.</u>
------------------	------	--

202 Shelford	Down and Up	Platform work. 52m. 36chs. Mechanical equipment in use. (86/6)
--------------	-------------	--

SATURDAY/SUNDAY 16/17 AUGUST

203 Spelbrook and Harlow Mill	Up BLOCKED	23 00 to 06 00 Track maintenance 28m. 10chs. and 27 ³ / ₄ m.p.
-------------------------------------	---------------	---

204 Elsenham and Audley End	Up BLOCKED Down BLOCKED	22 20 to 08 20)Construction work) (overhead line). 35% 23 45 to 10 00)and 41 ¹ / ₂ m.p.)Mechanical equipment)in use. <u>1P04 02 10</u>) <u>Liverpool Street to</u>) <u>Yarmouth and 1H02 03 10</u>) <u>Liverpool Street to</u>) <u>King's Lynn diverted</u>) <u>via Finsbury Park and</u>) <u>Hitchin.</u>
--------------------------------	----------------------------------	---

205 Audley End and Whittlesford Crossovers	Up BLOCKED Down BLOCKED	22 15 to 08 15)Track maintenance,)signalling work, and 23 50 to 10 00)construction work) (overhead line). 41 ¹ / ₂)and 49 ³ / ₄ m.p. Mechanical)equipment in use. <u>1P04</u>) <u>02 10 Liverpool Street</u>) <u>to Yarmouth and 1H02</u>) <u>03 10 Liverpool Street</u>) <u>to King's Lynn diverted</u>) <u>via Finsbury Park and</u>) <u>Hitchin.</u>
---	----------------------------------	--

SECTION B - TEMPORARY ENGINEERING WORKS - continued

At or between	Lines affected	Remarks
---------------	----------------	---------

BETHNAL GREEN JN TO KING'S LYNN - continued

SATURDAY/SUNDAY 16/17 AUGUST - continued

206 Cambridge Station	Down Goods Loop South and Platforms 2 and 3 BLOCKED	23 00 to 17 00)Track renewal. 55% and)55% <u>m.p.</u> Crane and)mechanical equipment in)use. <u>Trains to travel</u>) <u>over other lines.</u>)
	Down Main/ Platform 1 BLOCKED	23 50 to 09 00)))

SATURDAY/SUNDAY 16/17 AND SUNDAY 17 AUGUST

207 Cambridge Station and Coldham Lane Jn	Down and Up Goods BLOCKED	22 30 Sat to 07 30)Construction work) <u>(overhead line).</u>)55% and 56% <u>m.p.</u>
	Up Main BLOCKED	01 30 to 03 30 Sun)Mechanical)equipment in use.) <u>Trains to travel</u>) <u>over other lines.</u>
208 Chesterton Jn and Waterbeach	Down BLOCKED	22 30 Sat to 08 00)Earthwork. 58% and)59 <u>m.p.</u> Mechanical)equipment in use.) <u>Possession to be</u>) <u>given up for</u>) <u>passage of 1P04</u>) <u>02 10 Liverpool</u>) <u>Street to Yarmouth</u>) <u>and 1H02 03 10</u>) <u>Liverpool Street to</u>) <u>King's Lynn over</u>) <u>Down line.</u>
	Up BLOCKED	00 05 to 08 00 Sun)))

SATURDAY 16 AND SUNDAY 17 AUGUST

209 Newport	Down <u>Between Trains</u>	08 00 to 16 00 daily.	Platform work 39 <u>m.</u> 74 <u>chs.</u> Mechanical equipment in use.
-------------	-------------------------------	-----------------------	--

SECTION B - TEMPORARY ENGINEERING WORKS - continued

At or between	Lines affected	Remarks
<u>BETHNAL GREEN JN TO KING'S LYNN - continued</u>		
SUNDAY 17 AUGUST		
210 Clapton Jn and Cheshunt Jn	Down and Up Main BLOCKED to electric trains	00 01 to 22 00. In connection with engineering work between Tottenham South Jn and Cheshunt Jn. <u>Isolation of electrical sections 411 and 412. Electric trains diverted via Southbury.</u>
211 Tottenham South Jn and Cheshunt Jn	Down and Up Main BLOCKED	00 01 to 22 00. Track renewal, construction work, repairs to Brimsdown signalbox, drainage and overhead line work. Mechanical equipment in use. <u>1P04 02 10 Liverpool Street to Yarmouth and 1H02 03 10 Liverpool Street to King's Lynn diverted via Finsbury Park and Hitchin. Other trains diverted via Southbury.</u>
212 Broxbourne Jn and Bishops Stortford	All BLOCKED to electric trains	00 35 to 08 30. In connection with engineering work between Broxbourne Jn and Harlow Town. <u>Isolation of electrical sections 415, 416, 417 and 418.</u>
213 Broxbourne Jn and Harlow Town	Up BLOCKED Down BLOCKED	00 15 to 08 45)Track renewal,)bridgework (No. 1436) 00 15 to 16 00)and overhead line work.)Crane and mechanical)equipment in use.)00 15 to 09 00. 1P04)02 10 Liverpool Street)to Yarmouth and 1H02)03 10 Liverpool Street)to King's Lynn diverted)via Finsbury Park and)Hitchin. 08 30 to)16 00 Isolation of)electrical sections)416A. 08 45 to 16 00)Single line working)over Up line.
214 Chesterton Jn and Ely Dock Jn	Down and Up	05 30 to 16 00. Signalling work.

SECTION B - TEMPORARY ENGINEERING WORKS - continued

At or between	Lines affected	Remarks
<u>BETHNAL GREEN JN TO KING'S LYNN - continued</u>		
SUNDAY 17 AUGUST - continued		
215 Ely Station North and Ely North Jn	Down and Up BLOCKED	00 01 to 08 00. Track maintenance 71m. 65chs. <u>Possession to be given up for passage of 1P04 02 10 Liverpool Street to Yarmouth and 1H02 03 10 Liverpool Street to King's Lynn over Down Line.</u>

MONDAY 18 AUGUST

216 Cheshunt Jn (London End) and Bishops Stortford (Country End)	All BLOCKED to electric trains	00 40 to 03 50. In connection with overhead line work between Broxbourne Jn and Harlow Town. <u>Isolation of electrical sections 413, 414, 415, 416, 417 and 418.</u>
217 Broxbourne Jn and Harlow Town	Down and Up BLOCKED	00 40 to 03 50. Overhead line work. <u>Possession to be given up for passage of diesel trains.</u>
218 Shepreth Branch Jn and Cambridge Cambridge Station	Down Goods Loop South BLOCKED Platforms 2 and 3 BLOCKED) 00 01 to 05 30. Construction work) (overhead line). 53% and 55% m.p.) Mechanical equipment in use.) <u>Trains to be replatformed as necessary.</u>

MONDAY/TUESDAY 18/19 AUGUST

219 Broxbourne Jn and Harlow Town	Down BLOCKED	23 15 to 04 15. Track maintenance. Mechanical equipment in use. <u>Single line working over Up line.</u>
220 Whittlesford Crossovers and Audley End	Up Main BLOCKED	22 35 to 04 00. Track maintenance and signalling work. 45% and 45% m.p. Mechanical equipment in use. <u>Single line working over Down Main line.</u>

MONDAY 18 TO FRIDAY 22 AUGUST

221 Bethnal Green and Hackney Downs	Down Fast BLOCKED	10 15 to 15 00 daily. Construction work (London Fields Station). <u>Isolation of electrical sections 316. Down Trains to travel over Down Suburban line.</u>
---	----------------------	--

SECTION B - TEMPORARY ENGINEERING WORKS - continued

At or between	Lines affected	Remarks
<u>BETHNAL GREEN JN TO KING'S LYNN - continued</u>		
MONDAY 18 TO FRIDAY 22 AUGUST - continued		
222 Cambridge (South) and Coldham Lane Jn	All <u>Between Trains</u>	08 00 to 18 00 daily. Construction work (overhead line). 55½ and 56¾m.p. Mechanical equipment in use.
223 Littleport and Downham Market	Single	08 00 to 16 00 daily. Bridgework (No. 1766) 83m. 23chs. Mechanical equipment in use.
TUESDAY 19 AND WEDNESDAY 20 AUGUST		
224 Bethnal Green (Country End) and Seven Sisters	Down and Up Suburban/ Down and Up BLOCKED	00 30 to 05 00 daily. Track renewal and loading rails 3m. 04chs. Crane in use. <u>Trains to travel over Fast lines and to be diverted via Clapton.</u>
TUESDAY/WEDNESDAY 19/20 AUGUST		
225 Stansted and Bishops Stortford	Up Main BLOCKED	22 30 to 04 55. Track maintenance 33¼ and 32m.p. Mechanical equipment in use. <u>Single line working over Down Main line.</u>
WEDNESDAY 20 AUGUST		
226 Cheshunt Station and Broxbourne Station (Country End)	Down Main BLOCKED	00 01 to 04 15. Track maintenance. Mechanical equipment in use. <u>Single line working over Up Main line.</u>
WEDNESDAY 20 AND THURSDAY 21 AUGUST		
227 Cambridge	Down Goods Loop South and Platforms 2 and 3 BLOCKED	01 30 to 05 30 daily. Track maintenance 55¼ and 55½m.p. Mechanical equipment in use. <u>Trains to travel over other lines. Access available to/from Platform 2.</u>

SECTION B - TEMPORARY ENGINEERING WORKS - continued

At or between	Lines affected	Remarks
---------------	----------------	---------

BETHNAL GREEN JN TO KING'S LYNN - continued

WEDNESDAY/THURSDAY 20/21 AUGUST

228	Bishops Stortford and Stansted	Down Main BLOCKED	22 35 to 05 30. Track maintenance. 32 and 33 $\frac{1}{2}$ m.p. Mechanical equipment in use. <u>Single line working over Up Main line.</u>
-----	--------------------------------------	----------------------	--

WEDNESDAY 20 TO FRIDAY 22 AUGUST

229	Harlow Town and Broxbourne Jn.	Up BLOCKED	23 05 Wed and Thu to 04 30 Thu and Fri. Track maintenance. Mechanical equipment in use. <u>Single line working over Down line.</u>
230	Ely North Jn and Littleport	Down and Up BLOCKED	23 00 Wed and Thu to 05 00 Thu and Fri. Track maintenance. 72 and 76m.p. Mechanical equipment in use.

HACKNEY DOWNS NORTH JN TO ENFIELD TOWN

TUESDAY 19 AND WEDNESDAY 20 AUGUST

231	Bethnal Green (Country End) and Seven Sisters	Down and Up Suburban/ Down and Up BLOCKED	00 30 to 05 00 daily. Track renewal, track maintenance and loading rails. 3m. 04chs. Crane in use. <u>Trains to travel over Fast lines and to be diverted via Clapton.</u>
232	Seven Sisters and Enfield Town	All BLOCKED	00 30 to 05 00 daily. Overhead line work. Mechanical equipment in use. <u>Trains diverted via Clapton.</u>

TUESDAY 19 TO FRIDAY 22 AUGUST

233	Hackney Downs and Enfield Town	All BLOCKED to Electric trains	00 30 to 05 00 daily. In connection with engineering work. <u>Isolation of electrical Sections 401, 402, 403 and 404. Trains diverted via Clapton.</u>
-----	--------------------------------------	--------------------------------------	---

THURSDAY 21 AND FRIDAY 22 AUGUST

234	Seven Sisters and Enfield Town	All BLOCKED	00 30 to 05 00 daily. Overhead line work and loading rails. Crane and mechanical equipment in use. <u>Trains diverted via Clapton.</u>
-----	--------------------------------------	----------------	---

SECTION B - TEMPORARY ENGINEERING WORKS - continued

<u>At or between</u>	<u>Lines affected</u>	<u>Remarks</u>
<u>BURY STREET JN TO CHESHUNT</u>		
TUESDAY 19 TO FRIDAY 22 AUGUST		
235 Bury Street Jn and Cheshunt Jn	Down and Up BLOCKED to electric trains	00 30 to 05 00 daily. In connection with engineering work. Isolation of electrical Sections 405A, 406A.

CLAPTON JN TO CHINGFORD

SATURDAY 16 AUGUST

236 Clapton Jn. and Chingford	Down and Up BLOCKED	00 55 to 04 30. Overhead line work. Mechanical equipment in use. <u>Isolation of electrical sections 409 and 410.</u>
-------------------------------	------------------------	--

SUNDAY 17 AUGUST

237 Clapton Jn. and Chingford	Down and Up BLOCKED	01 00 to 06 30. Track maintenance and track renewal.
-------------------------------	------------------------	--

BROXBOURNE JN TO HERTFORD EAST

UNTIL FURTHER NOTICE

238 Rye House and St. Margarets	Down and Up	08 00 to 18 00. Bridgework (No. 2035A). 19m. 66chs. Mechanical equipment in use. (85/60)
---------------------------------	-------------	---

SUNDAY 17 AUGUST

239 Broxbourne Jn and Hertford East	All BLOCKED	00 30 to 06 30. Bridgework (No. 2035A) 19m. 66chs. Mechanical equipment in use. <u>Isolation of electrical sections 434 and 435.</u>
-------------------------------------	----------------	--

MONDAY 18 AUGUST

240 Broxbourne Jn and St. Margarets	Down and Up BLOCKED to electric trains	00 40 to 03 50. In connection with overhead line work between Brimsdown and Cheshunt Station. <u>Isolation of electrical sections 414.</u>
-------------------------------------	--	--

SECTION B - TEMPORARY ENGINEERING WORKS - continued

At or between	Lines affected	Remarks
---------------	----------------	---------

CHIPPENHAM JN TO ELY DOCK JN

UNTIL FURTHER NOTICE

248	Soham and Chippenham Jn	Up <u>Between Trains</u>	07 00 to 19 00. Earthwork. 3m.p. Mechanical equipment in use. (86/17)
-----	----------------------------	-----------------------------	---

SATURDAY/SUNDAY 16/17 AUGUST

249	Chippenham Jn and Soham	Down and Up BLOCKED	22 00 to 14 00. Track renewal 3m.p. Crane and mechanical equipment in use. <u>Possession to be given up for</u> <u>passage of 1M74 07 20 Harwich</u> <u>Parkeston Quay to Manchester</u> <u>Piccadilly over Down line.</u>
-----	----------------------------	------------------------	---

ELY NORTH JN TO PETERBOROUGH, CRESCENT JN

SATURDAY/SUNDAY 16/17 AUGUST

250	March East Jn and Whittlesea	Up BLOCKED Down BLOCKED	23 30 to 08 00)Track renewal and track)maintenance. 89 and 23 30 to 16 00)94 $\frac{3}{4}$ m.p. Mechanical)equipment in use.)08 00 to 16 00 Sun) <u>Single line</u>) <u>working over Up</u>) <u>line.</u>
-----	---------------------------------	----------------------------------	--

251	Whittlesea and Crescent Jn	Down and Up BLOCKED	23 30 to 08 00. Track maintenance 94 $\frac{3}{4}$ and 100 $\frac{1}{2}$ m.p. Mechanical equipment in use.
-----	-------------------------------	------------------------	--

TUESDAY 19 AUGUST

252	March South Jn and Manea	Up BLOCKED	00 01 to 05 00. Track maintenance 81 $\frac{1}{2}$ and 81 $\frac{1}{2}$ m.p. Mechanical equipment in use. <u>Single line working over</u> <u>Down line.</u>
-----	-----------------------------	---------------	--

SECTION B - TEMPORARY ENGINEERING WORKS - continued

At or between	Lines affected	Remarks
<u>ELY NORTH JN TO TROWSE LOWER JN</u>		
UNTIL FURTHER NOTICE		
253 Wymondham and Hethersett	Down and Up <u>Between Trains</u>	07 30 to 18 00. Bridgework, earthwork and construction work. 115m. 65chs. and 117m. 69chs. Cranes and mechanical equipment in use. (86/18)
254 Wymondham and Trowse Lower Jn	Down and Up	07 30 to 16 00. Signalling work. (85/24)
255 Hethersett and Trowse Lower Jn	Down and Up	08 00 to 16 00. Bridgework (Nos. 1638 and 349). 121m. 17chs. and 122m. 32chs. (85/62)
256 Hethersett and Trowse Lower Jn	Down and Up	07 30 to 16 00. Bridgework (Nos 1640 and 1640A) 121½m.p. <u>From 07 30 Monday 18 August.</u>

SATURDAY/SUNDAY 16/17 AUGUST

257 Brandon and Thetford	Up BLOCKED Down BLOCKED	22 00 to 08 15)Track maintenance,)track renewal and 22 30 to 16 00)loading materials.)Mechanical equipment)in use. <u>22 00 Sat to</u>) <u>08 15 Possession to</u>) <u>be given up for passage</u>) <u>of 1P04 02 10 Liverpool</u>) <u>Street to Yarmouth</u>) <u>over Up line under</u>) <u>single line working.</u>) <u>08 15 to 16 00 Sun</u>) <u>Single line working</u>) <u>over Up line.</u>
258 Hethersett and Trowse Lower Jn	Down and Up BLOCKED	22 00 to 07 30. Bridgework (Nos 1640 and 1640A), track maintenance and unloading materials 121½m.p.

MONDAY 18 TO FRIDAY 22 AUGUST

259 Lakenheath and Brandon	Down	08 00 to 16 00 daily. Track maintenance. 82½ and 85m.p.
----------------------------	------	---

SECTION B - TEMPORARY ENGINEERING WORKS - continued

<u>At or between</u>	<u>Lines affected</u>	<u>Remarks</u>
----------------------	-----------------------	----------------

ELY NORTH JN TO TROWSE LOWER JN - continued

MONDAY 18 TO SATURDAY 23 AUGUST

260	Brandon and Thetford	Down and Up BLOCKED	23 45 Mon to Fri to 06 00 Tue to Sat. Track maintenance, track renewal and unloading rails. Crane and mechanical equipment in use.
261	Harling Road and Eccles Road	Down and Up	08 00 to 16 00 daily. Track maintenance. 101½ and 104m.p.

WEDNESDAY 20 TO FRIDAY 22 AUGUST

262	Ely North Jn. and Lakenheath	Down BLOCKED	23 00 Wed and Thu to 06 00 Thu and Fri
		Up BLOCKED	00 10 to 06 00 Thu and Fri
)Track maintenance)72 and 81½m.p.)Mechanical)equipment in)use.

WYMONDHAM TO NORTH ELMHAM

UNTIL FURTHER NOTICE

263	Wymondham and North Elmham	Single	08 00 to 16 00. Trimming lineside vegetation. ¼ and 6m.p. Mechanical equipment in use. (85/31)
-----	----------------------------	--------	---

FENCHURCH STREET TO SHOEBURYNESS

UNTIL FURTHER NOTICE

264	Fenchurch Street Station	All	Construction/demolition work. Mechanical equipment in use. (84/38)
265	Fenchurch Street and Christian Street Jn	Down and Up Slow	07 00 to 18 00. In connection with engineering work. (85/20)
266	Fenchurch Street and Stepney East	All	07 30 to 18 30. Construction work. Mechanical equipment in use. (85/27)

SECTION B - TEMPORARY ENGINEERING WORKS - continued

At or between	Lines affected	Remarks
---------------	----------------	---------

FENCHURCH STREET TO SHOEBURYNESS - continued

UNTIL FURTHER NOTICE - continued

267	Fenchurch Street and Gas Factory Jn	All	08 00 to 17 00. Signalling work. (86/1)
268	East Ham	Down and Up	Construction work. Mechanical equipment in use. (83/51)
269	East Ham and Barking (London End)	Down and Up	Erecting scaffolding in connection with bridge No. 66B. (85/8)
270	Leigh-on-Sea and Benfleet	Up	Sea wall work. (85/34)
271	Leigh-on-Sea	Down	09 00 to 16 00. Demolition work. Mechanical equipment in use. (85/60)
272	Westcliff-on-Sea	Down	09 00 to 16 00. Demolition work. Mechanical equipment in use. (85/60)

MONDAY 11 TO SATURDAY 16 AUGUST

273	Fenchurch Street	All BLOCKED	21 15 Mon to Fri to 06 00 Tue to Sat. Construction work. Mechanical equipment in use.
274	East Ham (London End) and Barking Station (London End)	Down and Up Main BLOCKED	21 15 Mon to Fri to 05 15 Tue to Sat. Bridgework (No. 66B). Crane and mechanical equipment in use. <u>Isolation of electrical sections 510A, 511E.</u>

SATURDAY 16 AUGUST

275	Fenchurch St	Platform 3 and 4 BLOCKED	07 00 to 16 30. Construction work. Mechanical equipment in use.
276	Barking and Upminster (Country End)	Down and Up Main BLOCKED	01 00 to 04 15. Overhead line work. <u>Isolation of electrical sections 514 and 515. Trains diverted via Grays.</u>

SECTION B - TEMPORARY ENGINEERING WORKS - continued

<u>At or between</u>	<u>Lines affected</u>	<u>Remarks</u>
----------------------	-----------------------	----------------

FENCHURCH STREET TO SHOEBURYNNESS - continued

SUNDAY 17 AUGUST

277 Barking	Down and Up Tilbury (Platforms 7 and 8) and Up Goods Loop BLOCKED	00 50 to 06 15. Overhead line work (conversion). <u>Isolation of electrical sections 512D, 513ABCD. Possession to be given up for passage of Engineers' trains.</u>
278 Upminster and Pitsea	Down and Up BLOCKED	01 15 to 22 00. Overhead line work, track maintenance, painting Basildon Station and track renewal. Crane and mechanical equipment in use. <u>Isolation of electrical sections 517, 518, 519 and 520. Trains diverted via Grays.</u>
279 Southend Central and Shoeburyness	Down BLOCKED	01 45 to 06 30. Track maintenance.

MONDAY 18 AUGUST

280 Christian Street Jn and East Ham (London End)	Down and Up BLOCKED	00 01 to 06 00. Overhead line work. <u>Isolation of sections 505, 506, 507 and 508.</u>
--	------------------------	--

MONDAY 18 TO FRIDAY 22 AUGUST

281 Fenchurch Street Station	Platform 3 and 4 BLOCKED	10 25 to 15 45 daily. Construction work. Mechanical equipment in use. <u>Isolation of electrical sections 501D, 502A. Trains to be replatformed as necessary.</u>
282 Fenchurch Street and East Ham C.S. (London End)	All BLOCKED	23 59 Mon to Thu to 05 30 Tue to Fri. Track maintenance. Mechanical equipment in use.

MONDAY 18 TO SATURDAY 23 AUGUST

283 Fenchurch St.	All BLOCKED	21 15 Mon to Fri to 06 00 Tue to Sat. Construction work. Mechanical equipment in use.
-------------------	----------------	---

SECTION B - TEMPORARY ENGINEERING WORKS - continued

At or between	Lines affected	Remarks	
<u>UPPER HOLLOWAY TO BARKING, TILBURY LINE JN WEST</u>			
UNTIL FURTHER NOTICE			
284	Upper Holloway and Crouch Hill Station	Down and Up	Earthwork. 3m. 4lchs. and 3m. 43chs. Mechanical equipment in use. (85/64)
285	Wanstead Park Station	Up	08 00 to 16 00. Platform work. <u>(See Section 'D')</u> . (85/50)
286	Woodgrange Park and Barking Station Jn	Down and Up <u>Between Trains</u>	07 30 to 18 00. Bridgework (No. 6). 12m. 26chs. Crane and mechanical equipment in use. (85/62)
287	Woodgrange Park and Barking Tilbury Line Jn West	Down and Up	Erecting scaffolding in connection with bridge No. 14A. (85/8)
SUNDAY 17 AUGUST			
288	South Tottenham East Jn. and Woodgrange Park Jn.	Down and Up BLOCKED	00 01 to 07 45. Track maintenance and unloading materials. Mechanical equipment in use.
289	Forest Gate Jn and Barking Tilbury Line Jn West	Down and Up BLOCKED to electric trains	00 50 to 18 00. In connection with engineering work. <u>Isolation of electrical sections 512AB, 513EF.</u>
290	Woodgrange Park Jn and Barking Tilbury Line Jn West	Down and Up BLOCKED	00 50 to 06 15. Bridgework (Nos. 6 and 14A). Crane and mechanical equipment in use. <u>Possession to be given up for passage of Engineers' trains.</u>
291	Woodgrange Park Station and Barking Station Jn	Down BLOCKED	08 00 to 18 00. Overhead line work (conversion). <u>Single line working over Up line.</u>

SECTION B - TEMPORARY ENGINEERING WORKS - continued

At or between	Lines affected	Remarks
<u>BARKING, TILBURY LINE JN EAST TO TILBURY RIVERSIDE</u>		
UNTIL FURTHER NOTICE		
292 Dagenham Dock Station	Down and Up	08 00 to 17 00. Construction work. Mechanical equipment in use. (85/14)
293 Rainham Station	Down and Up	08 00 to 17 00. Construction work. Mechanical equipment in use. (85/14)
294 Purfleet Station	Down and Up	09 00 to 16 00. Platform work. Mechanical equipment in use. (85/61)
295 Purfleet and West Thurrock Jn	Down and Up	07 30 to 18 00. Bridgework (No. 94A), 17m. 34chs. Mechanical equipment in use. (85/21)

SATURDAY/SUNDAY 16/17 AUGUST

296 Dagenham Dock and Tilbury Line Jn East	Up Main and Up Goods BLOCKED	23 50 to 07 15. Track maintenance.
--	---------------------------------	------------------------------------

SECTION CSIGNALLING AND PERMANENT WAY ALTERATIONS

- * * Items marked thus will not appear in future issues and a note must be
 * taken of them by all concerned.

DETAILS OF WORK REFERRED TO IN SECTION BSUNDAY 17 AUGUST - THORPE JUNCTION AND NORWICH STATION.Thorpe Junction

Down Main bracket-post colour light signal NO.565 will be replaced by a new straight post signal 60 yards nearer to Norwich Station and on the left-hand side of the line. The associated A.W.S. inductor (permanent magnet) will be repositioned accordingly.

A Banner Repeating signal plated NO.565R will be provided 103 yards before reaching repositioned NO.565 signal.

Norwich Station

The Goods Yard/Carriage Sidings Headshunt line (adjacent to Down Main/Line "W"), will be reinstated in an extended form.

Position light shunting signal NO.1781 will be reinstated in a new position and on the right-hand side of the Headshunt.

The signal routes associated with the above are included in the Description of Signals in Supplementary Signalling Notice No. 144 dated Sunday, 3 August, 1986.

MONDAY 18 AUGUST - BETWEEN REEDHAM JN AND YARMOUTH

W.e.f. 10 00 hours the 30m.p.h. Temporary Speed Restriction on the Single line between 13m. 52chs. and 15 $\frac{1}{2}$ m.p. will become a Permanent Speed Restriction.

A 30m.p.h. Permanent Speed Restriction, applicable to both DOWN and UP trains will then apply on the Single line throughout between 13m. 52chs. and 19m. 24chs. (See Section D).

(24)

SUNDAY 17 AUGUST - LAINDON

The temporary buffer-stops previously provided at the Country end of the Middle (Reversing) line will be removed at 22 00 hrs.

(24)

SECTION C - SIGNALLING AND PERMANENT WAY ALTERATIONS - continuedDETAILS OF WORK ALREADY CARRIED OUTGIDEA PARK

The Engine Shunt Spur at the London end of the Down Siding, has been taken out of use until further notice.

(22)

NEW HALL

The Up Loop has been taken out of use Until Further Notice.

(UFN)

HATFIELD PEVEREL

The facing and trailing crossovers are out of use until further notice.

(UFN)

AUDLEY END LEVEL CROSSING AT 97m 05chs (FORMERLY KNOWN AS ARDLEY END LEVEL CROSSING) - BETWEEN DISS AND TIVETSHALL

The crossing has been converted to an Automatic Half-barrier level crossing. Telephone communication has been provided between the crossing and Diss signalbox.

The barriers are equipped to work automatically when approached in the wrong direction, and for this purpose, a combined St. Andrew's Cross/50 m.p.h. speed restriction sign has been provided applicable to each rail approach in the wrong direction as follows :-

1,089 yards south of the crossing on the Up Main, applicable to the Down (wrong) direction of approach.

974 yards north of Audley End crossing on the Down Main, applicable to the Up (wrong) direction of approach.

Burston Automatic Half-barrier Level Crossing at 97m 42chs

The St. Andrew's Cross/50 m.p.h. speed restriction sign applicable to Burston level crossing, located on the Up Main, approximately 130 yards south of Audley End level crossing has been repositioned to a location immediately north of Audley End level crossing. (This sign is applicable to wrong (Down) direction trains approaching Burston level crossing on the Up Main).

(22)

SECTION C - SIGNALLING AND PERMANENT WAY ALTERATIONS - continuedDETAILS OF WORK ALREADY CARRIED OUT - continuedTROWSE YARD SIGNALBOX

The Down Siding, (adjacent to the Down Main) and the S & T Loading Dock Siding have been taken out of use.

Connections to these Sidings have been secured for through running to/from the Back Road (Loading Dock) Siding.

All associated signals/signal routes have been abolished.

(22)

BETWEEN TROWSE SWING BRIDGE AND THORPE JUNCTION

The Down Main has been realigned between Trowse Swing Bridge and Thorpe Junction. (The new alignment is towards and partly on the alignment of the former Goods Yard Siding/Down Goods line recently removed).

Access to the realigned Down Main at the Trowse Swing Bridge end is via the former Down Main to Goods Yard Siding/Down Goods line facing connection, which has been restored to use.

Trowse Swing Bridge Down Main semaphore Starting Signal applies towards NO 565 signal via the realigned Down Main.

The ground shunting signal, applying set back on the realigned Down Main, at Trowse Swing Bridge has been restored to use and applies towards the Up Main.

Reference should be made to the diagram included in Supplementary Signalling Notice No. 144 (Page 4) dated Sunday 3 August.

(23)

NORWICH STATION AND THORPE JUNCTION (BETWEEN TROWSE SWING BRIDGE AND NORWICH AND BETWEEN THORPE JUNCTION AND WHITLINGHAM JUNCTION)

Reference should be made to Supplementary Signalling Notice No. 144. All concerned should be in possession of a copy of this notice.

(22)

SOUTHMINSTER

A 15 m.p.h. Permanent Speed Restriction applicable to Down and Up trains has been IMPOSED on the SINGLE line in the vicinity of Southminster station between 45m. 23chs. and 45m. 42chs. (end of line). (See Section 'D').

(23)

SECTION C - SIGNALLING AND PERMANENT WAY ALTERATIONS - continued

DETAILS OF WORK ALREADY CARRIED OUT - continued

WOODBIDGE

The Up direction flashing White Light/Point Indication Light adjacent to Sun Wharf/Lime Kiln level crossings has been repositioned closer to the Single line at a distance of 5 yards from Sun Wharf Level Crossing.

(23)

CAMBRIDGE UP YARD

Sidings Nos. 1 to 11 inc. have been shortened by 80 yards.

(23)

* * TILBURY FREIGHTLINER DEPOT

*

The hand spring-points in Seabrook Sidings are now detected in the normal position and a Points Indicator situated adjacent to the points displays YELLOW when the points are normal.

The Acceptance Plunger (from Grays Signal Box direction) has been resited in the Shunters Cabin.

(The telephone adjacent to the spring points remains in its former position).

(21)

SECTION D

GENERAL INSTRUCTIONS AND NOTICES

A thick vertical line denotes new or amended items.

- * * Items marked thus will not appear in future issues and a note must be
- * taken of them by all concerned.

ALTERATION TO WORKING MANUAL FOR RAIL STAFF (B.R. 30054)

PART 2 : GREEN PAGES

C. OVERHANGING LOADS

1. Bolster and Other Wagons

Clause C1/6(a) should read :-

Runner Wagons must have a tare weight of not less than 10.5 tonnes.

(UFN)

SECTION D - GENERAL INSTRUCTIONS AND NOTICES - continued

EASTERN REGION SECTIONAL APPENDIX (SOUTHERN AREA)

TABLE A : DETAILS OF RUNNING LINES

Running Lines and Signalling System	Location	M. Ch.	Permanent Speed Restrictions		Remarks
			Down m.p.h.	Up m.p.h.	
<u>LIVERPOOL STREET TO NORWICH</u>					
<u>Page 60</u>					
<u>Delete:-</u>	Ardley End LC	97 00			
<u>Substitute :-</u>	Audley End (Norfolk) LC (AHB-X)	97 05	X50	X50	<u>Approaching level crossing in wrong direction.</u>
					(10.SD)
<u>WICKFORD JN. TO SOUTHMINSTER</u>					
<u>Page 68 (Page 20, SD.PON)</u>					
At Southminster					
<u>Add:-</u>			15	15	<u>45m. 23chs. and 45m. 42chs.</u>
					(10.SD)

SE-53

SECTION D - GENERAL INSTRUCTIONS AND NOTICES - continued

EASTERN REGION SECTIONAL APPENDIX (SOUTHERN AREA) - continued

Running Lines and Signalling System	Location	M. Ch.	Permanent Speed Restrictions		Remarks
			Down m.p.h.	Up m.p.h.	
<p><u>NORWICH TO LOWESTOFT</u></p> <p>Page 78 (Page A44, SD PON)</p> <p>Delete all details between Norwich Thorpe Jn and Whitlingham Jn and substitute :-</p>					
	Norwich	0 00	15	All lines. 0m.p. and 0m. 38chs.	
	Norwich (NO)	0 23			Norwich (NO) signal box area between Norwich and Crown Point.
	Thorpe Jn (See page 61)	0 29			

SE-54

SECTION D - GENERAL INSTRUCTIONS AND NOTICES - continued

EASTERN REGION SECTIONAL APPENDIX (SOUTHERN AREA) - continued

Running Lines and Signalling System	Location	M. Ch.	Permanent Speed Restrictions		Remarks
			Down m.p.h.	Up m.p.h.	
<p><u>NORWICH TO LOWESTOFT - continued</u></p> <p><u>Page 78 (Page A44, SD PON) - continued</u></p> <p><u>Delete</u> all details between Norwich Thorpe Jn and Whitlingham Jn and <u>substitute - continued</u> :-</p>					
<p>Line B</p> <p>Line A</p>		0 35			
	Crown Point	0 60			
	Whitlingham Jn (WH) (See page 79)	1 69	25	15	All lines. 0m. 38chs. and 0m.p.
				To Cromer line.	

SE-55

SECTION D - GENERAL INSTRUCTIONS AND NOTICES - continued

EASTERN REGION SECTIONAL APPENDIX (SOUTHERN AREA) - continued

Running Lines and Signalling System	Location	M. Ch.	Permanent Speed Restrictions		Remarks
			Down m.p.h.	Up m.p.h.	
<p><u>Page 81</u></p> <p>At Berney Arms</p> <p><u>Delete :-</u> <u>Substitute :-</u></p>			<p><u>30</u></p> <p><u>30</u></p>	<p><u>30</u></p> <p><u>30</u></p>	<p><u>15³/m.p. and 19m. 24chs.</u> <u>13m. 52chs. and 19m. 24chs.</u></p> <p>(w.e.f. 10 00 hours Monday 18 August) (10.SD)</p>

SE-56

SECTION D - GENERAL INSTRUCTIONS AND NOTICES - continuedEASTERN REGION SECTION APPENDIX (SOUTHERN AREA) - continuedOTHER GENERAL INSTRUCTIONSPage 297Add :- DOCKLANDS LIGHT RAILWAY LINE BETWEEN BOW JN AND STRATFORD STATION
(ADJACENT TO THE B.R. UP ELECTRIC LINE)

B.R. staff must observe the provisions of the previous instructions on pages 294 to 297 headed, "Instructions to Traincrews Working other than D.C. Electric trains and other staff concerned working over or in the vicinity of D.C. Electrified lines", except that reference to Electrical Control Operator should be read as Controller and Supervisor at Poplar Control Centre, who can be contacted via the Signaller at Bow Jn or on British Telecom 538 3440.

The Docklands Light Railway when fully operational will work automatically without lineside signals, using Driverless trains which will approach in either direction travelling at a maximum speed of 50m.p.h. Each train will convey a member of Docklands Light Railway staff called a "Train Captain".

Docklands trains will not sound a warning to persons on or near the line, etc. and B.R. Staff must not, therefore, except in emergency go onto the Docklands Light Railway. Posts are provided in the 10 Foot between the Up Electric line and the Docklands line to identify the point beyond which staff must not proceed. When staff stand clear of the Up Electric line they must align themselves between the posts.

In the vicinity of the Bow Junction signal box and overbridge 609 (Fairfield Road), Staff must not, except in emergency, proceed beyond the fence between the B.R. and Docklands line. If unavoidable circumstances compel staff to remain between the B.R. and Docklands lines when trains pass, they must lay down against the B.R. side of the fence. It is important that this instruction is observed as the collector shoes of Docklands Light Railway trains will pass in close proximity to the Docklands side of the fence.

If an emergency/mishap occurs on B.R. lines requiring the stopping of trains on the Docklands Light Railway, standard B.R. protection arrangements must be observed and advice given to the Poplar Control Centre by the quickest available means. It should be noted that the placing of a Track Circuit Operating Clip on the Docklands line will stop a train which is in automatic mode.

(10.SD)

SECTION D - GENERAL INSTRUCTIONS AND NOTICES - continuedMISCELLANEOUS NOTICESG.E. ELECTRIFIED LINES
RESIDUAL VOLTAGE TESTING ON OVERHEAD LINE EQUIPMENT

Commencing Sunday 10 August 1986 until Saturday 23 August 1986, from 23 00 hrs. - 06 00 hrs. (Sat. night/Sun. 16/17 August excluded), R.M. & E.E. Department test section are to conduct investigations to measure the voltage magnitude present on the overhead line equipment during a series of simulated emergency isolations.

The tests will embrace all electrified lines; Fenchurch Street to Shoeburyness, Liverpool Street to Clacton/Walton, Shenfield to Southend, Liverpool Street to Bishops Stortford/Hertford East and branches.

Electrical sections between certain neutral sections will be de-energised for periods of 3-5 minutes duration in the area under test. Whilst it is desirable to attain test conditions without the presence of electrical rolling stock inside the test area, if this is unavoidable, power will be restored to each electrical section concerned upon the completion of voltage measurements for that section.

(22)

WORKING OF CLASS 313 AND CLASS 416 ELECTRIC MULTIPLE UNIT
TRAINS BETWEEN DALSTON WESTERN JN AND STRATFORD MARKETClass 313 Electric Multiple Units

These units must only work between Navarino Road Jn and Stratford Market stabling sidings when either the Graham Road Curve route to Liverpool Street is not available, or when the pantographs have failed to rise. When operating between Dalston Kingsland and Stratford Market stabling sidings and return in the D.C. mode, Drivers must not advance the controller beyond Notch 2.

THESE UNITS MUST NOT RUN BEYOND STRATFORD MARKET TOWARDS NORTH WOOLWICH.

Class 416 Electric Multiple Units

Not more than two Class 416 units may be coupled together.

When two Class 416 units are running in multiple between Dalston Western Jn and Stratford Market, including the stabling sidings or return, Drivers must not advance the controller beyond Notch 2.

(UFN)

BETHNAL GREEN STATION

Until Further Notice, whilst demolition work is taking place, Drivers of 4-Car EMU trains must stop their trains at the temporary stop boards provided.

(UFN)

SECTION D - GENERAL INSTRUCTIONS AND NOTICES - continuedMISCELLANEOUS NOTICES - continuedDALSTON (KINGSLAND) STATION

The Down and Up platforms have been temporarily shortened at the Stratford end by 25 yards and only accommodate two coaches. Drivers of Down trains booked to stop at this station must bring their train to a stand at signal DW14/16. Drivers of Up trains booked to stop at this station must bring their train to a stand at the temporary stop board which has been provided adjacent to the footbridge.

(LM) (UFN)

HARWICH PARKESTON QUAY STATION

Until Further Notice, reconstruction work on Platform 2 will create hazards for passengers, including sub-standard surfaces and larger than normal gaps between the platform and train.

Special warning notices are to be exhibited and best use made of on-train and station announcing facilities to warn the Public of the danger.

(UFN)

SAWBRIDGEWORTH STATION

The stop board on the Up platform has been temporarily moved 9 yards towards the Country side of its former position.

(UFN)

WANSTEAD PARK STATION

Whilst platform repairs are taking place, Drivers of Up trains must stop their trains at the temporary stop boards provided.

(UFN)

REPAIRS IN MOTIVE POWER DEPOTS, CARRIAGE SHEDS, WAGON REPAIR SHEDS AND WAREHOUSES

In connection with work being carried out at the undermentioned places, scaffolding or projections may be provided or unusual excavations may be made in the ground:-

Location	Nature of Work	Duration	Commencing date
Liverpool Street, Locomotive Holding Sidings.	Earthwork.	Continuously. Until Further Notice.	-

SECTION D - GENERAL INSTRUCTIONS AND NOTICES - continuedMISCELLANEOUS NOTICES - continuedREPAIRS IN MOTIVE POWER DEPOTS, CARRIAGE SHEDS, WAGON REPAIR SHEDS AND WAREHOUSES - continued

In connection with work being carried out at the undermentioned places, scaffolding or projections may be provided or unusual excavations may be made in the ground:-

Location	Nature of Work	Duration	Commencing date
Stratford T.M.D. All lines.	Repairs to Motive Power Depot. Cranes and mechanical equipment in use.	Continuously. Until Further Notice.	-
Ilford EMU Depot, Nos. 19 and 20 Roads.	Drainage.	08 00 to 17 00 daily. Until Further Notice.	-
Ilford EMU Depot, Carriage Washer Roads BLOCKED	Renewal of carriage washer plant. <u>Isolation of electrical sections 361R.</u>	Continuously. Until Further Notice.	-
Ilford EMU Depot, Nos. 6 to 16 inc. Sidings BLOCKED to electric trains	In connection with construction work. <u>Isolation of electrical sections 361GH.</u>	11 00 to 13 00 daily.	<u>From Monday 18 until Friday 22 August.</u>
Norwich Crown Point T & R.S. M.D., All lines BLOCKED	Construction work (overhead line) and track maintenance. Mechanical equipment in use. <u>Possession to be given up for passage of trains.</u>	08 00 to 17 00 daily. Until further notice.	-
East Ham EMU Depot, All lines.	Shed reconstruction.	Continuously. Until Further Notice.	-
East Ham EMU Depot, Washer Road BLOCKED	Repairs to washer plant. <u>Isolation of electrical sections 509A.</u>	Continuously. Until Further Notice.	-

SECTION D - GENERAL INSTRUCTIONS AND NOTICES - continuedMISCELLANEOUS NOTICES - continuedREPAIRS IN MOTIVE POWER DEPOTS, CARRIAGE SHEDS, WAGON REPAIR SHEDS AND WAREHOUSES - continued

In connection with work being carried out at the undermentioned places, scaffolding or projections may be provided or unusual excavations may be made in the ground:-

Location	Nature of Work	Duration	Commencing date
East Ham EMU Depot, Nos. 17, 18, 19 and 20 Sidings BLOCKED to electric trains	In connection with engineering work between East Ham and Barking. Crane and mechanical equipment in use. <u>Isolation of electrical sections 509J.</u>	00 01 to 06 15 <u>Sunday 17 August.</u>	-
East Ham EMU Depot, Nos. 17, 18, 19 and 20 Sidings BLOCKED to electric trains	In connection with engineering work between East Ham and Barking. Crane and mechanical equipment in use. <u>Isolation of electrical sections 509J.</u>	21 15 Mon to Fri to 05 15 Tue to Sat.	<u>From Monday 18 until Saturday 23 August.</u>
Shoeburyness CSD, No. 16 Road BLOCKED	Cleaning Admin. Block Windows. <u>Isolation of electrical sections 529A.</u>	10 00 to 12 00. <u>Thursday 21 August.</u>	-

MP.32/SE
YORK
7 AUGUST, 1986

C. McKEEVER
Regional Operations Manager

BRITISH RAIL
EASTERN REGION

SE

25

WEEKLY OPERATING NOTICE

CONTAINING

TEMPORARY SPEED RESTRICTIONS

TEMPORARY ENGINEERING WORKS

SIGNALLING AND
PERMANENT WAY ALTERATIONS

GENERAL INSTRUCTIONS AND NOTICES

SATURDAY 13 SEPTEMBER

TO

FRIDAY 19 SEPTEMBER 1986

INCLUSIVE

Trainmen must pay particular attention to works contained in this notice and keep a good look-out for handsignals which may be exhibited in accordance with the Rules and Regulations.

Work at places other than those mentioned may be in progress and Drivers must be on the look-out and be prepared to stop or run at reduced speed when, and where, handsignals may be exhibited.

SECTION A

TEMPORARY SPEED RESTRICTIONS

(Until further notice unless otherwise specified)

Warning Boards and Indicators provided unless otherwise shown.

† Indicates that the Warning Boards and Indicators will be moved as the work progresses. Where two speeds are shown for a restriction e.g. 20 the Rule 40

Book, Section U, Clause 1.2 applies.

Location	Lines affected		Mileage		Restr- iction m.p.h.	Remarks
			M. Ch.	M. Ch.		
<u>LIVERPOOL STREET TO NORWICH</u>						
1 Bow Jn and Bethnal Green Station Jn	-	Up Main	1 70	1 60	30	Trackwork. (86/24)
2 Ilford Car Sheds and Goodmayes Station	Down Main	-	8 37	8 55	20	Trackwork. <u>Warning board also provided on Down Electric line at 7m. 72chs.</u> (86/23)
3 Goodmayes Station and Ilford Car Sheds	-	Up Main	8 55	8 37	20	Trackwork. <u>Warning board also provided on Up Electric line at 9m. 23chs.</u> (86/23)
4 Romford and Gidea Park Station	Down Electric	Up Electric	12 15	12 48	20	Trackwork. (86/24)
5 Harold Wood and Brentwood	Down Main	-	15 02	15 42	<u>20</u> 40	Condition of track. (85/61)
6 Brentwood and Ingatestone	Down Main	-	19 65	20 33	50	Condition of track. (86/14)

SECTION A - TEMPORARY SPEED RESTRICTIONS - continued

Location	Lines affected		Mileage		Restr- iction	m.p.h.	Remarks
			at M.	or between Ch. M. Ch.			
<u>LIVERPOOL STREET TO NORWICH - continued</u>							
7 Chelmsford and New Hall G.F.	Down	-	30 50	30 65	50	Condition of track. (86/12)	
8 Hatfield Peverel - and New Hall		Up	33 26	33 21	40	Earthwork. <u>From 09 00</u> <u>Monday 15</u> <u>until 14 00</u> <u>Friday 19</u> <u>September.</u>	
9 New Hall G.F. and Hatfield Peverel	Down	-	34 50 †	34 70	40	Trackwork. (86/22) <u>Until 10 00</u> <u>Monday 15</u> <u>September.</u>	
10 New Hall G.F. and Witham	Down	-	34 70	38 40	60	Trackwork. (86/22) <u>Until 10 00</u> <u>Monday 15</u> <u>September.</u>	
11 New Hall G.F. and Hatfield Peverel	Down	-	34 50 †	35 20	40	Trackwork. (86/25) <u>From 10 00</u> <u>Monday 15</u> <u>September.</u>	
12 New Hall G.F. and Witham	Down	-	35 20	38 40	60	Trackwork. (86/25) <u>From 10 00</u> <u>Monday 15</u> <u>September.</u>	
13 Church Street LC - and Witham		Up	39 16 †	38 55	20	Earthwork. (86/19) <u>Until 09 00</u> <u>Monday 15</u> <u>September.</u>	
14 Kelvedon	-	Up	42 25	42 10	<u>50</u> 80	Condition of track. (86/7)	

SECTION A - TEMPORARY SPEED RESTRICTIONS - continued

Location	Lines affected		Mileage		Restr- iction	Remarks
			M. Ch.	M. Ch.		
<u>LIVERPOOL STREET TO NORWICH - continued</u>						
15 Long Green LC and Marks Tey Jn	Down	-	46 36	46 55	20	Earthwork. (86/23)
16 Marks Tey Jn and Long Green LC	-	Up	46 55	46 36	30	Earthwork. <u>From 07 00</u> <u>until 16 00</u> <u>Sunday 14</u> <u>September.</u>
<u>SHENFIELD JN TO SOUTHEND VICTORIA</u>						
17 Billericay and Wickford Station	Down	-	26 10	26 44	40	Condition of track. (86/14)
18 Wick Lane LC and Rayleigh	Down	-	31 35	31 75	40	Condition of embankment. (84/41)
<u>WICKFORD JN TO SOUTHMINSTER</u>						
19 Althorne LC and Burnham-on- Crouch	Single		41 10 †	42 10	20	Trackwork. (85/45)
<u>MANNINGTREE SOUTH JN TO HARWICH</u>						
20 Bradfield LC and Wrabness	Down	-	63 37	63 39	40	Earthwork. (85/55)
21 Parkeston Goods Jn and Wrabness	-	Up	66 70	66 10	<u>30</u> 50	Condition of track. (86/3)
<u>NORWICH TO LOWESTOFT</u>						
22 Thorpe Jn and Whitlingham Jn	Down	Up	0 36	0 44	20	Trackwork. (85/20)

SECTION A - TEMPORARY SPEED RESTRICTIONS - continued

Location	Lines affected	Mileage		Restr- iction m.p.h.	Remarks
		at M.	or between Ch. M. Ch.		
<u>BETHNAL GREEN JN TO KING'S LYNN</u>					
23 Cambridge Heath	Down Suburban	Up Suburban	1 57	1 67	20 Platform work. (86/24)
24 Brimsdown and Waltham Cross	Down	Up	11 54	12 12	20 Trackwork. (86/11)
25 Slipe Lane LC and Cheshunt Station	-	Up	15 55	15 35	50 Condition of track. (86/4)
26 Broxbourne Jn and Roydon	Down	Up	19 43 †	20 05	20 Trackwork. (86/19)
27 Sawbridgeworth and Harlow Mill	-	Up	24 76	24 70	60 Condition of track. (86/16)
28 Newport and Elsenham	-	Up	38 34	38 30	20 Bridgework (No. 1505). (86/24) <u>Until 15 00</u> <u>Wednesday 17</u> <u>September.</u>
29 Whittlesford Station	Down Main	-	49 00	49 10	40 Platform work. (86/21)
30 Chesterton Jn and Milton Fen LC	Down	Up	58 63	58 67	20 Bridgework (No. 1550B). (86/24)
<u>COLDHAM LANE JN TO HAUGHLEY JN</u>					
31 Bury St. Edmunds and Thurston	Down	-	31 20	31 50	40 Trackwork. (86/18)
32 Elmswell and Haughley Jn	Down	-	37 15 †	38 00	20 Trackwork. (86/22)

SECTION A - TEMPORARY SPEED RESTRICTIONS - continued

Location	Lines affected	Mileage at or between				Restr- iction m.p.h.	Remarks
		M.	Ch.	M.	Ch.		
<u>ELY NORTH JN TO PETERBOROUGH, CRESCENT JN</u>							
33	Third Drove LC and Welney Road LC	Down	Up	78 00	78 18	20	Condition of track. (86/21)
34	Third Drove LC and Welney Road LC	Down	Up	78 42	78 60	20	Condition of track. (86/21)
35	March East Jn and Badgeney Road LC	-	Up Main	85 40	85 29	20	Trackwork. (85/54) <u>Warning board positioned at signal ME.45. Additional warning board provided on the March East Jn to Wisbech line, positioned at signal ME.52.</u>
36	Three Horse Shoes No. 3 LC	Down	Up	90 74	90 78	<u>20</u> 50	Condition of track. (86/24)

Warning board at 100m. 23chs. (on the Down line) applies only to trains proceeding over the Two-Way Goods line to Fly Ash Inspection Siding connection at Peterborough Station (North).

ELY NORTH JN TO TROWSE LOWER JN

37	Eaton LC and Trowse Lower Jn	Down	Up	121 60	121 64	20	Bridgework (Nos. 1640 and 1640A). (86/23)
----	---------------------------------	------	----	--------	--------	----	--

UPPER HOLLOWAY TO BARKING, TILBURY LINE JN WEST

38	South Tottenham East Jn and Black Horse Road	Down	-	6 45	6 57	20	Condition of track. (85/18)
----	--	------	---	------	------	----	-----------------------------------

SECTION A - TEMPORARY SPEED RESTRICTIONS - continued

Location	Lines affected		Mileage		Restr- iction	Remarks
			at or between M. Ch. M.	Ch. m.p.h.		
<u>BARKING, TILBURY LINE JN EAST TO TILBURY RIVERSIDE</u>						
39 Grays and Tilbury Town	Down	-	20 35	20 65	30	Trackwork. (86/23)
40 Tilbury Town and Grays	-	Up	20 65	20 35	20	Trackwork. (86/23)
<u>TILBURY RIVERSIDE TO PITSEA</u>						
41 Stanford-le- Hope and Gardners LC	Down	-	30 11	30 60	40	Condition of track. (86/1)

SECTION B

TEMPORARY ENGINEERING WORKS

At or between	Lines affected	Remarks
<u>LIVERPOOL STREET TO NORWICH</u>		
UNTIL FURTHER NOTICE		
42	Liverpool Street Station Platforms 1 to 10 Inc.	Repairs to station roof. Mechanical equipment in use. (84/41)
43	Liverpool Street Station Platforms 1 to 18 inc.	Cleaning track. (85/21)
44	Liverpool Street Station Platforms 8, 10 and 11 to 18 inc.	Platform work and construction work. Mechanical equipment in use. (86/21)
45	Bethnal Green Station Down Main and Down and Up Suburban	08 00 to 16 00. Demolition work. (<u>See Section 'D'</u>). (85/41)
46	Bethnal Green and Bow Jn All	Signalling work. <u>From 08 00 Saturday 13 September.</u> (86/25)
47	Stratford and Bow Jn Up Electric	07 30 to 18 00. Construction work. Mechanical equipment in use. (85/62)
48	Forest Gate Jn and Ilford All	07 00 to 18 00. Bridgework (No. 75A), 7m. 08chs. Mechanical equipment in use. (85/20)
49	Ilford Station All	08 00 to 17 00. Repairs to station roof and painting station. (86/2)
50	Romford Jn and Gidea Park All	Bridgework (No. 102B). 12m. 48chs. Crane and mechanical equipment in use. (85/54)
51	Ingatestone and Chelmsford Down and Up	07 30 to 18 00. Construction of bridge (No. 143A) 26m. 5lchs. Mechanical equipment in use. (84/35)
52	Chelmsford and Hatfield Peverel Down and Up	07 30 to 16 00. Earthwork 35m. 53chs. (85/27)
53	Colchester Jn and Ardleigh LC Down	08 00 to 17 00. Earthwork and formation renewal. 52m. 25chs. and 53m. 75chs. Mechanical equipment in use. (85/41)

SECTION B - TEMPORARY ENGINEERING WORKS - continued

At or between	Lines affected	Remarks
<u>LIVERPOOL STREET TO NORWICH - continued</u>		
UNTIL FURTHER NOTICE - continued		
54 Manningtree North Jn and Bentley LC	Down and Up <u>Between Trains</u>	07 00 to 18 00. Tree felling, bridgework (No. 229) and earthwork. 60m. 06chs. and 61m. 06chs. Crane and mechanical equipment in use. (85/15)
55 Ipswich Goods Jn and Needham Market	Down Main	08 00 to 16 00. Construction work. 69½ and 76m.p. (86/19)
56 East Suffolk Jn and Claydon LC	Down and Up	08 00 to 16 00. Bridgework (No.254A). 70m. 17chs. (85/58)
57 Mellis	Down and Up	07 30 to 18 00. Demolition work. 91½mp. Mechanical equipment in use. (86/12)
58 Mellis and Trowse Lower Jn	All <u>Between Trains</u>	07 30 to 18 00. Signalling work. Points and signals disconnected. (86/15)
59 Diss and Mellis	Up	08 00 to 15 00. Construction work. 94m. 05chs. and 94m.p. (86/17)
60 Diss	Down and Up	07 00 to 19 00. Earthwork. Crane and mechanical equipment in use. (85/27)
61 Diss and Audley End LC	Down and Up	Bridgework (No. 315). 95m. 29chs. (86/16)
62 Diss and Tivetshall Jn	Down and Up	07 30 to 18 00. Demolition work 97m 50chs. Mechanical equipment in use. (86/12)
63 Tivetshall Jn	Down and Up	07 30 to 18 00. Demolition work. 100¾m.p. Mechanical equipment in use. (86/8)
64 Tivetshall Jn and Swainsthorpe	Down and Up <u>Between Trains</u>	07 30 to 18 00. Bridgework (Nos. 328 and 331A) and demolition work. 103m. 13chs. and 104m. 59chs. Crane and mechanical equipment in use. (86/8)

SECTION B - TEMPORARY ENGINEERING WORKS - continued

<u>At or between</u>	<u>Lines affected</u>	<u>Remarks</u>
<u>LIVERPOOL STREET TO NORWICH - continued</u>		
UNTIL FURTHER NOTICE - continued		
65 Swainsthorpe	Down and Up <u>Between Trains</u>	07 30 to 18 00. Demolition work. 109 $\frac{1}{2}$ m.p. Mechanical equipment in use. (86/8)
66 Swainsthorpe and Trowse Upper Jn.	Down and Up	07 00 to 16 00. Bridgework (No. 346) 110m. 62chs. Mechanical equipment in use. <u>From 07 00 Monday 15 September.</u> (86/25)
67 Trowse Lower Jn and Norwich Station	All <u>Between Trains</u>	07 00 to 17 00. Construction work (overhead line), earthwork, track maintenance and signalling work. Points and signals disconnected. (86/7)
68 Trowse Swing Bridge	Down and Up <u>Between Trains</u>	Bridgework (No. 356). 123m. 36chs. Crane and mechanical equipment in use. (85/33)
69 Trowse Swing Bridge and Thorpe Jn	Down and Up <u>Between Trains</u>	07 30 to 18 00. Construction work. 123 $\frac{1}{2}$ m.p. Crane and mechanical equipment in use. (86/3)
70 Norwich Station	All	Track renewal, platform work and earthwork. Crane and mechanical equipment in use. (85/62)

FRIDAY/SATURDAY 12/13 SEPTEMBER

71 Bethnal Green and Stratford (London End)	Down and Up Electric BLOCKED	23 00 to 05 00. Overhead line work. Mechanical equipment in use. <u>Isolation of electrical sections</u> <u>309A, 310B. Trains to travel over</u> <u>Main lines.</u>
---	------------------------------------	--

SECTION B - TEMPORARY ENGINEERING WORKS - continued

At or between	Lines affected	Remarks
---------------	----------------	---------

LIVERPOOL STREET TO NORWICH - continued

SATURDAY 13 TO SUNDAY 14 SEPTEMBER

72	Chadwell Heath Jn and Gidea Park Station Jn	Down and Up Electric BLOCKED to electric trains	20 30 to 21 15 Sat)Track renewal,)formation)renewal, track)maintenance and)overhead line
		Down and Up Electric BLOCKED	21 15 Sat to 22 00 Sun)work.)Mechanical)equipment in)use. <u>Isolation</u>
		Down and Up Main	21 15 Sat to 22 00 Sun)of <u>electrical</u>) <u>sections 325DE,</u>) <u>326AB.</u>) <u>20 30 to 21 15</u>) <u>Sat. Electric</u>) <u>trains to</u>) <u>travel over</u>) <u>Main lines.</u>) <u>21 15 Sat to</u>) <u>22 00 Sun.</u>) <u>Trains to</u>) <u>travel over</u>) <u>Main lines.</u>

SATURDAY/SUNDAY 13/14 SEPTEMBER

73	Bethnal Green and Bow Jn	Down and Up Main BLOCKED Down and Up Electric	23 00 to 11 00.	Signalling work, bridgework and overhead line work. Mechanical equipment in use. <u>Isolation of electrical sections</u> <u>311B, 312B. Trains to travel over</u> <u>Electric lines.</u>
74	Ilford Car Sheds (London End Jn) and Chadwell Heath Jn	Down and Up Main BLOCKED	23 00 to 19 00.	Drainage. Mechanical equipment in use. <u>Isolation of</u> <u>electrical sections 323B, 324D.</u> <u>Trains to travel over Electric lines.</u>
75	Ipswich Station	Platform 2 BLOCKED Platform 1 BLOCKED to electric trains	22 30 to 10 15.	Repairs to platform awnings. <u>Isolation of electrical</u> <u>sections 343F. Trains to be</u> <u>replatformed as necessary.</u>

SECTION B - TEMPORARY ENGINEERING WORKS - continued

At or between	Lines affected	Remarks
<u>LIVERPOOL STREET TO NORWICH - continued</u>		
SATURDAY/SUNDAY 13/14 SEPTEMBER - continued		
76 Haughley Jn and Diss	Down and Up BLOCKED	23 30 to 07 15. Trimming lineside vegetation, track renewal and track maintenance 93 and 93 $\frac{1}{2}$ m.p. Mechanical equipment in use.
77 Swainsthorpe and Trowse Lower Jn	Down and Up BLOCKED	23 55 to 16 30. Bridgework (No.346) 110m. 62chs. Mechanical equipment in use. <u>06 45 to 16 30 Sun.</u> <u>Possession to be given up for passage</u> <u>of trains.</u>
SATURDAY/SUNDAY 13/14 AND SUNDAY 14 SEPTEMBER		
78 Liverpool Street and Bethnal Green	Down and Up Suburban BLOCKED to electric trains	23 15 Sat to 18 00)Repairs to station)roof and overhead)work. Crane and)mechanical)equipment in use.
Liverpool Street Station	Platforms 9 and 10 BLOCKED to electric trains	23 15 Sat to 04 15) <u>Isolation of</u>) <u>electrical</u>) <u>sections 305 and</u>) <u>306. Electric</u>) <u>trains to travel</u>
	Platforms 1 to 8 inc. BLOCKED	23 15 Sat to 18 00) <u>over Main or</u>) <u>Electric lines.</u>) <u>Trains to be</u>) <u>replatformed as</u>
	Locomotive Holding Sidings BLOCKED to electric trains	23 15 Sat to 18 00) <u>necessary.</u>))))
	Platforms 9 and 10 BLOCKED	04 15 to 18 00 Sun)))
79 Witham and Kelvedon	Up BLOCKED Down BLOCKED	23 00 Sat to 07 15)Track maintenance)and track renewal.) <u>Possession to be</u> 00 55 to 07 15 Sun) <u>given up for</u>) <u>passage of 1Y02</u>) <u>02 20 Liverpool</u>) <u>Street to</u>) <u>Stowmarket over</u>) <u>Down line.</u>

SECTION B - TEMPORARY ENGINEERING WORKS - continued

<u>At or between</u>	<u>Lines affected</u>	<u>Remarks</u>
<u>LIVERPOOL STREET TO NORWICH - continued</u>		
SATURDAY/SUNDAY 13/14 AND SUNDAY 14 SEPTEMBER - continued		
80 Hill House G.F. Up and Stanway G.F.	BLOCKED Down BLOCKED	23 00 Sat to 07 30)Track maintenance,)formation renewal 01 00 to 16 00 Sun)and overhead line)work. Mechanical)equipment in use.) <u>Isolation of</u>) <u>electrical sections</u>) <u>340ABC.</u>) <u>23 00 Sat to 07 30</u>) <u>Possession to be</u>) <u>given up for</u>) <u>passage of 1Y02</u>) <u>02 20 Liverpool</u>) <u>Street to</u>) <u>Stowmarket over</u>) <u>Up line under</u>) <u>single line</u>) <u>working.</u>) <u>01 30 to 07 30 Sun.</u>) <u>Isolation of</u>) <u>electrical sections</u>) <u>339FGH.</u>) <u>07 30 to 16 00 Sun.</u>) <u>Single line working</u>) <u>over Up line.</u>
81 Thorpe Jn	Crown Point Depot Nos 1 and 2 Reception lines BLOCKED 'B' Line BLOCKED A11	22 00 Sat to 16 00)Track renewal and)drainage. Crane)and mechanical)equipment in use.) 23 00 Sat to 12 00)) 16 00 to 18 00 Sun)
SATURDAY 13 AND SUNDAY 14 SEPTEMBER		
82 Diss	A11	07 00 to 16 00 daily. Signalling work.

SECTION B - TEMPORARY ENGINEERING WORKS - continued

At or between	Lines affected	Remarks
---------------	----------------	---------

LIVERPOOL STREET TO NORWICH - continued

SUNDAY 14 SEPTEMBER

83	Forest Gate Jn and Stratford (Country End)	Up Electric	08 00 to 18 00. Signalling work.
84	Church Lane LC and Chelmsford	Down and Up BLOCKED	00 45 to 07 00. Track renewal and track maintenance. Mechanical equipment in use. <u>Possession to be given up for passage of trains.</u>
85	Ipswich Station and Claydon LC	Down Main BLOCKED	00 45 to 07 30. Loading materials. <u>Possession to be given up for passage of 1Y02 02 20 Liverpool Street to Stowmarket.</u>

SUNDAY/MONDAY 14/15 SEPTEMBER

86	Ipswich Station and Claydon LC	Down Main BLOCKED	23 05 to 03 50. Unloading materials. <u>Single line working over Up Main line.</u>
----	--------------------------------	----------------------	--

MONDAY 15 SEPTEMBER

87	Bethnal Green (London End) and Seven Sisters	Down and Up Suburban/ Down and Up BLOCKED to electric trains	01 00 to 04 30. In connection with overhead line work between Bethnal Green and Hackney Downs. <u>Isolation of electrical sections 313, 314, 401DE, 402ABC. Electric trains to travel over Fast lines and to be diverted via Clapton.</u>
88	Bow Jn and Stratford (Country End)	Down and Up Main BLOCKED	01 00 to 05 00. Overhead line work. <u>Isolation of electrical sections 311A, 312C, 319D, 320A. Trains to travel over Electric or Cambridge lines.</u>
89	Colchester (Country End) and East Suffolk Jn	All BLOCKED to electric trains	01 30 to 04 00. In connection with overhead line work. <u>Isolation of electrical sections 341, 342, 343 and 344.</u>

SECTION B - TEMPORARY ENGINEERING WORKS - continued

At or between	Lines affected	Remarks
---------------	----------------	---------

LIVERPOOL STREET TO NORWICH - continued

MONDAY 15 SEPTEMBER - continued

90	Manningtree South Jn and Manningtree North Jn	Down and Up BLOCKED	01 30 to 04 00. Overhead line work. <u>Possession to be given up for passage of Diesel trains.</u>
----	---	------------------------	---

MONDAY/TUESDAY 15/16 SEPTEMBER

91	Diss and Haughley Jn	Up BLOCKED	21 30 to 05 00. Track maintenance and trimming lineside vegetation. Mechanical equipment in use. <u>Possession to be given up for passage of trains.</u>
----	-------------------------	---------------	---

MONDAY 15 TO THURSDAY 18 SEPTEMBER

92	Goodmayes Jn and Gidea Park Jn	Down and Up Main BLOCKED	22 10 Mon to Wed to 05 00 Tue to Thu. Track maintenance and undertrack excavation. Mechanical equipment in use. <u>Isolation of electrical sections 323A, 324E. Trains to travel over Electric lines.</u>
93	Chadwell Heath Jn and Gidea Park Station Jn	Down and Up Electric BLOCKED	10 15 to 15 15 daily. Track maintenance. Mechanical equipment in use. <u>Trains to travel over Main lines.</u>

MONDAY 15 TO FRIDAY 19 SEPTEMBER

94	Witham and New Hall G.F.	Up	09 00 to 16 00 daily. Track maintenance. 33m. 26chs. and 33m. 21chs.
----	-----------------------------	----	--

MONDAY 15 TO SATURDAY 20 SEPTEMBER

95	Bethnal Green and Stratford (London End)	Down and Up Electric BLOCKED	23 00 Mon to Fri to 05 00 Tue to Sat. Overhead line work. Mechanical equipment in use. <u>Isolation of electrical sections 309A, 310B. Trains to travel over Main lines.</u>
----	--	------------------------------------	--

SECTION B - TEMPORARY ENGINEERING WORKS - continued

At or between	Lines affected	Remarks
---------------	-------------------	---------

LIVERPOOL STREET TO NORWICH - continued

TUESDAY 16 SEPTEMBER

96 Hill House G.F. and Marks Tey Station	Down BLOCKED	00 01 to 04 50. Track maintenance. Mechanical equipment in use. <u>Single line working over Up line.</u>
97 Swainsthorpe and Trowse Lower Jn	Down and Up	09 00 to 15 00. Unloading materials.

TUESDAY 16 TO THURSDAY 18 SEPTEMBER

98 Barham and Stowmarket Station (London End)	Down Main BLOCKED	23 30 Tue and Wed to 05 45 Wed and Thu. Track maintenance. Mechanical equipment in use. <u>Single line working over Up Main line.</u>
99 Swainsthorpe and Tivetshall Jn	Up BLOCKED	21 30 Tue and Wed to 05 00 Wed and Thu. Trimming lineside vegetation. Mechanical equipment in use. <u>Possession to be given up for passage of 1C03 23 35 Norwich to Liverpool Street.</u>

WEDNESDAY 17 SEPTEMBER

100 Marks Tey Station and Hill House G.F.	Up BLOCKED	00 01 to 04 50. Track maintenance. Mechanical equipment in use. <u>Single line working over Down line.</u>
101 Cow Green and Diss	Down and Up	09 00 to 15 00. Unloading materials.

WEDNESDAY 17 TO FRIDAY 19 SEPTEMBER

102 Norwich Station	All BLOCKED	23 15 Wed and Thu to 05 00 Thu and Fri. Track maintenance. Mechanical equipment in use. <u>Possession to be given up for passage of trains. Trains between Crown Point and Norwich to travel via 'A'/'E' line.</u>
------------------------	----------------	--

SECTION B - TEMPORARY ENGINEERING WORKS - continued

At or between	Lines affected	Remarks
<u>LIVERPOOL STREET TO NORWICH - continued</u>		
THURSDAY 18 SEPTEMBER		
103 Stanway G.F. and Marks Tey Station	Up BLOCKED	00 01 to 04 45. Track maintenance. Mechanical equipment in use. <u>Single line working over Down line.</u>
104 Tivetshall Jn and Swainsthorpe	Down and Up	09 00 to 15 00. Unloading materials.
THURSDAY/FRIDAY 18/19 SEPTEMBER		
105 Goodmayes Jn and Gidea Park Jn	Down and Up Main BLOCKED	22 10 to 05 00. Track maintenance. <u>Trains to travel over Electric lines.</u>
106 Diss and Haughley Jn.	Up BLOCKED	21 30 to 05 00. Trimming lineside vegetation. Mechanical equipment in use. <u>Possession to be given up for passage of 1C03 23 35 Norwich to Liverpool Street.</u>
FRIDAY/SATURDAY 19/20 SEPTEMBER		
107 Bow Jn and Stratford	Down Cambridge and Carriage Roads 'A' and 'B'/Down and Up Goods BLOCKED to electric trains	23 30 to 03 45. In connection with engineering work (repairs to signal gantry). <u>Isolation of electrical sections 432AB, 433.</u>
<u>STRATFORD CENTRAL JN EAST TO COPPERMILL NORTH JN</u>		
SUNDAY 14 SEPTEMBER		
108 Temple Mills East Jn and Copper Mill North Jn.	Down and Up BLOCKED	08 00 to 16 30. Track renewal 6m. 24chs. and 6m. 27chs. Crane and mechanical equipment in use. <u>Possession to be given up for passage of Engineers' trains. 5C83 13 45 Cambridge to Thornton Field Car.MD. diverted via Southbury and Liverpool Street.</u>

SECTION B - TEMPORARY ENGINEERING WORKS - continued

At or between	Lines affected	Remarks
<u>NAVARINO ROAD JN TO NORTH WOOLWICH</u>		
UNTIL FURTHER NOTICE		
109 Highbury and Homerton	All	07 30 to 18 00. Earthwork and construction work. Mechanical equipment in use. (86/1)
SUNDAY 14 SEPTEMBER		
110 Navarino Road Jn and Channelsea North Jn	Down and Up BLOCKED	00 01 to 08 00. Construction work (overhead line). Crane and mechanical equipment in use. <u>Isolation of electrical sections 707 and 708.</u>
111 Channelsea North Jn and Stratford Central Jn West	Down and Up	00 01 to 08 00. Construction work (overhead line). <u>Isolation of electrical sections 705C, 706A.</u>
MONDAY 15 SEPTEMBER		
112 Dalston Western Jn and Hackney Central	All BLOCKED to AC electric trains	01 00 to 04 30. In connection with overhead line work between Bethnal Green and Hackney Downs. <u>Isolation of electrical sections 314.</u>
<u>STRATFORD, LEA JN TO HIGH MEADS JN</u>		
SUNDAY 14 SEPTEMBER		
113 Lea Jn and High Meads Jn	Down and Up BLOCKED	00 01 to 08 00. Construction work (overhead line). Crane and mechanical equipment in use.
<u>CHANNELSEA NORTH JN TO TEMPLE MILLS EAST JN</u>		
SUNDAY 14 SEPTEMBER		
114 High Meads Jn and Temple Mills East Jn	Down and Up <u>Between Trains</u>	08 00 to 16 30. Track maintenance.

SECTION B - TEMPORARY ENGINEERING WORKS - continued

At or between	Lines affected	Remarks
---------------	----------------	---------

CHANNELSEA SOUTH JN TO STRATFORD CENTRAL JN WEST

UNTIL FURTHER NOTICE

115	Channelsea South Jn and Stratford Central Jn West	Down and Up BLOCKED to electric trains	In connection with engineering work. (86/14)
-----	---	--	---

SUNDAY 14 SEPTEMBER

116	Channelsea North Jn and Stratford Central Jn West	Down and Up	00 01 to 08 00. Construction work (overhead line). <u>Isolation of electrical sections 705C, 706A.</u>
-----	---	-------------	--

FOREST GATE JN TO WOODGRANGE PARK JN

FRIDAY/SATURDAY 12/13 SEPTEMBER

117	Barking Station (Country End) and Forest Gate Jn	Up Tilbury/Up and Up Goods Loop BLOCKED to electric trains	23 59 to 04 15. In connection with engineering work. <u>Isolation of electrical sections 513.</u>
-----	--	--	---

SUNDAY 14 SEPTEMBER

118	Forest Gate Jn and Barking Station (Country End)	All BLOCKED to electric trains	00 50 to 06 15. In connection with engineering work between Woodgrange Park Jn and Barking Tilbury Line Jn West. <u>Isolation of electrical sections 512 and 513.</u>
-----	--	--------------------------------------	---

SHENFIELD JN TO SOUTHEND VICTORIA

UNTIL FURTHER NOTICE

119	Billericay	Down and Up	07 30 to 17 30. Construction work and platform work. Mechanical equipment in use. (86/19)
120	Wickford Station	All	Platform work and earthwork. (85/63)

SECTION B - TEMPORARY ENGINEERING WORKS - continued

At or between	Lines affected	Remarks
---------------	----------------	---------

SHENFIELD JN TO SOUTHEND VICTORIA - continued

UNTIL FURTHER NOTICE - continued

121	Wickford Jn	All	08 00 to 17 00. Signalling work. (85/41)
122	Rayleigh and Hockley	Down	08 00 to 17 00. Earthwork 34½ and 34¾ m.p. Mechanical equipment in use. (85/61)
123	Southend Victoria Station	All	08 00 to 18 00. Repairs to station roof. (86/20)

TUESDAY 16 TO FRIDAY 19 SEPTEMBER

124	Billericay and Hockley	All BLOCKED to electric trains	00 30 to 04 10. In connection with overhead line work between Wickford Jn and Southminster. <u>Isolation of electrical sections 373 and 374.</u>
-----	---------------------------	--------------------------------------	--

WICKFORD JN TO SOUTHMINSTER

UNTIL FURTHER NOTICE

125	Wickford Jn	All	08 00 to 17 00. Signalling work. (85/41)
126	Fambridge Station	Single	07 30 to 18 00. Platform work. (85/55)
127	Burnham-on- Crouch	Single	07 30 to 18 00. Earthwork. 43m 24chs. (85/30)

SUNDAY 14 SEPTEMBER

128	Wickford Jn and Southminster	Single BLOCKED	00 30 to 07 00. Track maintenance. Mechanical equipment in use.
-----	------------------------------------	-------------------	--

TUESDAY 16 TO FRIDAY 19 SEPTEMBER

129	Wickford Jn and Southminster	Single BLOCKED	00 30 to 04 10 daily. Overhead line work. Mechanical equipment in use. <u>Isolation of electrical section 377.</u>
-----	------------------------------------	-------------------	--

SECTION B - TEMPORARY ENGINEERING WORKS - continued

At or between	Lines affected	Remarks
<u>WITHAM TO BRAINTREE</u>		
UNTIL FURTHER NOTICE		
130 Witham and Braintree	Single	07 00 to 18 00. Construction work (Bridge No. 2102B). (86/19)
<u>COLCHESTER TO CLACTON</u>		
UNTIL FURTHER NOTICE		
131 Colchester Jn and East Gate Jn	Down Clacton Avoiding	08 00 to 17 00. Earthwork. 52m. 25chs. and 52m. 29chs. Mechanical equipment in use. (85/38)
SATURDAY/SUNDAY 13/14 SEPTEMBER		
132 East Gate Jn and Thorpe-le-Soken	Down and Up BLOCKED	23 30 to 07 15. Track maintenance, track renewal and loading materials. 60 and 60½m.p. Mechanical equipment in use.
<u>MANNINGTREE SOUTH JN TO HARWICH</u>		
UNTIL FURTHER NOTICE		
133 Wrabness and Mistley	Up	07 30 to 17 00. Earthwork. 64m. 46chs. and 64m. 15chs. Mechanical equipment in use. (85/65)
134 Parkeston West and Harwich Town	Single	07 30 to 18 00. Track maintenance, track renewal and earthwork. 70½m.p. Mechanical equipment in use. (85/27)
FRIDAY/SATURDAY 12/13 SEPTEMBER		
135 Manningtree South Jn and Harwich Town	All BLOCKED to electric trains	23 45 to 04 30. In connection with overhead line work between Wrabness and Dovercourt. <u>Isolation of electrical sections 391 and 392.</u>

SECTION B - TEMPORARY ENGINEERING WORKS - continued

<u>At or between</u>	<u>Lines affected</u>	<u>Remarks</u>
----------------------	-----------------------	----------------

MANNINGTREE SOUTH JN TO HARWICH - continued

FRIDAY/SATURDAY 12/13 SEPTEMBER - continued

136	Wrabness and Dovercourt	All BLOCKED	23 45 to 04 30. Overhead line work. Mechanical equipment in use. <u>Possession to be given up for passage of trains.</u>
-----	----------------------------	----------------	--

MONDAY 15 SEPTEMBER

137	Manningtree South Jn and Harwich Town	All BLOCKED to electric trains	01 30 to 04 00. In connection with overhead line work. <u>Isolation of electrical sections 391 and 392.</u>
-----	---	--------------------------------------	--

MONDAY 15 TO SATURDAY 20 SEPTEMBER

138	Manningtree South Jn and Harwich Town	All BLOCKED to electric trains	23 45 Mon to Fri to 04 30 Tue to Sat. In connection with overhead line work between Wrabness and Dovercourt. <u>Isolation of electrical sections 391 and 392.</u>
-----	---	--------------------------------------	--

139	Wrabness and Dovercourt	All BLOCKED	23 45 Mon to Fri to 04 30 Tue to Sat. Overhead line work. Mechanical equipment in use. <u>Possession to be given up for passage of Diesel trains.</u>
-----	----------------------------	----------------	---

MANNINGTREE EAST JN TO NORTH JN

MONDAY 15 SEPTEMBER

140	Manningtree East Jn and Manningtree North Jn	Single BLOCKED	01 30 to 04 00. Overhead line work. <u>Isolation of electrical sections 343 and 392. Possession to be given up for passage of 5F56 01 55 Ipswich to Harwich Parkeston Quay (Diesel hailed).</u>
-----	---	-------------------	--

EAST SUFFOLK JN TO OULTON BROAD NORTH JN

UNTIL FURTHER NOTICE

141	Melton and Wickham Market	Single	07 00 to 18 00. Bridgework (No. 426). 81m. 11chs. Crane in use.
-----	------------------------------	--------	--

SECTION B - TEMPORARY ENGINEERING WORKS - continued

At or between	Lines affected.	Remarks
---------------	-----------------	---------

EAST SUFFOLK JN TO OULTON BROAD NORTH JN - continued

UNTIL FURTHER NOTICE - continued

142	Oulton Broad North Jn	All	08 00 to 17 00. Signalling work. (85/41)
-----	--------------------------	-----	---

SATURDAY/SUNDAY 13/14 SEPTEMBER

143	Woodbridge Station	Down and Up BLOCKED	23 10 to 07 30. Painting platform awnings.
-----	-----------------------	------------------------	---

MONDAY 15 TO FRIDAY 19 SEPTEMBER

144	Woodbridge and Saxmundham	All BLOCKED	23 15 Mon to Thu to 06 15 Tue to Fri. Loading rails. Crane and mechanical equipment in use.
-----	------------------------------	----------------	---

145	Halesworth and Oulton Broad North Jn	Single	08 00 to 16 00 daily. Track maintenance 100% and 115% m.p. Mechanical equipment in use.
-----	--	--------	---

WESTERFIELD JN TO FELIXSTOWE

UNTIL FURTHER NOTICE

146	Westerfield Jn and Derby Road	Single	08 00 to 16 00. Earthwork. 73m. 13chs. and 73 $\frac{1}{2}$ m.p. (85/61)
-----	----------------------------------	--------	--

147	Derby Road and Felixstowe Beach Jn	Single	07 30 to 17 00. Earthwork. 82% and 83m.p. Mechanical equipment in use. (86/1)
-----	--	--------	---

SATURDAY/SUNDAY 13/14 SEPTEMBER

148	Westerfield Jn and Derby Road	Single BLOCKED	23 00 to 07 30. Track maintenance. Mechanical equipment in use.
-----	----------------------------------	-------------------	--

NORWICH TO LOWESTOFT

UNTIL FURTHER NOTICE

149	Norwich Station	All	Track renewal, platform work and earthwork. Crane and mechanical equipment in use. (85/62)
-----	--------------------	-----	---

SECTION B - TEMPORARY ENGINEERING WORKS - continued

At or between	Lines affected	Remarks
---------------	----------------	---------

NORWICH TO LOWESTOFT

UNTIL FURTHER NOTICE - continued

150	Norwich Station All and Trowse Lower Jn	- <u>Between Trains</u>	07 00 to 17 00. Construction work (overhead line), earthwork, track maintenance and signalling work. Points and signals disconnected. (86/7)
151	Thorpe Jn	All	08 00 to 17 00. Earthwork and track maintenance. (85/22)
152	Whitlingham Jn and Thorpe Jn	Up	07 30 to 17 00. Earthwork 1½ and 1m.p. Mechanical equipment in use. (86/13)
153	Whitlingham Jn and Brundall Jn	Down and Up	07 00 to 16 00. Signalling work.
154	Brundall Jn and Reedham Swing Bridge	Down and Up	07 00 to 18 00. Earthwork. 7m. 34chs. and signalling work. (85/16)
155	Reedham Swing Bridge	Down and Up BLOCKED	08 00 to 16 00. Bridgework (No. 1238). <u>Possession to be given up for passage of trains.</u> (86/23)
156	Oulton Broad North Jn	All	08 00 to 17 00. Signalling work. (85/41)

SATURDAY/SUNDAY 13/14 AND SUNDAY 14 SEPTEMBER

157	Thorpe Jn	Crown Point Depot Nos. 1 and 2 Reception lines BLOCKED 'B' line BLOCKED All	22 00 Sat to 16 00)Track renewal and)drainage.)Crane and)mechanical)equipment in use. 23 00 Sat to 12 00)) 16 00 to 18 00 Sun)
-----	-----------	--	--

SECTION B - TEMPORARY ENGINEERING WORKS - continued

At or between	Lines affected	Remarks
---------------	----------------	---------

NORWICH TO LOWESTOFT - continuedSATURDAY/SUNDAY 13/14 AND SUNDAY 14 SEPTEMBER - continued

.158	Brundall Jn and Reedham Jn	Down and Up BLOCKED Down and Up	23 40 Sat to 08 00) 08 00 to 16 00 Sun)	Loading rails and track maintenance. Crane and mechanical equipment in use. <u>Possession to be given up for passage of trains.</u>
------	----------------------------------	---------------------------------------	--	--

WEDNESDAY 17 TO FRIDAY 19 SEPTEMBER

159	Norwich Station	All BLOCKED	23 15 Wed and Thu to 05 00 Thu and Fri. Track maintenance. Mechanical equipment in use. <u>Possession to be given up for passage of trains. Trains between Crown Point and Norwich to travel via 'A'/'E' line.</u>
-----	--------------------	----------------	--

WHITLINGHAM JN TO CROMER

UNTIL FURTHER NOTICE

160	Whitlingham Jn and Wroxham	Down and Up	07 30 to 16 30. Bridgework (No. 365). 3m. 48chs. (86/6)
161	Cromer Station	Platforms 1 and 2	Platform work. (86/15)

CROMER TO SHERINGHAM

UNTIL FURTHER NOTICE

162	Cromer Station	Platforms 1 and 2	Platform work. (86/15)
-----	----------------	----------------------	---------------------------

SECTION B - TEMPORARY ENGINEERING WORKS - continued

<u>At or between</u>	<u>Lines affected</u>	<u>Remarks</u>
<u>BRUNDALL JN TO YARMOUTH VIA ACLE</u>		
UNTIL FURTHER NOTICE		
163	Lingwood Single	08 00 to 17 00. Construction work. 8m. 03chs. (86/12)
164	Acle Station Down and Up	08 00 to 17 00. Platform work. (86/20)
<u>BETHNAL GREEN JN TO KING'S LYNN</u>		
UNTIL FURTHER NOTICE		
165	Cambridge Heath Station Down and Up Suburban	08 00 to 17 00. Platform work. Mechanical equipment in use. <u>(See Section 'D')</u> . (86/24)
166	Enfield Lock and Waltham Cross Down and Up	07 00 to 18 00. Bridgework (No.1418C). 12m. 34chs. Crane and mechanical equipment in use. (85/59)
167	Bishops Stortford (Country end) and Stansted Down and Up Main BLOCKED to electric trains	Overhead line work. <u>Isolation of electrical sections 427, 428 (buffer section)</u> . (85/41)
168	Bishops Stortford and Cambridge (North) All	07 00 to 18 00. Construction work (overhead line). Mechanical equipment in use. (85/21)
169	Stansted Down and Up	Construction work. 33m. 29chs. (85/61)
170	Elsenham Down and Up	Construction work. 35m. 44chs. (85/61)
171	Newport Down and Up	08 00 to 16 00. Platform work 39m. 74chs. Mechanical equipment in use. (85/37)
172	Whittlesford Station Down	Platform work 49m 02chs. Mechanical equipment in use. (86/21)

SECTION B - TEMPORARY ENGINEERING WORKS - continued

At or between	Lines affected	Remarks
---------------	----------------	---------

BETHNAL GREEN JN TO KING'S LYNN - continued

UNTIL FURTHER NOTICE .- continued

173 Shelford	Down and Up	Platform work. 52m. 36chs. Mechanical equipment in use. (86/6)
--------------	-------------	--

SATURDAY 13 SEPTEMBER

174 Bethnal Green (Country End) and Bury Street Jn	Down and Up Suburban/ Down and Up BLOCKED to electric trains	00 20 to 04 35. In connection with overhead line work between Hackney Downs North Jn and Seven Sisters. <u>Isolation of electrical sections 401 and 402. Electric trains to travel over Fast lines and to be diverted via Clapton.</u>
---	--	---

SATURDAY/SUNDAY 13/14 SEPTEMBER

175 Audley End and Whittlesford Crossovers	Up Main BLOCKED Down Main BLOCKED	22 20 to 08 15)Construction work) (overhead line) and 22 20 to 10 00)trimming lineside)vegetation. 41% and)49%a.p. Mechanical)equipment in use.)Possession to be)given up for passage)of 1P04 02 10)Liverpool Street to)Yarmouth and 1H02)03 10 Liverpool Street)to King's Lynn over)Down Main line.
--	--	---

SECTION B - TEMPORARY ENGINEERING WORKS - continued

At or between	Lines affected	Remarks
BETHNAL GREEN JN TO KING'S LYNN - continued		
SATURDAY/SUNDAY 13/14 AND SUNDAY 14 SEPTEMBER		
176 Broxbourne Jn and Harlow Town	Up BLOCKED Down BLOCKED	23 05 Sat to 16 00 Sun) Track renewal,)bridgework (No.1436) and)00 15 to 08 45 Sun) overhead line work.)Crane and)mechanical)equipment in use.)00 15 to 08 45 Sun) <u>Possession to be</u>) <u>given up for</u>) <u>passage of 1P04</u>) <u>02 10 Liverpool</u>) <u>Street to Yarmouth</u>) <u>and 1H02 03 10</u>) <u>Liverpool Street to</u>) <u>King's Lynn over</u>) <u>Down line.</u>) <u>08 30 to 16 00 Sun.</u>) <u>Isolation of</u>) <u>electrical</u>) <u>sections 415E.</u>) <u>08 45 to 16 00</u>) <u>Single line working</u>) <u>over Down line.</u>
177 Shepreth Branch Jn and Cambridge	Down Goods Loop South and Down and Up Goods BLOCKED Down and Up Main <u>Between trains</u>	21 00 Sat to 09 00 Sun) Construction work) <u>(overhead line).</u>)53 and 55%mp.)Mechanical)equipment in use.) <u>Trains to travel</u>) <u>over other lines.</u>)
178 Cambridge Station	Down and Up Goods BLOCKED Platform line and Through line BLOCKED	21 00 Sat to 09 00 Sun) Track maintenance,)construction work) <u>(overhead line)</u>)and signalling)work. 55% and)55%mp. Mechanical)equipment in use.) <u>Possession to be</u>) <u>given up for</u>) <u>passage of trains</u>) <u>over Platform</u>) <u>line.</u>

SECTION B - TEMPORARY ENGINEERING WORKS - continued

At or between	Lines affected	Remarks
<u>BETHNAL GREEN JN TO KING'S LYNN - continued</u>		
SATURDAY/SUNDAY 13/14 AND SUNDAY 14 SEPTEMBER - continued		
179 Cambridge and Coldham Lane Jn	Down and Up Goods BLOCKED Down and Up Main <u>Between Trains</u>	21 00 Sat to 09 00 Sun) Construction work (overhead line). 55½ and 56¼mp. 01 30 to 07 30 Sun) Mechanical equipment in use. <u>Trains to travel over other lines.</u>

SATURDAY 13 AND SUNDAY 14 SEPTEMBER

180 Whittlesford Station	Down Main <u>Between Trains</u>	08 00 to 16 00 daily. Construction work. 49m. 02chs. Mechanical equipment in use.
--------------------------	------------------------------------	---

SATURDAY 13 TO MONDAY 15 SEPTEMBER

181 Chesterton Jn and Waterbeach	Down BLOCKED Up BLOCKED	22 30 Sat to 03 30 ¹ Mon) Bridgework (No. 1550B). 00 01 Sun to 03 30 Mon) 58m. 65chs. Crane and mechanical equipment in use. <u>Possession to be given up for passage of 1P04 02 10 Liverpool Street to Yarmouth and 1H02 03 10 Liverpool Street to King's Lynn over Down line.</u>
----------------------------------	----------------------------------	--

SUNDAY 14 SEPTEMBER

182 Clapton Jn and Cheshunt Jn	Down and Up Main BLOCKED to electric trains	00 01 to 22 00. In connection with engineering work between Tottenham South Jn and Cheshunt Jn. <u>Isolation of electrical sections 411 and 412. Electric trains diverted via Southbury.</u>
--------------------------------	---	--

SECTION B - TEMPORARY ENGINEERING WORKS - continued

<u>At or between</u>	<u>Lines affected</u>	<u>Remarks</u>
----------------------	-----------------------	----------------

BETHNAL GREEN JN TO KING'S LYNN - continued

SUNDAY 14 SEPTEMBER - continued

183	Tottenham South Jn and Cheshunt Jn	Down and Up Main BLOCKED	00 01 to 22 00. Formation renewal, track maintenance, track renewal and overhead line work. Crane and mechanical equipment in use. <u>Trains diverted via Southbury.</u>
184	Cheshunt Jn and Bishops Stortford	All	08 00 to 17 00. Signalling work.
185	Broxbourne Jn and Bishops Stortford	All BLOCKED to electric trains	00 35 to 08 30. In connection with engineering work between Broxbourne Jn and Harlow Town. <u>Isolation of electrical sections 413A, 414J, 415, 416, 417 and 418.</u>

MONDAY 15 SEPTEMBER

186	Bethnal Green (London End) and Seven Sisters	Down and Up Suburban/ Down and Up BLOCKED to electric trains	01 00 to 04 30. In connection with overhead line work between Bethnal Green and Hackney Downs. <u>Isolation of electrical sections 313, 314, 401DE, 402ABC. Electric trains to travel over Fast lines and to be diverted via Clapton.</u>
187	Bethnal Green and Hackney Downs	Down and Up Fast BLOCKED	10 15 to 15 00. Track maintenance 1m. 70chs. and 2m. 21chs. <u>Trains to travel over Suburban lines.</u>
188	Bethnal Green (Country End) and Hackney Downs	Down and Up Suburban BLOCKED	01 00 to 04 30. Overhead line work. <u>Trains to travel over Fast lines.</u>

MONDAY/TUESDAY 15/16 SEPTEMBER

189	Stansted and Elsenham	Down BLOCKED	22 30 to 04 55. Track maintenance 33% and 35m.p. Mechanical equipment in use. <u>Single line working over Up line.</u>
-----	--------------------------	-----------------	--

SECTION B - TEMPORARY ENGINEERING WORKS - continued

At or between	Lines affected	Remarks
<u>BETHNAL GREEN JN TO KING'S LYNN - continued</u>		
MONDAY 15 TO FRIDAY 19 SEPTEMBER		
190 Harlow Town and Broxbourne Jn	Up BLOCKED	23 05 Mon to Thu to 04 40 Tue to Fri. Track maintenance. Mechanical equipment in use. <u>Single line working over Down line.</u>
191 Cambridge (South) and Coldham Lane Jn	All <u>Between Trains</u>	08 00 to 18 00 daily. Construction work (overhead line). 55½ and 56¾m.p. Mechanical equipment in use.
TUESDAY 16 SEPTEMBER		
192 Bethnal Green and Hackney Downs	Down and Up Fast BLOCKED	10 15 to 15 00. Unloading materials, track maintenance and overhead line work. <u>Trains to travel over Suburban lines. 10 45 to 14 30 Isolation of electrical sections 315, 316, 407C, 408A.</u>
TUESDAY 16 TO FRIDAY 19 SEPTEMBER		
193 Bethnal Green (Country End) and Bury Street Jn	Down and Up Suburban/ Down and Up BLOCKED to electric trains	00 20 to 04 35 daily. In connection with engineering work between Hackney Downs North Jn and Seven Sisters. <u>Isolation of electrical sections 401 and 402. Electric trains to travel over Fast lines and to be diverted via Clapton.</u>
WEDNESDAY 17 TO FRIDAY 19 SEPTEMBER		
194 Bethnal Green and Hackney Downs	Down and Up Fast BLOCKED	10 15 to 15 00 daily. Unloading materials and track maintenance <u>Trains to travel over Suburban lines.</u>
195 Ely North Jn and Littleport	Down and Up BLOCKED	23 00 Wed and Thu to 05 00 Thu and Fri. Track maintenance. 72 and 76m.p. Mechanical equipment in use.

SECTION B - TEMPORARY ENGINEERING WORKS - continued

At or between	Lines affected	Remarks
---------------	----------------	---------

READING LANE JN TO NAVARINO ROAD JN (GRAHAM ROAD CURVE)

MONDAY 15 SEPTEMBER

196 Reading Lane Jn and Navarino Road Jn	Single BLOCKED to electric trains	01 00 to 04 30. In connection with overhead line work between Bethnal Green and Hackney Downs. <u>Isolation of electrical sections 314.</u>
--	---	---

HACKNEY DOWNS NORTH JN. TO ENFIELD TOWN

SATURDAY 13 SEPTEMBER

197 Bethnal Green (Country End) and Bury Street Jn	Down and Up Suburban/ Down and Up BLOCKED to electric trains	00 20 to 04 35. In connection with overhead line work between Hackney Downs North Jn and Seven Sisters. <u>Isolation of electrical sections 401 and 402. Electric trains to travel over Fast lines and to be diverted via Clapton.</u>
198 Hackney Downs North Jn and Seven Sisters	Down and Up BLOCKED	00 20 to 04 35. Overhead line work. Mechanical equipment in use. <u>Trains diverted via Clapton.</u>

MONDAY 15 SEPTEMBER

199 Bethnal Green (London End) and Seven Sisters	Down and Up Suburban/ Down and Up BLOCKED to electric trains	01 00 to 04 30. In connection with overhead line work between Bethnal Green and Hackney Downs. <u>Isolation of electrical sections 313, 314, 401DE, 402ABC. Electric trains to travel over Fast lines and to be diverted via Clapton.</u>
--	--	---

TUESDAY 16 TO FRIDAY 19 SEPTEMBER

200 Bethnal Green (Country End) and Bury Street Jn	Down and Up Suburban/ Down and Up BLOCKED to electric trains	00 20 to 04 35 daily. In connection with engineering work between Hackney Downs North Jn and Seven Sisters. <u>Isolation of electrical sections 401 and 402. Electric trains to travel over Fast lines and to be diverted via Clapton.</u>
--	--	--

SECTION B - TEMPORARY ENGINEERING WORKS - continued

At or between	Lines affected	Remarks
---------------	----------------	---------

HACKNEY DOWNS NORTH JN. TO ENFIELD TOWN - continued

TUESDAY 16 TO FRIDAY 19 SEPTEMBER - continued

201	Hackney Downs North Jn and Seven Sisters	Down and Up BLOCKED	00 20 to 04 35 daily. Overhead line work and track maintenance. Mechanical equipment in use. <u>Trains diverted via Clapton.</u>
202	Seven Sisters and Enfield Town/ Cheshunt Jn	All BLOCKED	00 35 to 04 30 daily. Track maintenance. Mechanical equipment in use. <u>Trains diverted via Clapton.</u>

BURY STREET JN TO CHESHUNT

SUNDAY 14 SEPTEMBER

203	Bury Street Jn and Cheshunt Jn	Down and Up	08 00 to 17 00. Signalling work.
-----	--------------------------------------	-------------	----------------------------------

TUESDAY 16 TO FRIDAY 19 SEPTEMBER

204	Seven Sisters and Enfield Town/ Cheshunt Jn	All BLOCKED	00 30 to 04 30 daily. Track maintenance. Mechanical equipment in use. <u>Trains diverted via Clapton.</u>
-----	--	----------------	---

CLAPTON JN TO CHINGFORD

SUNDAY 14 SEPTEMBER

205	Chingford	All	08 00 to 17 00. Signalling work.
-----	-----------	-----	----------------------------------

BROXBOURNE JN. TO HERTFORD EAST

UNTIL FURTHER NOTICE

206	Rye House and St. Margarets	Down and Up	08 00 to 18 00. Bridgework (No. 2035A). 19m. 66chs. Mechanical equipment in use. (85/60)
-----	--------------------------------	-------------	--

SECTION B - TEMPORARY ENGINEERING WORKS - continued

At or between	Lines affected	Remarks	
<u>COLDHAM LANE JN. TO HAUGHLEY JN.</u>			
UNTIL FURTHER NOTICE			
207	Bury St. Edmunds Station	Down	08 00 to 15 00. Repairs to platform awnings. (86/18)
208	Bury St. Edmunds and Elmswell	Down and Up	08 00 to 18 00. Drainage 29m. 78chs. Mechanical equipment in use. (86/12)
SATURDAY/SUNDAY 13/14 SEPTEMBER			
209	Bury St. Edmunds and Haughley Jn	Up BLOCKED Down BLOCKED	22 00 to 08 00) Drainage, demolition work, track 23 15 to 16 00) maintenance, track renewal and formation renewal. Mechanical equipment in use.) <u>08 00 to 16 00 Sun</u>) <u>Single line working</u>) <u>over Up line.</u>
THURSDAY/FRIDAY 18/19 SEPTEMBER			
210	Elmswell and Haughley Jn	Down BLOCKED	23 00 to 05 30. Track maintenance. Mechanical equipment in use. <u>Single line working over Up line.</u>
<u>CHIPPENHAM JN. TO ELY DOCK JN.</u>			
UNTIL FURTHER NOTICE			
211	Soham and Chippenham Jn	Up <u>Between Trains</u>	07 00 to 19 00. Earthwork and track renewal 3m.p. Mechanical equipment in use. (86/22)
SATURDAY/SUNDAY 13/14 SEPTEMBER			
212	Chippenham Jn and Soham	Down and Up BLOCKED	22 00 to 08 30. Track maintenance 1 $\frac{1}{2}$ and 7 $\frac{1}{2}$ m.p. Mechanical equipment in use.
SUNDAY 14 SEPTEMBER			
213	Chippenham Jn and Soham	Down and Up	08 30 to 12 00. Signalling work. <u>(Section 'C')</u> .

SECTION B - TEMPORARY ENGINEERING WORKS - continued

At or between	Lines affected	Remarks
<u>ELY NORTH JN TO PETERBOROUGH, CRESCENT JN</u>		
SATURDAY/SUNDAY 13/14 SEPTEMBER		
214 Black Bank and Manea	Down and Up BLOCKED	23 30 to 08 30. Bridgework (No. 1814) 78m. 41chs. Crane in use.
215 March West Jn and Crecent Jn	Down and Up Main BLOCKED	23 30 to 08 00. Bridgework (No. 184), repairing fencing and track maintenance. 89 and 100% <u>m.p.</u> Mechanical equipment in use.
TUESDAY 16 AND WEDNESDAY 17 SEPTEMBER		
216 Chettisham and Black Bank	Down <u>Between Trains</u>	08 00 to 16 00 daily. Track maintenance. 75 and 75% <u>m.p.</u> Mechanical equipment in use.
FRIDAY 19 SEPTEMBER		
217 Manea and Black Bank	Up <u>Between Trains</u>	00 01 to 08 00. Track maintenance. 76 and 75% <u>m.p.</u>
<u>ELY NORTH JN TO TROWSE LOWER JN</u>		
UNTIL FURTHER NOTICE		
218 Thetford and Lakenheath	Up	08 00 to 16 00. Track maintenance. 87% and 85% <u>m.p.</u> (86/24)
219 Wymondham and Hethersett	Down and Up <u>Between Trains</u>	07 30 to 18 00. Bridgework, earthwork and construction work. 115m. 65chs. and 117m. 69chs. Cranes and mechanical equipment in use. (86/18)
220 Wymondham and Trowse Lower Jn	Down and Up	07 30 to 16 00. Signalling work. (85/24)
221 Hethersett and Trowse Lower Jn	Down and Up	07 30 to 16 00. Bridgework (Nos.1638, 1640, 1640A and 349). 121m. 17chs. and 122m. 32chs. (86/22)

SECTION B - TEMPORARY ENGINEERING WORKS - continued

<u>At or between</u>	<u>Lines affected</u>	<u>Remarks</u>
----------------------	-----------------------	----------------

ELY NORTH JN TO TROWSE LOWER JN - continued

SATURDAY/SUNDAY 13/14 SEPTEMBER

222	Attleborough and Wymondham	Down and Up BLOCKED	22'45 to 08 00. Loading materials. Crane and mechanical equipment in use. <u>Possession to be given up for passage of trains.</u>
223	Hethersett and Trowse Lower Jn	Down BLOCKED	23 00 to 16 00. Bridgework (Nos. 1640 and 1640A). 121 $\frac{1}{2}$ m.p. Mechanical equipment in use. <u>Single line working over Up line.</u>

WEDNESDAY 17 TO SATURDAY 20 SEPTEMBER

224	Wymondham and Trowse Lower Jn	Down and Up BLOCKED	23 00 Wed to Fri to 06 30 Thu to Sat. Signalling work. Mechanical equipment in use.
-----	-------------------------------	------------------------	---

THURSDAY/FRIDAY 18/19 SEPTEMBER

225	Brandon and Thetford	Down and Up BLOCKED	23 45 to 06 00. Track maintenance. Mechanical equipment in use.
-----	----------------------	------------------------	---

WYMONDHAM TO NORTH ELMHAM

UNTIL FURTHER NOTICE

226	Wymondham and North Elmham	Single	08 00 to 16 00. Trimming lineside vegetation. $\frac{1}{2}$ and 6m.p. Mechanical equipment in use. (85/31)
-----	----------------------------	--------	---

FENCHURCH STREET TO SHOEBURYNESS

UNTIL FURTHER NOTICE

227	Fenchurch Street Station	All	Construction/demolition work. Mechanical equipment in use. (84/38)
228	Fenchurch Street and Stepney East	All	07 30 to 18 30. Construction work. Mechanical equipment in use. <u>Until 18 30 Sunday 14 September.</u> (85/27)

SECTION B - TEMPORARY ENGINEERING WORKS - continued

<u>At or between</u>	<u>Lines affected</u>	<u>Remarks</u>
<u>FENCHURCH STREET TO SHOEBURYNESSE - continued</u>		
UNTIL FURTHER NOTICE - continued		
228A Fenchurch Street and Stepney East	All	Construction work, and in connection with engineering work (Docklands Light Railway). Mechanical equipment in use. (See Section 'D'). <u>From 00 01 Monday 15 September.</u> (86/25)
229 Fenchurch Street and Gas Factory Jn	All	08 00 to 17 00. Signalling work. (86/1)
230 East Ham	Down and Up	Construction work. Mechanical equipment in use. (83/51)
231 East Ham and Barking (London End)	Down and Up	Erecting scaffolding in connection with bridge No. 66B. (85/8)
232 Leigh-on-Sea and Benfleet	Up	Sea wall work. (85/34)
233 Leigh-on-Sea	Down	09 00 to 16 00. Demolition work. Mechanical equipment in use. (85/60)
234 Westcliff-on-Sea	Down	09 00 to 16 00. Demolition work. Mechanical equipment in use. (85/60)

FRIDAY/SATURDAY 12/13 SEPTEMBER

235 Fenchurch Street	All BLOCKED	21 15 to 06 00. Construction work. Mechanical equipment in use.
236 Fenchurch Street and Gas Factory Jn	All BLOCKED	21 15 to 06 00. Repairs to platform awnings (Stepney East Station), construction work and painting Stepney East Station. <u>Isolation of electrical sections 501, 502, 503 and 504.</u>

SECTION B - TEMPORARY ENGINEERING WORKS - continued

At or between	Lines affected	Remarks
---------------	----------------	---------

FENCHURCH STREET TO SHOEBURYNESS - continued

FRIDAY/SATURDAY 12/13 SEPTEMBER - continued

237	East Ham (London End) and Barking Station	Down and Up Main and Tilbury Connecting line BLOCKED)23 59 to 04 15. Overhead line work) (conversion). Mechanical equipment) in use. <u>Isolation of electrical</u>) <u>sections 510AB, 511DE, 513.</u>)
	Barking Station	Platform 5 (Up Main) BLOCKED)))
238	Barking Station (Country End) and Forest Gate Jn	Up Tilbury/Up and Up Goods Loop BLOCKED to electric trains	23 59 to 04 15. In connection with engineering work. <u>Isolation of</u> <u>electrical sections 513.</u>

SUNDAY 14 SEPTEMBER

239	East Ham (London End) and Barking Station (Country End)	Down and Up Main BLOCKED	00 30 to 17 30. Overhead line work (conversion). Mechanical equipment in use. <u>Isolation of electrical</u> <u>sections 510ABC, 511CDE. Trains</u> <u>diverted via Stratford and Forest</u> <u>Gate Jn and to travel over Tilbury</u> <u>lines.</u>
240	Forest Gate Jn and Barking Station (Country End)	All BLOCKED to electric trains	00 50 to 06 15. In connection with engineering work between Woodgrange Park Jn and Barking Tilbury Line Jn West. <u>Isolation of electrical</u> <u>sections 512 and 513.</u>
241	Laindon	Platform 2 (Reversing Line) BLOCKED	08 00 to 18 00. Painting Laindon Station. <u>Isolation of electrical</u> <u>sections 520B. Trains to be</u> <u>replatformed as necessary.</u>

MONDAY 15 SEPTEMBER

242	Barking and Upminster	Down BLOCKED	01 00 to 04 15. Overhead line line work. <u>Isolation of electrical</u> <u>sections 510E, 514. Down trains</u> <u>diverted via Grays.</u>
-----	--------------------------	-----------------	--

SECTION B - TEMPORARY ENGINEERING WORKS - continued

At or between	Lines affected	Remarks
---------------	----------------	---------

FENCHURCH STREET TO SHOEBURYNESSE - continued

MONDAY 15 TO SATURDAY 20 SEPTEMBER

243	Fenchurch Street	All BLOCKED	21 15 Mon to Fri to 06 00 Tue to Sat. Construction work. Mechanical equipment in use.
244	Fenchurch Street and Gas Factory Jn	All BLOCKED	21 15 Mon to Fri to 06 00 Tue to Sat. Repairs to platform awnings (Stepney East Station), construction work and painting Stepney East Station. <u>Isolation of electrical sections 501, 502, 503 and 504.</u>

UPPER HOLLOWAY TO BARKING, TILBURY LINE JN WEST

UNTIL FURTHER NOTICE

245	Upper Holloway and Crouch Hill Station	Down and Up	Earthwork. 3m 4lchs. and 3m 43chs. Mechanical equipment in use. (85/64)
246	Wanstead Park Station	Up	08 00 to 16 00. Platform work. <u>(See Section 'D')</u> . (85/50)
247	Woodgrange Park and Barking Station Jn	Down and Up <u>Between Trains</u>	07 30 to 18 00. Bridgework (No. 6). 12m. 26chs. Crane and mechanical equipment in use. (85/62)
248	Woodgrange Park and Barking Tilbury Line Jn West	Down and Up	Erecting scaffolding in connection with bridge No. 14A. (85/8)

FRIDAY/SATURDAY 12/13 SEPTEMBER

249	Barking Station (Country End) and Forest Gate Jn	Up Tilbury/Up and Up Goods Loop BLOCKED to electric trains	23 59 to 04 15. In connection with engineering work. <u>Isolation of electrical sections 513.</u>
-----	--	---	---

SECTION B - TEMPORARY ENGINEERING WORKS - continued

At or between	Lines affected	Remarks
---------------	----------------	---------

UPPER HOLLOWAY TO BARKING, TILBURY LINE JN WEST - continued

SUNDAY 14 SEPTEMBER

250	Forest Gate Jn and Barking Station (Country End)	All BLOCKED to electric trains	00 50 to 06 15. In connection with engineering work between Woodgrange Park Jn and Barking Tilbury Line Jn West. <u>Isolation of electrical sections 512 and 513.</u>
251	Woodgrange Park Jn and Barking Tilbury Line Jn West	Down and Up BLOCKED	00 50 to 06 15. Bridgework (No. 14A). Crane and mechanical equipment in use. <u>Possession to be given up for passage of Engineers' trains.</u>

BARKING, TILBURY LINE JN EAST TO TILBURY RIVERSIDE

UNTIL FURTHER NOTICE

252	Dagenham Dock Station	Down and Up	08 00 to 17 00. Construction work. Mechanical equipment in use. (85/14)
253	Rainham Station	Down and Up	08 00 to 17 00. Construction work. Mechanical equipment in use. (85/14)
254	Purfleet Station	Down and Up	09 00 to 16 00. Platform work. Mechanical equipment in use. (85/61)

SUNDAY 14 SEPTEMBER

255	Barking Tilbury Line Jn East and West Thurrock Jn	All BLOCKED	00 35 to 07 00. Track maintenance. 13m. 48chs. and 13m. 58chs.
256	Grays and Tilbury Riverside/ Tilbury East Jn	All BLOCKED	01 00 to 21 45. Track maintenance, track renewal and overhead line work. Crane and mechanical equipment in use. <u>Possession to be given up for passage of OM52 21 00 Ripple Lane to Tilbury RCT.</u>
257	Grays and Pitsea	All BLOCKED to electric trains	01 00 to 21 45. In connection with engineering work. <u>Isolation of electrical sections 532H, 533A, 534, 535, 536 and 537.</u>

SECTION B - TEMPORARY ENGINEERING WORKS - continued

<u>At or between</u>	<u>Lines affected</u>	<u>Remarks</u>
<u>TILBURY WEST JN TO TILBURY EAST JN</u>		
SUNDAY 14 SEPTEMBER		
258 Grays and Tilbury Riverside/ Tilbury East Jn	All BLOCKED	01 00 to 21 45. Track maintenance, track renewal and overhead line work. Crane and mechanical equipment in use. <u>Possession to be given for passage of OM52 21 00 Ripple Lane to Tilbury RCT.</u>
259 Grays and Pitsea	All BLOCKED to electric trains	01 15 to 21 45. In connection with engineering work. <u>Isolation of electrical sections 532H, 533A, 534, 535, 536 and 537. TILBURY RIVERSIDE TO PITSEA</u>
<u>TILBURY RIVERSIDE TO PITSEA</u>		
SUNDAY 14 SEPTEMBER		
260 Grays and Pitsea	All BLOCKED to electric trains	01 15 to 21 45. In connection with engineering work. <u>Isolation of electrical sections 532H, 533A, 534, 535, 536 and 537.</u>
, SUNDAY 14 TO MONDAY 15 SEPTEMBER		
261 Thames Haven Jn and Pitsea	All BLOCKED	01 10 Sun to 02 30 Mon. Level crossing work (Fobbing LC) and overhead line work. Mechanical equipment in use. <u>21 45 Sun to 02 30 Mon Isolation of electrical sections 536 and 537.</u>

SECTION C

SIGNALLING AND PERMANENT WAY ALTERATIONS

* * Items marked thus will not appear in future issues and a note must be
* taken of them by all concerned.

DETAILS OF WORK REFERRED TO IN SECTION B

SUNDAY 14 SEPTEMBER - SNAILWELL (Between Chippenham Junction and Soham)

A new trailing connection will be brought into use in the Up line at 3m.p. leading to Firmin Coates Private Siding.

Operation will be by two-lever ground frame released from Chippenham Junction signalbox. (Telephone communication will be provided between the ground frame and signalbox).

(28)

DETAILS OF WORK ALREADY CARRIED OUT

NEW HALL

The Up Loop has been taken out of use Until Further Notice.

(UFN)

HATFIELD PEVEREL

The facing and trailing crossovers are out of use until further notice.

(UFN)

* * MARKS TEY

*

The Branch Starting signal has been repositioned 212 yards nearer to Marks Tey Station Platform on a shorter post, 11ft. 6ins. above rail level.

The Branch Home Signal has been renewed in its existing position on a shorter post, 11ft. 6ins. above rail level.

(25)

* * BETWEEN TROWSE SWING BRIDGE AND NORWICH STATION

*

The Up Main line has been slued to a new alignment nearer to the Down Main.

(25)

SECTION C - SIGNALLING AND PERMANENT WAY ALTERATIONS - continuedDETAILS OF WORK ALREADY CARRIED OUT - continuedTHORPE JUNCTION

The lines leading into Line 'C' (Up Main) at Thorpe Junction have been remodelled resulting in Line 'B' (Up Lowestoft) and Nos. 1 and 2 Receptions being realigned.

- The Headshunt associated with Nos. 1 and 2 Reception lines has been abolished.

(27)

THORPE JUNCTION AND NORWICH STATION

An elevated double-sided "OFF" indicator plated NO 1785/1787R has been provided on the left-hand side of line 'A'/'E', 80 yards on the Whitlingham Junction side of Carrow Road Bridge.

The indication 'OFF' will be illuminated when either position light signal NO 1785 (Line 'C') or NO 1787 (Line 'E') has been cleared.

(27)

SECTION D

GENERAL INSTRUCTIONS AND NOTICES

A thick vertical line denotes new or amended items.

** Items marked thus will not appear in future issues and a note must be taken of them by all concerned.
*

EASTERN REGION SECTIONAL APPENDIX (SOUTHERN AREA)

TABLE A : DETAILS OF RUNNING LINES

Running Lines and Signalling System	Location	M. Ch.	Permanent Speed Restrictions		Remarks
			Down m.p.h.	Up m.p.h.	
<u>LIVERPOOL STREET TO NORWICH</u>					
<u>Page 60</u>					
<u>Delete:-</u>	Ardley End LC	97 00			
<u>Substitute :-</u>	Audley End (Norfolk) LC (AHB-X)	97 05	X50	X50	<u>Approaching level crossing in wrong direction.</u>
					(10.SD)
<u>WICKFORD JN. TO SOUTHMINSTER</u>					
<u>Page 68 (Page 20, SD.PON)</u>					
At Southminster					
<u>Add:-</u>			15	15	<u>45m. 23chs. and 45m. 42chs.</u>
					(10.SD)

SE-44

SECTION D - GENERAL INSTRUCTIONS AND NOTICES - continued

EASTERN REGION SECTIONAL APPENDIX (SOUTHERN AREA) - continued.

Running Lines and Signalling System	Location	M. Ch.	Permanent Speed Restrictions		Remarks
			Down m.p.h.	Up	
<p><u>NORWICH TO LOWESTOFT</u></p> <p><u>Page 78</u> (Page A44, SD PON)</p> <p><u>Delete</u> all details between Norwich Thorpe Jn and Whitlingham Jn and <u>substitute</u> :-</p>					
<p>Line W Line C Line E Line B Line A</p>	Norwich	0 00	15		<u>All lines. 0m.p. and 0m. 38chs.</u>
	Norwich (NO)	0 23			Norwich (NO) signal box area between Norwich and Crown Point.
	Thorpe Jn (See page 61)	0 29			

SECTION D - GENERAL INSTRUCTIONS AND NOTICES - continued

EASTERN REGION SECTIONAL APPENDIX (SOUTHERN AREA) - continued

Running Lines and Signalling System	Location	M. Ch.	Permanent Speed Restrictions		Remarks
			Down m.p.h.	Up At or Between	
<p><u>NORWICH TO LOWESTOFT - continued</u></p> <p><u>Page 78 (Page A44, SD PON) - continued</u></p> <p><u>Delete</u> all details between Norwich Thorpe Jn and Whitlingham Jn and <u>substitute - continued :-</u></p>					
		0 35			
	Crown Point	0 60		15	<u>All lines. Om. 38chs. and Om.p.</u>
	Whitlingham Jn (WH) (See page 79)	1 69	<u>25</u>		<u>To Cromer line.</u>

SECTION D - GENERAL INSTRUCTIONS AND NOTICES - continued

EASTERN REGION SECTIONAL APPENDIX (SOUTHERN AREA) - continued

Running Lines and Signalling System	Location	M. Ch.	Permanent Speed Restrictions		Remarks
			Down m.p.h.	Up m.p.h.	
<u>Page 81</u>					
<u>REEDHAM JN TO YARMOUTH</u>					
At Berney Arms					
<u>Delete :-</u>			30	30	<u>15m.p. and 19m. 24chs.</u>
<u>Substitute :-</u>			30	30	<u>13m. 52chs. and 19m. 24chs.</u>
					(10.SD)

SE-47

SECTION D - GENERAL INSTRUCTIONS AND NOTICES - continuedEASTERN REGION SECTION APPENDIX (SOUTHERN AREA) - continuedOTHER GENERAL INSTRUCTIONSPage 297Add :- DOCKLANDS LIGHT RAILWAY LINE BETWEEN BOW JN AND STRATFORD STATION
(ADJACENT TO THE B.R. UP ELECTRIC LINE)

B.R. staff must observe the provisions of the previous instructions on pages 294 to 297 headed, "Instructions to Traincrews Working other than D.C. Electric trains and other staff concerned working over or in the vicinity of D.C. Electrified lines", except that reference to Electrical Control Operator should be read as Controller and Supervisor at Poplar Control Centre, who can be contacted via the Signaller at Bow Jn or on British Telecom 538 3440.

The Docklands Light Railway when fully operational will work automatically without lineside signals, using Driverless trains which will approach in either direction travelling at a maximum speed of 50m.p.h. Each train will convey a member of Docklands Light Railway staff called a "Train Captain".

Docklands trains will not sound a warning to persons on or near the line, etc. and B.R. Staff must not, therefore, except in emergency go onto the Docklands Light Railway. Posts are provided in the 10 Foot between the Up Electric line and the Docklands line to identify the point beyond which staff must not proceed. When staff stand clear of the Up Electric line they must align themselves between the posts.

In the vicinity of the Bow Junction signal box and overbridge 609 (Fairfield Road), Staff must not, except in emergency, proceed beyond the fence between the B.R. and Docklands line. If unavoidable circumstances compel staff to remain between the B.R. and Docklands lines when trains pass, they must lay down against the B.R. side of the fence. It is important that this instruction is observed as the collector shoes of Docklands Light Railway trains will pass in close proximity to the Docklands side of the fence.

If an emergency/mishap occurs on B.R. lines requiring the stopping of trains on the Docklands Light Railway, standard B.R. protection arrangements must be observed and advice given to the Poplar Control Centre by the quickest available means. It should be noted that the placing of a Track Circuit Operating Clip on the Docklands line will stop a train which is in automatic mode.

(10.SD)

SECTION D - GENERAL INSTRUCTIONS AND NOTICES - continuedEASTERN REGION SECTIONAL APPENDIX (SOUTHERN AREA) - continuedLOCAL INSTRUCTIONSINDEXPage 301

Page

Add:-

Oulton Broad South and Beccles - Between

322

LOCAL INSTRUCTIONSPage 322EAST SUFFOLK JN TO OULTON BROAD NORTH JNAdd:-BETWEEN OULTON BROAD SOUTH AND BECCLES

2J49 16 25 Lowestoft-Beccles train is authorised to proceed from Oulton Broad South to Beccles and return from that location to Oulton Broad South displaying the Oulton Broad South to Halesworth Full token throughout.

The Driver must obtain the permission of the Signalman at Saxmundham for the train to return from Beccles to Oulton Broad South. The token now being displayed in the rear cab.

On arrival at Oulton Broad South, the Driver must proceed to the rear cab, carry out the token return procedure and then proceed forward in the normal manner.

(10.SD)

Page 316SILVERTOWNDelete instruction and substitute :-Thomas W. Ward and Co. Private Siding

Loaded or empty 4-wheeled vehicles with a wheelbase exceeding 10' 6" (3.2m) (with the exception of POA vehicles), 80 to 100t AB 4-axled bogie vehicles and 6-wheeled vehicles must not be taken into this private siding.

POA 51t GLW open scrap wagons may be worked singly into this siding at dead slow speed, but only so far as the firms' wagon weighbridge for weighing purposes.

BCV, BDV, BEV, BPV and BQV's must be shunted into this siding at dead slow speed.

(10.SD)

SECTION D - GENERAL INSTRUCTIONS AND NOTICES - continuedMISCELLANEOUS NOTICESBETWEEN STEPNEY EAST AND FENCHURCH STREET

Commencing Monday 5 September, staff of the Docklands Light Railway will be laying in track adjacent to the Up Main/Slow line between Stepney East Station (1m. 58chs.) and Fenchurch Street. Restricted clearances exist and Drivers must keep a sharp look out and be prepared to sound the warning horn as necessary.

(UFN)

* * ALTERATIONS TO WORKING MANUAL FOR RAIL STAFF (B.R.30054)
* PART 2 - GREEN PAGES

A complete re-issue of Part 2 (Green Pages) of the Working Manual For Rail Staff is currently being distributed (dated 1 September 1986).

In the event of non-receipt, staff and offices entitled to receive these pages should contact their normal distribution point.

(25)

WORKING OF CLASS 313 AND CLASS 416 ELECTRIC MULTIPLE UNIT
TRAINS BETWEEN DALSTON WESTERN JN AND STRATFORD MARKET

Class 313 Electric Multiple Units

These units must only work between Navarino Road Jn and Stratford Market stabling sidings when either the Graham Road Curve route to Liverpool Street is not available, or when the pantographs have failed to rise. When operating between Dalston Kingsland and Stratford Market stabling sidings and return in the D.C. mode, Drivers must not advance the controller beyond Notch 2.

THESE UNITS MUST NOT RUN BEYOND STRATFORD MARKET TOWARDS NORTH WOOLWICH.

Class 416 Electric Multiple Units

Not more than two Class 416 units may be coupled together.

When two Class 416 units are running in multiple between Dalston Western Jn and Stratford Market, including the stabling sidings or return, Drivers must not advance the controller beyond Notch 2.

(UFN)

BETHNAL GREEN STATION

Until Further Notice, whilst demolition work is taking place, Drivers of 4-Car EMU trains must stop their trains at the temporary stop boards provided.

(UFN)

SECTION D - GENERAL INSTRUCTIONS AND NOTICES - continuedMISCELLANEOUS NOTICES - continuedDALSTON (KINGSLAND) STATION

The Down and Up platforms have been temporarily shortened at the Stratford end by 25 yards and only accommodate two coaches. Drivers of Down trains booked to stop at this station must bring their train to a stand at signal DW14/16. Drivers of Up trains booked to stop at this station must bring their train to a stand at the temporary stop board which has been provided adjacent to the footbridge.

(LM) (UFN)

HARWICH PARKESTON QUAY STATION

Until Further Notice, reconstruction work on Platform 2 will create hazards for passengers, including sub-standard surfaces and larger than normal gaps between the platform and train.

Special warning notices are to be exhibited and best use made of on-train and station announcing facilities to warn the Public of the danger.

(UFN)

CAMBRIDGE HEATH STATION

Whilst platform repairs are taking place, Drivers of trains must stop their trains at the temporary stop boards provided.

(UFN)

SAWBRIDGEWORTH STATION

The stop board on the Up platform has been temporarily moved 9 yards towards the Country side of its former position.

(UFN)

WANSTEAD PARK STATION

Whilst platform repairs are taking place, Drivers of Up trains must stop their trains at the temporary stop boards provided.

(UFN)

SECTION D - GENERAL INSTRUCTIONS AND NOTICES - continuedMISCELLANEOUS NOTICES - continuedREPAIRS IN MOTIVE POWER DEPOTS, CARRIAGE SHEDS, WAGON REPAIR SHEDS AND WAREHOUSES

In connection with work being carried out at the undermentioned places, scaffolding or projections may be provided or unusual excavations may be made in the ground:-

Location	Nature of Work	Duration	Commencing date
Thornton Field Carr. M.D., All lines BLOCKED to electric trains	In connection with engineering work. <u>Isolation of electrical sections 433.</u>	<u>From 23 30 Friday 19 until 03 45 Saturday 20 September.</u>	-
Stratford Old Yard C.H.S., All lines BLOCKED to electric trains	In connection with engineering work. <u>Isolation of electrical sections 433.</u>	<u>From 23 30 Friday 19 until 03 45 Saturday 20 September.</u>	-
Stratford T.M.D. All lines.	Repairs to Motive Power Depot. Cranes and mechanical equipment in use.	Continuously. Until Further Notice.	-
Ilford EMU Depot, Nos. 19 and 20 Roads.	Drainage.	08 00 to 17 00 daily. Until Further Notice.	-
Ilford EMU Depot, Carriage Washer Roads BLOCKED	Renewal of carriage washer plant. <u>Isolation of electrical sections 361R.</u>	Continuously. Until Further Notice.	-
Gidea Park CS, Nos. 1 to 5 inc. Sidings BLOCKED to electric trains	Construction work, <u>Isolation of electrical sections 326DE.</u>	00 10 to 05 15 daily.	<u>From Tuesday 16 until Friday 19 September.</u>

SECTION D - GENERAL INSTRUCTIONS AND NOTICES - continuedMISCELLANEOUS NOTICES - continuedREPAIRS IN MOTIVE POWER DEPOTS, CARRIAGE SHEDS, WAGON REPAIR SHEDS AND WAREHOUSES - continued

In connection with work being carried out at the undermentioned places, scaffolding or projections may be provided or unusual excavations may be made in the ground:-

Location	Nature of Work	Duration	Commencing date
Norwich Crown Point T & R.S. M.D., All lines BLOCKED	Construction work (overhead line) and track maintenance. Mechanical equipment in use. <u>Possession to be given up for passage of trains.</u>	08 00 to 17 00 daily. Until further notice.	-
East Ham EMU Depot, All lines.	Shed reconstruction.	Continuously. Until Further Notice.	-
East Ham EMU Depot, Washer Road BLOCKED	Repairs to washer plant. <u>Isolation of electrical sections 509A.</u>	Continuously. Until Further Notice.	-
East Ham EMU Depot, All lines BLOCKED	Overhead line work. <u>Isolation of electrical sections 509.</u>	00 30 to 17 30. <u>Sunday 14 September.</u>	-

MP.32/SE
YORK
4 SEPTEMBER, 1986

C. McKEEVER
Regional Operations Manager

BRITISH RAIL
EASTERN REGION

SE

26

WEEKLY OPERATING NOTICE

CONTAINING

TEMPORARY SPEED RESTRICTIONS

TEMPORARY ENGINEERING WORKS

SIGNALLING AND
PERMANENT WAY ALTERATIONS

GENERAL INSTRUCTIONS AND NOTICES

SATURDAY 20 SEPTEMBER

TO

FRIDAY 26 SEPTEMBER 1986

INCLUSIVE

Trainmen must pay particular attention to works contained in this notice and keep a good look-out for handsignals which may be exhibited in accordance with the Rules and Regulations.

Work at places other than those mentioned may be in progress and Drivers must be on the look-out and be prepared to stop or run at reduced speed when, and where, handsignals may be exhibited.

SECTION A

TEMPORARY SPEED RESTRICTIONS

(Until further notice unless otherwise specified)

Warning Boards and Indicators provided unless otherwise shown.

† Indicates that the Warning Boards and Indicators will be moved as the work progresses. Where two speeds are shown for a restriction e.g. $\frac{20}{40}$ the Rule Book, Section U, Clause 1.2 applies.

Location	Lines affected		Mileage		Restr- iction	Remarks
			M. Ch. M.	M. Ch. M.		
<u>LIVERPOOL STREET TO NORWICH</u>						
1 Bow Jn and Bethnal Green Station Jn	-	Up Main	1 70	1 60	30	Trackwork. (86/24) <u>Until 11 00</u> <u>Sunday 21</u> <u>September</u>
2 Ilford Car Sheds and Goodmayes Station	Down Main	-	8 37	8 55	20	Trackwork. <u>Warning board</u> <u>also provided</u> <u>on Down</u> <u>Electric</u> <u>line at 7m.</u> <u>72chs.</u> (86/23)
3 Goodmayes Station and Ilford Car Sheds	-	Up Main	8 55	8 37	20	Trackwork. <u>Warning board</u> <u>also provided</u> <u>on Up</u> <u>Electric</u> <u>line at 9m.</u> <u>23chs.</u> (86/23)
4 Romford and Gidea Park Station	Down Electric	Up Electric	12 15	12 48	20	Trackwork. (86/24)
5 Harold Wood and Brentwood	Down Main	-	15 02	15 42	$\frac{20}{40}$	Condition of track. (85/61)
6 Brentwood and Ingatestone	Down Main	-	19 65	20 33	50	Condition of track. (86/14)

SECTION A - TEMPORARY SPEED RESTRICTIONS - continued

Location	Lines affected	Mileage at or between				Restr- iction m.p.h.	Remarks	
		M.	Ch.	M.	Ch.			
<u>LIVERPOOL STREET TO NORWICH - continued</u>								
7 Church Lane LC and Chelmsford	Down	Up	29	24	29	57	20	Trackwork. <u>From 14 00</u> <u>Friday 26</u> <u>September.</u> (86/26)
8 Chelmsford and New Hall G.F.	Down	-	30	50	30	65	50	Condition of track. (86/12)
9 New Hall G.F. and Hatfield Peverel	Down	-	34	50 †	35	20	40	Trackwork. (86/25) <u>Until 10 00</u> <u>Monday 22</u> <u>September.</u>
10 New Hall G.F. and Hatfield Peverel	Down	-	35	10 †	35	40	40	Trackwork. (86/26) <u>From 10 00</u> <u>Monday 22</u> <u>September.</u>
11 Hatfield Peverel - and New Hall G.F.	-	Up	34	27	34	22	40	Earthwork. <u>From 09 00</u> <u>Monday 22</u> <u>until 14 00</u> <u>Friday 26</u> <u>September.</u>
12 New Hall G.F. and Witham	Down	-	35	20 †	38	40	60	Trackwork. (86/25) <u>Until 10 00</u> <u>Monday 22</u> <u>September.</u>
13 New Hall G.F. Witham	Down	-	35	40 †	38	40	60	Trackwork. (86/26) <u>From 10 00</u> <u>Monday 22</u> <u>September.</u>
14 Kelvedon	-	Up	42	25	42	10	<u>50</u> <u>80</u>	Condition of track. (86/7)

SECTION A - TEMPORARY SPEED RESTRICTIONS - continued

Location	Lines affected	Mileage at or between		Restr- iction m.p.h.	Remarks
		M. Ch.	M. Ch.		
<u>LIVERPOOL STREET TO NORWICH - continued</u>					
15 Long Green LC and Marks Tey Jn	Down	-	46 36	46 55	20 Earthwork. (86/23)
16 Marks Tey Jn and Long Green LC	-	Up	46 55	46 36	30 Earthwork. From 07 00 <u>until 16 00</u> <u>Sunday 21</u> <u>September.</u>
17 Barham and Baylham LC	Down	Up	74 70	75 05	30 Bridgework. (No. 262). From 22 00 <u>Saturday 20</u> <u>September.</u> (86/26)
18 Diss and Audley End LC	Down	Up	95 10	95 15	20 Bridgework (No. 315). From 22 00 <u>Saturday 20</u> <u>September.</u> (86/26)
19 Swainsthorpe and Trowse Lower Jn	Down	Up	112 30	112 70	30 Trackwork. From 09 00 <u>Thursday 25</u> <u>September.</u> (86/26)

SHENFIELD JN TO SOUTHEND VICTORIA

20 Billericay and Wickford Station	Down	-	26 10	26 44	40 Condition of track. (86/14)
21 Wick Lane LC and Rayleigh	Down	-	31 35	31 75	40 Condition of embankment. (84/41)

WICKFORD JN TO SOUTHMINSTER

22 Althorne LC and Burnham-on- Crouch	Single		41 10 †	42 10	20 Trackwork. (85/45)
---	--------	--	---------	-------	--------------------------

SECTION A - TEMPORARY SPEED RESTRICTIONS - continued

Location	Lines affected	Mileage at or between				Restr- iction m.p.h.	Remarks
		M.	Ch.	M.	Ch.		
<u>COLCHESTER TO CLACTON</u>							
23 Wivenhoe and Thorrington LC	Down	-		57 12 †	58 54	30	Trackwork. From 07 00 Until 16 00 Sunday 21 September.
24 Thorrington LC and Wivenhoe	-	Up		58 54 †	57 12	20	Trackwork. From 23 00 Saturday 20 September. (86/26)
<u>MANNINGTREE SOUTH JN TO HARWICH</u>							
25 Bradfield LC and Wrabness	Down	-		63 37	63 39	40	Earthwork. (85/55)
26 Parkeston Goods Jn and Wrabness	-	Up		66 70	66 10	$\frac{30}{50}$	Condition of track. (86/3)
<u>EAST SUFFOLK JN TO OULTON BROAD NORTH JN</u>							
27 Bealings LC and Westerfield Jn	-	Up		74 60 †	73 44	20	Trackwork. (86/21)
28 Darsham and Middleton LC	-	Up		94 56	94 54	30	Trackwork. From 22 00 Saturday 20 until 15 00 Thursday 25 September.
<u>NORWICH TO LOWESTOFT</u>							
29 Thorpe Jn and Whitlingham Jn	Down	Up		0 36	0 44	20	Trackwork. (85/20)
<u>BETHNAL GREEN JN TO KING'S LYNN</u>							
30 Cambridge Heath	Down Suburban	Up Suburban		1 57	1 67	20	Platform work. (86/24)

SECTION A - TEMPORARY SPEED RESTRICTIONS - continued

Location	Lines affected		Mileage		Restr- iction m.p.h.	Remarks
			at M.	or between Ch. M. Ch.		
BETHNAL GREEN JN TO KING'S LYNN - continued						
31 Brimsdown and Waltham Cross	Down	Up	11 54	12 12	20	Trackwork. (86/11)
32 Cheshunt Station and Wharf Road LC	Down	-	15 12 †	15 79	40	Trackwork. From 10 00 <u>Wednesday 24</u> <u>September.</u> (86/26)
33 Slipe Lane LC and Cheshunt Station	-	Up	15 55	15 35	50	Condition of track. (86/4) <u>Until 10 00</u> <u>Wednesday 24</u> <u>September.</u>
34 Wharf Road LC and Cheshunt Station	-	Up	15 79 †	15 12	30	Trackwork. <u>From 10 00</u> <u>Wednesday 24</u> <u>September.</u> (86/26)
35 Broxbourne Jn and Roydon	Down	Up	19 43 †	20 05	20	Trackwork. (86/19) <u>Until 14 00</u> <u>Monday 22</u> <u>September.</u>
36 Harlow Mill and Sawbridgeworth	Down	-	24 60	24 76	20	Trackwork. <u>From 00 01</u> <u>Sunday 21</u> <u>until 10 00</u> <u>Wednesday 24</u> <u>September.</u>
37 Sawbridgeworth and Harlow Mill	-	Up	24 76	24 70	60	Condition of track. (86/16)
38 Whittlesford Station	Down Main	-	49 00	49 10	40	Platform work. (86/21) <u>Until 14 00</u> <u>Friday 26</u> <u>September.</u>

SECTION A - TEMPORARY SPEED RESTRICTIONS - continued

Location	Lines affected	Mileage		Restr- iction m.p.h.	Remarks
		at or between M. Ch. M. Ch.			
<u>BETHNAL GREEN JN TO KING'S LYNN - continued</u>					
39 Chesterton Jn and Milton Fen LC	Down	Up	58 63 58 67	20	Bridgework (No. 1550B). (86/24) <u>Until 00 01</u> <u>Sunday 21</u> <u>September.</u>
40 Chesterton Jn and Milton Fen LC	Down	Up	58 63 58 67	60	Bridgework (No. 1550B). <u>From 00 01</u> <u>Sunday 21</u> <u>until 15 00</u> <u>Wednesday 24</u> <u>September.</u>
<u>COLDHAM LANE JN TO HAUGHLEY JN</u>					
41 Bury St. Edmunds and Thurston	Down	-	31 20 31 50	40	Trackwork. (86/18) <u>Until 10 00</u> <u>Monday 22</u> <u>September.</u>
42 Elmswell and Haughley Jn	Down	-	37 15 † 38 00	20	Trackwork. (86/22)
<u>ELY NORTH JN TO PETERBOROUGH, CRESCENT JN</u>					
43 Third Drove LC and Welney Road LC	Down	Up	78 00 78 18	20	Condition of track. (86/21)
44 Third Drove LC and Welney Road LC	Down	Up	78 42 78 60	20	Condition of track. (86/21)

SECTION A - TEMPORARY SPEED RESTRICTIONS - continued

Location	Lines affected		Mileage		Restr- iction	Remarks
			at or between	M. Ch. M. Ch. m.p.h.		
<u>ELY NORTH JN TO PETERBOROUGH, CRESCENT JN - continued</u>						
45 March East Jn and Badgeney Road LC	-	Up Main	85 40	85 29	20	Trackwork. (85/54) <u>Warning board</u> <u>positioned at</u> <u>signal ME.45.</u> <u>Additional</u> <u>warning board</u> <u>provided on</u> <u>the March</u> <u>East Jn to</u> <u>Wisbech line,</u> <u>positioned at</u> <u>signal ME.52.</u>
46 Three Horse Shoes No. 3 LC	Down	Up	90 74	90 78	<u>20</u> 50	Condition of track. (86/24)

Warning board at 100m. 23chs. (on the Down line) applies only to trains proceeding over the Two-Way Goods line to Fly Ash Inspection Siding connection at Peterborough Station (North).

ELY NORTH JN TO TROWSE LOWER JN

47 Eaton LC and Trowse Lower Jn	Down	Up	121 60	121 64	20	Bridgework (Nos. 1640 and 1640A). (86/23)
------------------------------------	------	----	--------	--------	----	--

UPPER HOLLOWAY TO BARKING, TILBURY LINE JN WEST

48 South Tottenham East Jn and Black Horse Road	Down	-	6 45	6 57	20	Condition of track. (85/18)
---	------	---	------	------	----	-----------------------------------

BARKING, TILBURY LINE JN EAST TO TILBURY RIVERSIDE

49 Jurgens LC and West Thurrock Jn	Down	Up	17 20	17 30	20	Trackwork. From 00 30 <u>Sunday 21</u> <u>September.</u> (86/26)
---------------------------------------	------	----	-------	-------	----	--

SECTION A - TEMPORARY SPEED RESTRICTIONS - continued

Location	Lines affected	Mileage at or between				Restr- iction m.p.h.	Remarks	
		M.	Ch.	M.	Ch.			
<u>TILBURY RIVERSIDE TO PITSEA</u>								
50 Stanford-le- Hope and Gardners LC	Down	-	30	11	30	60	40	Condition of track. (86/1)

SECTION B

TEMPORARY ENGINEERING WORKS

At or between	Lines affected	Remarks
<u>LIVERPOOL STREET TO NORWICH</u>		
UNTIL FURTHER NOTICE		
51 Liverpool Street Station	Platforms 1 to 10 Inc.	Repairs to station roof. Mechanical equipment in use. (84/41)
52 Liverpool Street Station	Platforms 1 to 18 inc.	Cleaning track. (85/21)
53 Liverpool Street Station	Platforms 8, 10 and 11 to 18 inc.	Platform work and construction work. Mechanical equipment in use. (86/21)
54 Bethnal Green Station	Down Main and Down and Up Suburban	08 00 to 16 00. Demolition work. (See Section 'D'). (85/41)
55 Bethnal Green and Bow Jn	All	Signalling work. (86/25)
56 Stratford and Bow Jn	Up Electric	07 30 to 18 00. Construction work. Mechanical equipment in use. (85/62)
57 Forest Gate Jn and Ilford	All	07 00 to 18 00. Bridgework (No. 75A), 7m. 08chs. Mechanical equipment in use. (85/20)
58 Ilford Station	All	08 00 to 17 00. Repairs to station roof and painting station. (86/2)
59 Romford Jn and Gidea Park	All	Bridgework (No. 102B). 12m. 48chs. Crane and mechanical equipment in use. (85/54)
60 Ingatestone and Chelmsford	Down and Up	07 30 to 18 00. Construction of bridge (No. 143A) 26m. 51chs. Mechanical equipment in use. (84/35)
61 Chelmsford and Hatfield Peverel	Down and Up	07 30 to 16 00. Earthwork 35m. 53chs. (85/27)
62 Colchester Jn and Ardleigh LC	Down Main	08 00 to 17 00. Earthwork and formation renewal. 52m. 25chs. and 53m. 75chs. Mechanical equipment in use. (85/41)

SECTION B - TEMPORARY ENGINEERING WORKS - continued

<u>At or between</u>	<u>Lines affected</u>	<u>Remarks</u>
<u>LIVERPOOL STREET TO NORWICH - continued</u>		
UNTIL FURTHER NOTICE - continued		
63 Manningtree North Jn and Bentley LC	Down and Up <u>Between Trains</u>	07 00 to 18 00. Tree felling, bridgework (No. 229) and earthwork. 60m. 06chs. and 61m. 06chs. Crane and mechanical equipment in use. (85/15)
64 Ipswich Goods Jn and Needham Market	Down Main	08 00 to 16 00. Construction work. 69% and 76m.p. (86/19)
65 East Suffolk Jn and Claydon LC	Down and Up	08 00 to 16 00. Bridgework (No.254A). 70m. 17chs. (85/58)
66 Mellis	Down and Up	07 30 to 18 00. Demolition work. 91%mp. Mechanical equipment in use. (86/12)
67 Mellis and Trowse Lower Jn	All <u>Between Trains</u>	07 30 to 18 00. Signalling work. Points and signals disconnected. (86/15)
68 Diss and Mellis	Up	08 00 to 15 00. Construction work. 94m. 05chs. and 94m.p. (86/17)
69 Diss	Down and Up	07 00 to 19 00. Earthwork. Crane and mechanical equipment in use. (85/27)
70 Diss and Audley End LC	Down and Up	Bridgework (No. 315). 95m. 29chs. (86/16)
71 Diss and Tivetshall Jn	Down and Up	07 30 to 18 00. Demolition work 97m 50chs. Mechanical equipment in use. (86/12)
72 Gissing LC	Down and Up	08 00 to 16 00. Level crossing road repairs. 98m. 56chs. Mechanical equipment in use. (86/26) <u>From 08 00 Monday 22 September.</u>
73 Tivetshall Jn	Down and Up	07 30 to 18 00. Demolition work. 100%mp. Mechanical equipment in use. (86/8)

SECTION B - TEMPORARY ENGINEERING WORKS - continued

At or between	Lines affected	Remarks
---------------	----------------	---------

LIVERPOOL STREET TO NORWICH - continued

UNTIL FURTHER NOTICE - continued

74	Tivetshall Jn and Swainsthorpe	Down and Up <u>Between Trains</u>	07 30 to 18 00. Bridgework (Nos. 328 and 331A) and demolition work. 103m. 13chs. and 104m. 59chs. Crane and mechanical equipment in use. (86/8)
75	Newton Flotman LC	Down and Up	08 00 to 16 00. Level crossing road repairs. 108m. 17chs. Mechanical equipment in use. (86/26) <u>From 08 00 Monday 22 September.</u>
76	Swainsthorpe	Down and Up <u>Between Trains</u>	07 30 to 18 00. Demolition work. 109 $\frac{1}{2}$ m.p. Mechanical equipment in use. (86/8)
77	Swainsthorpe and Trowse Upper Jn.	Down and Up	07 00 to 16 00. Bridgework (No. 346) 110m. 62chs. Mechanical equipment in use. (86/25)
78	Trowse Lower Jn and Norwich Station	All <u>Between Trains</u>	07 00 to 17 00. Construction work (overhead line), earthwork, track maintenance and signalling work. Points and signals disconnected. (86/7)
79	Trowse Swing Bridge	Down and Up <u>Between Trains</u>	Bridgework (No. 356). 123m. 36chs. Crane and mechanical equipment in use. (85/33)
80	Trowse Swing Bridge and Thorpe Jn	Down and Up <u>Between Trains</u>	07 30 to 18 00. Construction work. 123 $\frac{1}{2}$ m.p. Crane and mechanical equipment in use. (86/3)
81	Norwich Station	All	Track renewal, platform work and earthwork. Crane and mechanical equipment in use. (85/62)

FRIDAY/SATURDAY 19/20 SEPTEMBER

82	Bethnal Green and Stratford (London End)	Down and Up Electric BLOCKED	23 00 to 05 00. Overhead line work. Mechanical equipment in use. <u>Isolation of electrical sections 309A, 310B. Trains to travel over Main lines.</u>
----	--	------------------------------------	---

SECTION B - TEMPORARY ENGINEERING WORKS - continued

At or between	Lines affected	Remarks
---------------	----------------	---------

LIVERPOOL STREET TO NORWICH - continued

FRIDAY/SATURDAY 19/20 SEPTEMBER - continued

83	Bow Jn and Stratford	Down Cambridge and Carriage Roads 'A' and 'B'/Down and Up Goods BLOCKED to electric trains	23 30 to 03 45. In connection with engineering work (repairs to signal gantry). <u>Isolation of electrical sections 432AB, 433.</u>
----	----------------------	---	---

SATURDAY 20 SEPTEMBER

84	Thorpe Jn	'A'/'E' line	21 00 to 22 00. Signalling work.
----	-----------	--------------	----------------------------------

SATURDAY 20 TO SUNDAY 21 SEPTEMBER

85	Chadwell Heath Jn and Gidea Park Station Jn	Down and Up Electric BLOCKED to electric trains	20 30 to 21 15 Sat)Track renewal,)formation)renewal, track)maintenance,)undertrack
		Down and Up Electric BLOCKED	21 15 Sat to 22 00 Sun)excavation and)overhead line)work.)Mechanical)equipment in)use. <u>Isolation)of electrical)sections 325DE,)326AB.)20 30 to 21 15)Sat. Electric)trains to)travel over)Main lines.)21 15 Sat to)22 00 Sun.)Trains to)travel over)Main lines.</u>

SECTION B - TEMPORARY ENGINEERING WORKS - continued

At or between	Lines affected	Remarks
<u>LIVERPOOL STREET TO NORWICH - continued</u>		
SATURDAY/SUNDAY 20/21 SEPTEMBER		
86	Ilford Car Sheds (London End Jn) and Chadwell Heath Jn	Down and Up Main BLOCKED
		23 00 to 19 00. Drainage track maintenance, painting Chadwell Heath Station and bridgework (No. 92). Crane and mechanical equipment in use. <u>Isolation of electrical sections 323B, 324D. Trains to travel over Electric lines.</u>
87	Diss and Stowmarket Station	Up BLOCKED
		23 45 to 07 00. Loading materials.
88	Haughley Jn and Diss	Down BLOCKED
		23 30 to 07 15. Trimming lineside vegetation. Mechanical equipment in use.
89	Diss and Tivetshall Jn	Down and Up BLOCKED
		23 50 to 07 15. Track maintenance, track renewal and bridgework (No. 315). Crane and mechanical equipment in use.
90	Swainsthorpe and Trowse Upper Jn	Up BLOCKED Down BLOCKED
		23 00 to 07 00)Track maintenance and)loading rails. 23 55 to 07 00)Mechanical equipment in)use.
91	Trowse Upper Jn and Trowse Swing Bridge	Up BLOCKED Down BLOCKED
		23 00 to 07 00)Construction work) (overhead line). 23 59 to 07 00) <u>Possession to be given)</u> <u>up for passage of 1P04)</u> <u>02 10 Liverpool Street)</u> <u>to Norwich Yard over)</u> <u>Down line.</u>
92	Trowse Swing Bridge and Norwich	Crown Point Depot Nos. 1 and 2 Reception lines BLOCKED 'A'/'E' line BLOCKED Down Main/'W' line BLOCKED 'C' line/ Up Main BLOCKED
		22 00 to 07 00)Track maintenance,))track renewal,))signalling work and))construction work.))Crane and mechanical))equipment in use.)) <u>Possession to be given)</u> <u>up for passage of 1P04)</u> <u>02 10 Liverpool Street)</u> <u>to Norwich Yard over)</u> 23 00 to 07 00) <u>Down Main/'W' line.</u> 23 15 to 07 00) <u>(See Section 'C').</u>)

SECTION B - TEMPORARY ENGINEERING WORKS - continued

At or between	Lines affected	Remarks
<u>LIVERPOOL STREET TO NORWICH - continued</u>		
SATURDAY/SUNDAY 20/21 AND SUNDAY 21 SEPTEMBER		
93	Liverpool Street and Bethnal Green	Down and Up Suburban BLOCKED to electric trains
		23 15 Sat to 18 00)
		Repairs to station roof and overhead work. Crane and mechanical equipment in use.
	Liverpool Street Station	Platforms 9 and 10 BLOCKED to electric trains
		23 15 Sat to 04 15)
		Isolation of electrical sections 305 and 306. Electric trains to travel over Main or Electric lines. Trains to be replatformed as necessary.
		Platforms 1 to 8 inc. BLOCKED
		23 15 Sat to 18 00)
		Locomotive Holding Sidings BLOCKED to electric trains
		23 15 Sat to 18 00)
		Platforms 9 and 10 BLOCKED
		04 15 to 18 00 Sun)
)
)
)
)
94	Bethnal Green and Bow Jn	Down Electric and Up Main BLOCKED
		23 00 Sat to 11 00)
		Demolition work, signalling work, overhead line work, unloading materials and formation
		Down Main
		23 00 Sat to 11 00)
		Up Electric
		23 00 Sat to 18 00)
		renewal. Mechanical equipment in use.
		11 00 to 18 00 Sun)
		Isolation of electrical sections 310B, 311B. Down trains to travel over Down Main line. Up trains to travel over Up Electric line.
		23 00 Sat to 11 00)
	Bethnal Green and Stratford (London End)	Down Electric BLOCKED to electric trains
		23 00 Sat to 11 00)
		Isolation of electrical sections 310B, 311B. Down trains to travel over Down Main line. Up trains to travel over Up Electric line.

SECTION B - TEMPORARY ENGINEERING WORKS - continued

<u>At or between</u>	<u>Lines affected</u>	<u>Remarks</u>
----------------------	-----------------------	----------------

LIVERPOOL STREET TO NORWICH - continuedSATURDAY/SUNDAY 20/21 AND SUNDAY 21 SEPTEMBER - continued

95	New Hall G.F. and Kelvedon	Up Main BLOCKED Down Main BLOCKED	23 15 Sat to 06 45 00 55 to 07 15 Sun)Track maintenance,)track renewal and)drainage.)Mechanical)equipment in use.) <u>Possession to be given up for passage of 1Y02 02 20 Liverpool Street to Stowmarket and 1F46 03 15 Liverpool Street to Witham over Down Main line.</u>
96	Hill House G.F. and Stanway G.F.	Up Main BLOCKED Down Main BLOCKED	23 00 Sat to 07 30 01 00 to 16 00 Sun)Track maintenance,)formation renewal)and overhead line)work. Crane and)mechanical)equipment in use.) <u>23 00 Sat to 07 30 Possession to be given up for passage of 1Y02 02 20 Liverpool Street to Stowmarket over Up Main line under single line working. 07 15 to 16 00 Sun. Isolation of electrical sections 340ABC. 07 30 to 16 00 Sun. Single line working over Up Main line.</u>

SECTION B - TEMPORARY ENGINEERING WORKS - continued

At or between	Lines affected	Remarks
<u>LIVERPOOL STREET TO NORWICH - continued</u>		
SATURDAY/SUNDAY 20/21 AND SUNDAY 21 SEPTEMBER - continued		
97 Barham and Stowmarket Station	Down and Up Main BLOCKED Down and Up Main	23 30 Sat to 07 30 Track maintenance, track renewal and bridgework (No.262). Mechanical equipment in use. Possession to be given up for passage of 1Y02 02 20 Liverpool Street to Stowmarket over Down Main line.
SUNDAY 21 SEPTEMBER		
98 Liverpool Street and Hackney Downs	Down and Up Suburban BLOCKED	00 01 to 08 00. Track renewal (No.63A Points). 1m. 30chs. <u>Trains to travel over Main or Electric lines. Trains to/from Cambridge direction to travel over Fast lines between Bethnal Green and Hackney Downs.</u>
99 Church Lane LC and New Hall G.F.	Down and Up BLOCKED	00 50 to 07 00. Track renewal and track maintenance. Mechanical equipment in use. <u>Possession to be given up for passage of 1Y02 02 20 Liverpool Street to Stowmarket and 1F46 03 15 Liverpool Street to Witham over Down line.</u>
100 Chelmsford (Country End) and Stanway G.F.	All BLOCKED to electric trains	01 00 to 07 15. In connection with engineering work. <u>Isolation of electrical sections 335ABCDE, 336DEFG, 337, 338, 339FGH, 340ABC.</u>
101 Colchester and Ardleigh LC	Down Main BLOCKED	01 15 to 07 30. Track maintenance. Mechanical equipment in use. <u>Possession to be given up for passage of 1Y02 02 20 Liverpool Street to Stowmarket.</u>
102 Diss and Swainsthorpe	Down and Up	07 00 to 20 00. Signalling work.

SECTION B - TEMPORARY ENGINEERING WORKS - continued

<u>At or between</u>	<u>Lines affected</u>	<u>Remarks</u>
<u>LIVERPOOL STREET TO NORWICH - continued</u>		
SUNDAY 21 SEPTEMBER - continued		
103 Swainsthorpe	Down and Up	07 00 to 20 00. Signalling work.
104 Swainsthorpe and Trowse Lower Jn	Down and Up BLOCKED	07 00 to 20 00. Signalling work and bridgework (No.346). <u>Possession to be given up for passage of trains. (See Section 'C').</u>
SUNDAY 21 TO FRIDAY 26 SEPTEMBER		
105 Swainsthorpe and Norwich Station	All BLOCKED	23 45 Sun to Thu to 05 00 Mon to Fri. Construction work (overhead line) and track maintenance. <u>Possession to be given up for passage of trains.</u>
MONDAY 22 SEPTEMBER		
106 Bow Jn and Carpenters Road South Jn	Down and Up Cambridge BLOCKED	01 00 to 05 00. Overhead line work. <u>Isolation of electrical sections 312D, 431A, 432A. Possession to be given up for passage of Diesel trains between Bow Jn and Thornton Field Car. M.D.</u>
107 East Suffolk Jn and Haughley Jn	All BLOCKED to electric trains	01 30 to 04 30. In connection with overhead line work between Claydon LC and Stowmarket. <u>Isolation of electrical sections 345, 346, 347 and 348.</u>
108 Claydon LC and Stowmarket	Down and Up Main BLOCKED	01 30 to 04 30. Overhead line work. <u>Possession to be given up for passage of Diesel trains.</u>
109 Diss and Haughley Jn	Up BLOCKED	00 20 to 05 30. Unloading materials.
110 Diss and Swainsthorpe	Down and Up	07 00 to 18 00. Signalling work (Gissing and Newton Flotman LCs). Crane in use. <u>(See Section 'C').</u>

SECTION B - TEMPORARY ENGINEERING WORKS - continued

At or between	Lines affected	Remarks
<u>LIVERPOOL STREET TO NORWICH - continued</u>		
MONDAY 22 TO THURSDAY 25 SEPTEMBER		
111 Chadwell Heath Jn and Gidea Park Station Jn	Down and Up Electric BLOCKED	10 15 to 15 15 daily. Track maintenance. Mechanical equipment in use. <u>Trains to travel over Main lines.</u>
112 Romford Jn and Shenfield (London End Jn)	Down and Up Main BLOCKED	22 10 Mon to Wed to 05 00 Tue to Thu. Track maintenance and undertrack excavation. Mechanical equipment in use. <u>Trains to travel over Electric lines. 23 15 Mon to Wed to 05 00 Tue to Thu Isolation of electrical sections 327AB, 328BCD.</u>
113 Witham and New Hall G.F.	Up	09 00 to 16 00 daily. Track maintenance. 34m. 27chs. and 34m. 22chs.
TUESDAY 23 SEPTEMBER		
114 Liverpool Street Station	Platform 10 BLOCKED	10 00 to 15 30. Repairs to station roof. Mechanical equipment in use. <u>Isolation of electrical sections 305H. Trains to be replatformed as necessary.</u>
115 Marks Tey Station and Stanway G.F.	Down Main BLOCKED	00 10 to 04 40. Track maintenance and overhead line work. Mechanical equipment in use. <u>Isolation of electrical sections 340C. Single line working over Up Main line.</u>
TUESDAY 23 TO FRIDAY 26 SEPTEMBER		
116 Bethnal Green and Bow Jn	Down and Up Main BLOCKED	00 10 to 05 00 daily. Overhead line work. Mechanical equipment in use. <u>Isolation of electrical sections 311B, 312B. Trains to travel over Electric lines.</u>

SECTION B - TEMPORARY ENGINEERING WORKS - continued

At or between	Lines affected	Remarks
<u>LIVERPOOL STREET TO NORWICH - continued</u>		
WEDNESDAY 24 SEPTEMBER		
117 Stanway G.F. and Colchester	Down Main BLOCKED	00 15 to 04 40. Track maintenance and overhead line work. Mechanical equipment in use. <u>Isolation of electrical sections 340D. Single line working over Up Main line.</u>
THURSDAY 25 SEPTEMBER		
118 Liverpool Street Station	Platform 10 BLOCKED	10 00 to 15 30. Repairs to station roof. Mechanical equipment in use. <u>Isolation of electrical sections 305H. Trains to be replatformed as necessary.</u>
THURSDAY/FRIDAY 25/26 SEPTEMBER		
119 Romford Jn and Shenfield (London End Jn)	Down and Up Main BLOCKED	21 15 to 05 00. Track maintenance. Mechanical equipment in use. <u>Trains to travel over Electric lines. Access available to/from Upminster Branch.</u>
120 Stowmarket Station (Country End) and Haughley Jn	Down BLOCKED	23 30 to 05 45. Track maintenance. Mechanical equipment in use. <u>Single line working over Up line.</u>
121 Diss Station	Down and Up BLOCKED	23 40 to 05 15. Track maintenance. Mechanical equipment in use. <u>Possession to be given up for passage of trains.</u>
THURSDAY 25 AND FRIDAY 26 SEPTEMBER		
122 Colchester and Stanway G.F.	Up Main BLOCKED Platform 6 and Dock Road BLOCKED to electric trains	00 15 to 04 40 daily. Track maintenance and overhead line work. Mechanical equipment in use. <u>Isolation of electrical sections 339CDJL. Single line working over Down Main line.</u>

SECTION B - TEMPORARY ENGINEERING WORKS - continued

At or between	Lines affected	Remarks
<u>NAVARINO ROAD JN TO NORTH WOOLWICH</u>		
UNTIL FURTHER NOTICE		
123 Highbury and Homerton	All	07 30 to 18 00. Earthwork and construction work. Mechanical equipment in use. (86/1)
SUNDAY 21 SEPTEMBER		
124 Dalston Western Jn and Hackney Central	All BLOCKED to AC electric trains	08 00 to 22 00. In connection with engineering work between Bethnal Green and Hackney Downs. <u>Isolation of electrical sections 314DEF.</u>
125 Navarino Road Jn and Channelsea North Jn	Down and Up BLOCKED	00 01 to 08 00. Construction work (overhead line). Crane and mechanical equipment in use. <u>Isolation of electrical sections 707 and 708. Possession to be given up for passage of 1P04 02 10 Liverpool Street to Norwich Yard (diverted) and 1H02 03 10 Liverpool Street to King's Lynn (diverted) over Up line.</u>
126 Channelsea North Jn and Stratford Central Jn West	Down and Up	00 01 to 08 00. Construction work (overhead line). <u>Isolation of electrical sections 705C, 706A.</u>
127 Stratford Low Level and North Woolwich	All BLOCKED	00 15 to 08 00. Track maintenance. 4m. 09chs. and 8 ³ / ₄ m.p. <u>Isolation of electrical sections 701, 702, 703, 704, 705A, 706C.</u>
MONDAY 22 TO SATURDAY 27 SEPTEMBER		
128 Dalston Western Jn and Hackney Central	All BLOCKED to AC electric trains	23 59 Mon to Fri to 05 00 Tue to Sat. In connection with engineering work between Bethnal Green and Hackney Downs. <u>Isolation of electrical sections 314DEF.</u>

SECTION B - TEMPORARY ENGINEERING WORKS - continued

<u>At or between</u>	<u>Lines affected</u>	<u>Remarks</u>
<u>STRATFORD, LEA JN TO HIGH MEADS JN</u>		
SUNDAY 21 SEPTEMBER		
129 Lea Jn and High Meads Jn	Down and Up BLOCKED	00 01 to 08 00. Construction work (overhead line). Crane and mechanical equipment in use.

CHANNELSEA SOUTH JN TO STRATFORD CENTRAL JN WEST

UNTIL FURTHER NOTICE

130 Channelsea South Jn and Stratford Central Jn West	Down and Up BLOCKED to electric trains	In connection with engineering work. (86/14)
---	--	---

SUNDAY 21 SEPTEMBER

131 Channelsea North Jn and Stratford Central Jn West	Down and Up	00 01 to 08 00. Construction work (overhead line). <u>Isolation of electrical sections 705C, 706A.</u>
---	-------------	--

FOREST GATE JN TO WOODGRANGE PARK JN

SUNDAY 21 SEPTEMBER

132 Forest Gate Jn and Barking Station (Country End)	All BLOCKED to electric trains	00 50 to 06 15. In connection with engineering work between Woodgrange Park Jn and Barking Tilbury Line Jn West. <u>Isolation of electrical sections 512 and 513.</u>
--	--------------------------------------	---

SHENFIELD JN TO SOUTHEND VICTORIA

UNTIL FURTHER NOTICE

133 Billericay	Down and Up	07 30 to 17 30. Construction work and platform work. Mechanical equipment in use. (86/19)
134 Wickford Station	All	Platform work and earthwork. (85/63)

SECTION B - TEMPORARY ENGINEERING WORKS - continued

At or between	Lines affected	Remarks
---------------	----------------	---------

SHENFIELD JN TO SOUTHEND VICTORIA - continued

UNTIL FURTHER NOTICE - continued

135	Wickford Jn	All	08 00 to 17 00. Signalling work. (85/41)
136	Rayleigh and Hockley	Down	08 00 to 17 00. Earthwork 34½ and 34¾ m.p. Mechanical equipment in use. (85/61)
137	Southend Victoria Station	All	08 00 to 18 00. Repairs to station roof. (86/20)

SATURDAY 20 SEPTEMBER

138	Billericay and Hockley	All BLOCKED to electric trains	00 30 to 04 10. In connection with overhead line work between Wickford Jn and Southminster. <u>Isolation of electrical sections 373 and 374.</u>
-----	---------------------------	--------------------------------------	--

SATURDAY/SUNDAY 20/21 SEPTEMBER

139	Southend Victoria and Rochford	Up BLOCKED	23 45 to 05 45. Earthwork (Rochford Station). <u>Single line working over Down line.</u>
-----	--------------------------------------	---------------	---

SUNDAY 21 SEPTEMBER

140	Shenfield Jn and Billericay	All BLOCKED	00 35 to 06 15. Undertrack excavation. <u>Possession to be given up for passage of 1K06 03 20 Liverpool Street to Southend Victoria.</u>
-----	--------------------------------	----------------	---

WICKFORD JN TO SOUTHMINSTER

UNTIL FURTHER NOTICE

141	Wickford Jn	All	08 00 to 17 00. Signalling work. (85/41)
142	Fambridge Station	Single	07 30 to 18 00. Platform work. (85/55)
143	Burnham-on- Crouch	Single	07 30 to 18 00. Earthwork. 43m 24chs. (85/30)

SECTION B - TEMPORARY ENGINEERING WORKS - continued

At or between	Lines affected	Remarks
---------------	----------------	---------

WICKFORD JN TO SOUTHMINSTER - continued

SATURDAY 20 SEPTEMBER

144	Wickford Jn and Southminster	Single BLOCKED	00 30 to 04 10. Overhead line work. Mechanical equipment in use. <u>Isolation of electrical sections 377.</u>
-----	------------------------------------	-------------------	---

MONDAY 22 TO SATURDAY 27 SEPTEMBER

145	Wickford Jn and Southminster	Single BLOCKED	23 59 Mon to Fri to 04 45 Tue to Sat. Overhead line work. Mechanical equipment in use. <u>Isolation of electrical sections 377.</u>
-----	------------------------------------	-------------------	---

WITHAM TO BRAINTREE

UNTIL FURTHER NOTICE

146	Witham and Braintree	Single	07 00 to 18 00. Construction work (Bridge No. 2102B). (86/19)
-----	-------------------------	--------	---

SUNDAY 21 SEPTEMBER

147	Witham and Braintree	Single BLOCKED to electric trains	01 00 to 07 15. In connection with engineering work. <u>Isolation of electrical sections 379.</u>
-----	-------------------------	---	--

COLCHESTER TO CLACTON

UNTIL FURTHER NOTICE

148	Colchester Jn and East Gate Jn	Down Clacton Avoiding	08 00 to 17 00. Earthwork. 52m. 25chs. and 52m. 29chs. Mechanical equipment in use. (85/38)
-----	--------------------------------------	--------------------------	--

SATURDAY/SUNDAY 20/21 SEPTEMBER

149	Colchester Jn and Hythe Station	Down and Up BLOCKED	23 30 to 07 15. Level crossing road repairs 53½ m.p. and 53m. 21chs. <u>Possession to be given up for passage of Engineers' trains.</u>
-----	---------------------------------------	------------------------	---

SECTION B - TEMPORARY ENGINEERING WORKS - continued

At or between	Lines affected	Remarks
---------------	----------------	---------

COLCHESTER TO CLACTON - continued

SATURDAY/SUNDAY 20/21 SEPTEMBER - continued

150	Hythe Station and Great Bentley	Down BLOCKED Up BLOCKED	23 30 to 08 00)Track maintenance,)track renewal, 23 30 to 16 00)formation renewal and)overhead line work.)Mechanical equipment)in use. 07 15 to 16 00) <u>Sun. Isolation of</u>) <u>electrical sections</u>) <u>383D. 08 00 to</u>) <u>16 00 Sun. Single</u>) <u>line working over</u>) <u>Down line.</u>
-----	---------------------------------------	----------------------------------	--

SUNDAY 21 SEPTEMBER

151	Alresford and Clacton	All BLOCKED to electric trains	00 10 to 07 15. In connection with engineering work between Hythe Station and Great Bentley. <u>Isolation</u> <u>of electrical sections 383, 384, 385</u> <u>and 386.</u>
-----	--------------------------	--------------------------------------	---

THURSDAY/FRIDAY 25/26 SEPTEMBER

152	East Gate Jn and Thorpe-le-Soken	Down and Up BLOCKED	23 30 to 04 45. Track maintenance. Mechanical equipment in use. <u>Possession to be given up for passage</u> <u>of Freight trains to/from Hythe.</u>
-----	--	------------------------	---

THORPE-LE-SOKEN TO WALTON-ON-NAZE

SUNDAY 21 SEPTEMBER

153	Thorpe-le-Soken and Walton-on-Naze	Single BLOCKED to electric trains	00 10 to 07 15. In connection with engineering work between Hythe Station and Great Bentley. <u>Isolation</u> <u>of electrical sections 387.</u>
-----	--	---	---

SECTION B - TEMPORARY ENGINEERING WORKS - continued

At or between	Lines affected	Remarks
---------------	----------------	---------

MANNINGTREE SOUTH JN TO HARWICH

UNTIL FURTHER NOTICE

154	Wrabness and Mistley	Up	07 30 to 17 00. Earthwork. 64m. 46chs. and 64m. 15chs. Mechanical equipment in use. (85/65)
155	Parkeston West and Harwich Town	Single	07 30 to 18 00. Track maintenance, track renewal and earthwork. 70½m.p. Mechanical equipment in use. (85/27)

FRIDAY/SATURDAY 19/20 SEPTEMBER

156	Manningtree South Jn and Harwich Town	All BLOCKED to electric trains	23 45 to 04 30. In connection with overhead line work between Wrabness and Dovercourt. <u>Isolation of electrical sections 391 and 392.</u>
157	Wrabness and Dovercourt	All BLOCKED	23 45 to 04 30. Overhead line work. Mechanical equipment in use. <u>Possession to be given up for passage of Diesel trains.</u>

EAST SUFFOLK JN TO OULTON BROAD NORTH JN

UNTIL FURTHER NOTICE

158	Melton and Wickham Market	Single	07 00 to 18 00. Bridgework (No. 426). 81m. 11chs. Crane in use. (85/26)
-----	---------------------------	--------	---

SATURDAY/SUNDAY 20/21 AND SUNDAY 21 SEPTEMBER

159	Saxmundham and Halesworth	Down and Up BLOCKED Down and Up <u>Between Trains</u>	21 50 Sat to 16 00 Sun))Level crossing)road repairs)Middleton and)Wenhaston LCs.))and track)maintenance.)Crane in use.
-----	---------------------------	--	--

SECTION B - TEMPORARY ENGINEERING WORKS - continued

<u>At or between</u>	<u>Lines affected</u>	<u>Remarks</u>
----------------------	-----------------------	----------------

EAST SUFFOLK JN TO OULTON BROAD NORTH JN - continued

MONDAY/TUESDAY 22/23 SEPTEMBER

160	Westerfield and Up East Suffolk Jn	BLOCKED	23 15 to 05 30. Track maintenance. Mechanical equipment in use. <u>Single line working over Down line.</u>
-----	---------------------------------------	---------	--

MONDAY 22 TO FRIDAY 26 SEPTEMBER

161	Woodbridge and Saxmundham	All BLOCKED	23 15 Mon to Thu to 06 15 Tue to Fri. Loading rails. Crane and mechanical equipment in use.
162	Halesworth and Oulton Broad North Jn	Single	08 00 to 16 00 daily. Track maintenance 100% and 115% m.p. Mechanical equipment in use.

WEDNESDAY 24 SEPTEMBER

163	Woodbridge and Saxmundham	Single	10 00 to 12 00. Signalling work (Ufford LC). <u>(See Section 'C').</u>
-----	------------------------------	--------	--

WESTERFIELD JN TO FELIXSTOWE

UNTIL FURTHER NOTICE

164	Westerfield Jn and Derby Road	Single	08 00 to 16 00. Earthwork. 73m. 13chs. and 73 $\frac{1}{2}$ m.p. (85/61)
165	Derby Road and Felixstowe Beach Jn	Single	07 30 to 17 00. Earthwork. 82% and 83m.p. Mechanical equipment in use. (86/1)

NORWICH TO LOWESTOFT

UNTIL FURTHER NOTICE

166	Norwich Station	All	Track renewal, platform work and earthwork. Crane and mechanical equipment in use. (85/62)
-----	--------------------	-----	---

SECTION B - TEMPORARY ENGINEERING WORKS - continued

At or between	Lines affected	Remarks
---------------	----------------	---------

NORWICH TO LOWESTOFT - continued

UNTIL FURTHER NOTICE - continued

167	Norwich Station and Trowse Lower Jn	All <u>Between Trains</u>	07 00 to 17 00. Construction work (overhead line), earthwork, track maintenance and signalling work. Points and signals disconnected. (86/7)
168	Thorpe Jn	All	08 00 to 17 00. Earthwork and track maintenance. (85/22)
169	Whitlingham Jn and Thorpe Jn	Up	07 30 to 17 00. Earthwork 1½ and 1m.p. Mechanical equipment in use. (86/13)
170	Reedham Swing Bridge	Down and Up BLOCKED	08 00 to 16 00. Bridgework (No. 1238). <u>Possession to be given up for passage of trains.</u> (86/23)
171	Oulton Broad North Jn and Lowestoft	All	08 00 to 16 00. Undertrack excavation. 23 and 23½ m.p. <u>From 08 00 Monday 22 September.</u> (86/26)

SATURDAY 20 SEPTEMBER

172	Thorpe Jn	'A'/'E' line	21 00 to 22 00. Signalling work.
-----	-----------	--------------	----------------------------------

SATURDAY/SUNDAY 20/21 SEPTEMBER

173	Trowse Swing Bridge and Norwich	Crown Point Depot Nos. 1 and 2 Reception lines	22 00 to 07 00)Track maintenance,)track renewal,)signalling work and)construction work.)Crane and mechanical)equipment in use.) <u>Possession to be given up for passage of 1P04 02 10</u>) <u>Liverpool Street to Norwich Yard over Down Main/'W' line.</u>) <u>(See Section 'C').</u>
		BLOCKED		
		'A'/'E' line	22 00 to 16 00	
		BLOCKED		
		Down Main/'W' line	23 00 to 07 00	
		BLOCKED		
		'C' line/Up Main	23 15 to 07 00	
		BLOCKED		

SECTION B - TEMPORARY ENGINEERING WORKS - continued

At or between	Lines affected	Remarks
---------------	----------------	---------

NORWICH TO LOWESTOFT - continued

SATURDAY/SUNDAY 20/21 SEPTEMBER - continued

174	Cantley and Reedham Jn	Up	22 45 to 07 00)	Loading rails. Crane)and mechanical equipment in use.) <u>Possession to be given up for passage of 1B02 05 54 Trowse to Lowestoft and 1G02 06 04 Trowse to Yarmouth over Down line, and 5B02 04 25 Lowestoft to Trowse over Up line.</u>
		BLOCKED		
		Down	23 35 to 07 00)	
		BLOCKED		

SUNDAY 21 TO FRIDAY 26 SEPTEMBER

175	Swainsthorpe and Norwich Station	All BLOCKED	23 45 Sun to Thu to 05 00 Mon to Fri.	Construction work (overhead line) and track maintenance. <u>Possession to be given up for passage of trains.</u>
-----	--	----------------	---------------------------------------	---

MONDAY/TUESDAY 22/23 SEPTEMBER

176	Whitlingham Jn and Brundall Jn	Down and Up BLOCKED	23 30 to 05 15.	Trimming lineside vegetation. Mechanical equipment in use.
-----	--------------------------------------	------------------------	-----------------	--

THURSDAY/FRIDAY 25/26 SEPTEMBER

177	Whitlingham Jn and Brundall Jn	Down and Up BLOCKED	23 30 to 05 15.	Trimming lineside vegetation. Mechanical equipment in use.
-----	--------------------------------------	------------------------	-----------------	--

WHITLINGHAM JN TO CROMER

UNTIL FURTHER NOTICE

178	Whitlingham Jn and Wroxham	Down and Up	07 30 to 16 30.	Bridgework (No. 365). 3m. 48chs. (86/6)
179	Cromer Station	Platforms 1 and 2		Platform work. (86/15)

SECTION B - TEMPORARY ENGINEERING WORKS - continued

At or between	Lines affected	Remarks
<u>CROMER TO SHERINGHAM</u>		
UNTIL FURTHER NOTICE		
180 Cromer Station	Platforms 1 and 2	Platform work. (86/15)
<u>BRUNDALL JN TO YARMOUTH VIA ACLE</u>		
UNTIL FURTHER NOTICE		
181 Lingwood	Single	08 00 to 17 00. Construction work. 8m. 03chs. (86/12)
182 Acle Station	Down and Up	08 00 to 17 00. Platform work. (86/20)
<u>BETHNAL GREEN JN TO KING'S LYNN</u>		
UNTIL FURTHER NOTICE		
183 Cambridge Heath Station	Down and Up Suburban	08 00 to 17 00. Platform work. Mechanical equipment in use. <u>(See Section 'D')</u> . (86/24)
184 Enfield Lock and Waltham Cross	Down and Up	07 00 to 18 00. Bridgework (No.1418C). 12m. 34chs. Crane and mechanical equipment in use. (85/59)
185 Bishops Stortford (Country end) and Stansted	Down and Up Main BLOCKED to electric trains	Overhead line work. <u>Isolation of electrical sections 427, 428 (buffer section)</u> . (85/41)
186 Bishops Stortford and Cambridge (North)	All	07 00 to 18 00. Construction work (overhead line). Mechanical equipment in use. (85/21)
187 Stansted	Down and Up	Construction work. 33m. 29chs. (85/61)
188 Elsenham	Down and Up	Construction work. 35m. 44chs. (85/61)

SECTION B - TEMPORARY ENGINEERING WORKS - continued

At or between	Lines affected	Remarks
<u>BETHNAL GREEN JN TO KING'S LYNN - continued</u>		
UNTIL FURTHER NOTICE - continued		
189 Newport	Down and Up	08 00 to 16 00. Platform work 39m. 74chs. Mechanical equipment in use. (85/37)
190 Whittlesford Station	Down	Platform work 49m 02chs. Mechanical equipment in use. (86/21)
191 Shelford	Down and Up	Platform work. 52m. 36chs. Mechanical equipment in use. (86/6)
192 Chesterton Jn and Milton Fen LC	Down and Up	07 30 to 18 00. Bridgework (No. 1550B). 58m. 63chs. Mechanical equipment in use. (86/24)

SATURDAY 20 SEPTEMBER

193 Bethnal Green (Country End) and Bury Street Jn	Down and Up Suburban/ Down and Up BLOCKED to electric trains	00 20 to 04 35. In connection with overhead line work between Hackney Downs North Jn and Seven Sisters. <u>Isolation of electrical sections 401 and 402. Electric trains to travel over Fast lines and to be diverted via Clapton.</u>
---	--	---

SATURDAY/SUNDAY 20/21 SEPTEMBER

194 Bishops Stortford and Elsenham	Up Main BLOCKED Down Main BLOCKED	22 45 to 08 15)Construction work) (overhead line). 23 50 to 10 00)30% and 35% m.p.) Mechanical equipment) in use. 1P02 02 10) Liverpool Street to) Norwich Yard and 1H02) 03 10 Liverpool Street) to King's Lynn diverted) via Finsbury Park and) Hitchin.
--	--	---

SECTION B - TEMPORARY ENGINEERING WORKS - continued

At or between	Lines affected	Remarks
<u>BETHNAL GREEN JN TO KING'S LYNN - continued</u>		
SATURDAY/SUNDAY 20/21 SEPTEMBER - continued		
195 Audley End and Whittlesford Crossovers	Up Main BLOCKED Down Main BLOCKED	22 20 to 08 15)Construction work)overhead line) and 23 55 to 10 00)trimming lineside)vegetation. 41% and)49% m.p. Mechanical)equipment in use.) <u>1P04 02 10 Liverpool</u>) <u>Street to Norwich Yard</u>)and <u>1H02 03 10</u>) <u>Liverpool Street to</u>) <u>King's Lynn diverted</u>) <u>via Finsbury Park and</u>) <u>Hitchin.</u>

SATURDAY/SUNDAY 20/21 AND SUNDAY 21 SEPTEMBER

196 Chesterton Jn and Waterbeach	Down BLOCKED Up BLOCKED	22 30 Sat to 07 50)Track maintenance.)58% and 59m.p. 00 01 to 08 30 Sun)Possession to be) <u>given up for</u>) <u>passage of 1P04</u>) <u>02 10 Liverpool</u>) <u>Street to Norwich</u>) <u>Yard and 1H02</u>) <u>Liverpool Street</u>) <u>to King's Lynn over</u>) <u>Down line.</u>
----------------------------------	----------------------------------	--

SATURDAY 20 AND SUNDAY 21 SEPTEMBER

197 Cheshunt Jn and Bishops Stortford	All	06 00 to 17 00 daily. Signalling work.
---------------------------------------	-----	--

SUNDAY 21 SEPTEMBER

198 Liverpool Street and Hackney Downs	Down and Up Suburban BLOCKED	00 01 to 08 00. Track renewal (No. 63A points). 1m. 30chs. <u>Trains to travel over Main or Electric lines.</u> <u>Trains to/from Cambridge direction to travel over Fast lines between</u> <u>Bethnal Green and Hackney Downs.</u>
--	------------------------------------	---

SECTION B - TEMPORARY ENGINEERING WORKS - continued

<u>At or between</u>	<u>Lines affected</u>	<u>Remarks</u>
<u>BETHNAL GREEN JN TO KING'S LYNN - continued</u>		
<u>SUNDAY 21 SEPTEMBER - continued</u>		
199 Bethnal Green (Country End) and Hackney Downs	Down and Up Suburban BLOCKED	08 00 to 22 00. Platform work (Cambridge Heath Station) and bridgework (No. 428). Mechanical equipment in use. <u>Isolation of electrical sections 313A, 314B. Trains to travel over Fast lines.</u>
200 Clapton Jn and Cheshunt Jn	Down and Up Main BLOCKED to electric trains	00 01 to 22 00. In connection with engineering work between Tottenham South Jn and Cheshunt Jn. <u>Isolation of electrical sections 411 and 412. Electric trains diverted via Southbury.</u>
201 Tottenham South Jn and Cheshunt Jn	Down and Up Main BLOCKED	00 01 to 22 00. Drainage, track maintenance, track renewal and platform work (Enfield Lock Station). Crane and mechanical equipment in use. <u>Trains to/from Cambridge diverted via Finsbury Park and Hitchin. Other trains diverted via Southbury.</u>
202 Broxbourne Jn and Bishops Stortford	All BLOCKED	00 30 to 15 45. Track maintenance, track renewal, bridgework (No. 1436) and overhead line work. Crane and mechanical equipment in use. <u>Trains diverted via Finsbury Park and Hitchin. 00 35 to 15 30 Isolation of electrical sections 413A, 414J, 415, 416, 417 and 418.</u>
203 Audley End	Down and Up <u>Between Trains</u>	07 30 to 16 00. Bridgework (No. 1517). 41m. 54chs.
204 Shepreth Branch Jn and Cambridge	All BLOCKED	00 10 to 08 00. Construction work (overhead line). 53% and 55% <u>m.p.</u> Mechanical equipment in use. <u>Possession to be given up for passage of trains.</u>
205 Cambridge Station	All BLOCKED	00 10 to 08 00. Track maintenance and construction work (overhead line). 55% and 55% <u>m.p.</u> Mechanical equipment in use. <u>Possession to be given up for passage of trains.</u>

SECTION B - TEMPORARY ENGINEERING WORKS - continued

At or between	Lines affected	Remarks
BETHNAL GREEN JN TO KING'S LYNN - continued		
SUNDAY 21 SEPTEMBER - continued		
206 Cambridge and Coldham Lane Jn	All BLOCKED	00 10 to 08 00. Construction work (overhead line). 55% and 56% m.p. Mechanical equipment in use. <u>Possession to be given up for passage of trains.</u>
207 Ely Dock Jn and Waterbeach	Up BLOCKED	00 01 to 08 00. Loading materials. 69 and 61 m.p.
MONDAY 22 SEPTEMBER		
208 Cheshunt Jn (London End) and Broxbourne Jn (Country End)	All BLOCKED to electric trains	00 40 to 03 50. In connection with overhead line work. <u>Isolation of electrical sections 413 and 414.</u>
209 Cheshunt Station	All BLOCKED	00 40 to 03 50. Overhead line work. <u>Possession to be given up for passage of Diesel trains.</u>
MONDAY 22 TO THURSDAY 25 SEPTEMBER		
210 Spelbrook and Harlow Mill	Up BLOCKED	22 55 Mon to Wed to 04 45 Tue to Thu. Track maintenance and unloading materials. Mechanical equipment in use. <u>Single line working over Down line.</u>
MONDAY 22 TO FRIDAY 26 SEPTEMBER		
211 Shepreth Branch Jn and Coldham Lane Jn	All <u>Between Trains</u>	08 00 to 16 00 daily. Construction work (overhead line). 53% and 56% m.p. Mechanical equipment in use.

SECTION B - TEMPORARY ENGINEERING WORKS - continued

<u>At or between</u>	<u>Lines affected</u>	<u>Remarks</u>
----------------------	-----------------------	----------------

BETHNAL GREEN JN TO KING'S LYNN - continued

MONDAY 22 TO SATURDAY 27 SEPTEMBER

212 Bethnal Green (Country End) and Hackney Downs	Down and Up Suburban BLOCKED	21 00 Mon to Fri to 05 00 Tue to Sat. Platform work (London Fields Station) and overhead line work. Mechanical equipment in use. <u>Trains to travel over Fast lines. 23 59 Mon to Fri to 05 00 Tue to Sat Isolation of electrical sections 313A, 314B.</u>
--	------------------------------------	--

TUESDAY 23 SEPTEMBER

213 Ely Dock Jn and Waterbeach	Up BLOCKED	00 35 to 05 20. Track maintenance. 69 and 61m.p. Mechanical equipment in use. <u>Single line working over Down line.</u>
--------------------------------------	---------------	--

TUESDAY/WEDNESDAY 23/24 SEPTEMBER

214 Bishops Stortford and Spelbrook	Up Main	23 00 to 04 30. Unloading materials.
---	---------	--------------------------------------

TUESDAY 23 TO FRIDAY 26 SEPTEMBER

215 Hackney Downs and Clapton Jn	Down and Up Fast/Main BLOCKED	00 45 to 04 45 daily. Track maintenance. Mechanical equipment in use. <u>Trains to travel over Suburban lines and to be diverted via Southbury.</u>
-------------------------------------	-------------------------------------	---

WEDNESDAY/THURSDAY 24/25 SEPTEMBER

216 Broxbourne and Harlow Mill	Down and Up Main	23 45 to 04 15. Unloading materials.
217 Audley End and Great Chesterford	Down BLOCKED	22 35 to 05 30. Track maintenance. 36 and 41 $\frac{1}{2}$ m.p. Mechanical equipment in use. <u>Single line working over Up line.</u>

SECTION B - TEMPORARY ENGINEERING WORKS - continued

<u>At or between</u>	<u>Lines affected</u>	<u>Remarks</u>
<u>READING LANE JN TO NAVARINO ROAD JN (GRAHAM ROAD CURVE)</u>		
SUNDAY 21 SEPTEMBER		
218 Reading Lane Jn and Navarino Road Jn	Single BLOCKED to electric trains	08 00 to 22 00. In connection with engineering work between Bethnal Green and Hackney Downs. <u>Isolation of electrical sections 314C.</u>

MONDAY 22 TO SATURDAY 27 SEPTEMBER

219 Reading Lane Jn and Navarino Road Jn	Single BLOCKED to electric trains	23 59 Mon to Fri to 05 00 Tue to Sat. In connection with engineering work between Bethnal Green and Hackney Downs. <u>Isolation of electrical sections 314C.</u>
--	-----------------------------------	--

HACKNEY DOWNS NORTH JN TO ENFIELD TOWN

SATURDAY 20 SEPTEMBER

220 Bethnal Green (Country End) and Bury Street Jn	Down and Up Suburban/ Down and Up BLOCKED to electric trains	00 20 to 04 35. In connection with overhead line work between Hackney Downs North Jn and Seven Sisters. <u>Isolation of electrical sections 401 and 402. Electric trains to travel over Fast lines and to be diverted via Clapton.</u>
221 Hackney Downs North Jn and Seven Sisters	Down and Up BLOCKED	00 20 to 04 35. Overhead line work. Mechanical equipment in use. <u>Trains diverted via Clapton.</u>

BURY STREET JN TO CHESHUNT

SATURDAY 20 AND SUNDAY 21 SEPTEMBER

222 Bury Street Jn and Cheshunt Jn	Down and Up	06 00 to 17 00 daily. Signalling work.
------------------------------------	-------------	--

MONDAY 22 SEPTEMBER

223 Bury Street Jn and Cheshunt Jn	Down and Up BLOCKED	00 40 to 03 50. Overhead line work. <u>Isolation of electrical sections 405 and 406.</u>
------------------------------------	---------------------	--

SECTION B - TEMPORARY ENGINEERING WORKS - continued

At or between	Lines affected	Remarks
---------------	----------------	---------

BURY STREET JN TO CHESHUNT - continued

MONDAY 22 TO THURSDAY 25 SEPTEMBER

224	Cheshunt Jn and Southbury	Up BLOCKED	10 15 to 15 15 daily. Loading materials. <u>Single line working over Down line.</u>
-----	---------------------------------	---------------	---

CLAPTON JN TO CHINGFORD

SUNDAY 21 SEPTEMBER

225	Chingford	All	08 00 to 17 00. Signalling work.
-----	-----------	-----	----------------------------------

BROXBOURNE JN TO HERTFORD EAST

UNTIL FURTHER NOTICE

226	Rye House and St. Margarets	Down and Up	08 00 to 18 00. Bridgework (No. 2035A). 19m. 66chs. Mechanical equipment in use. (85/60)
-----	--------------------------------	-------------	---

MONDAY 22 SEPTEMBER

227	Broxbourne Jn and St. Margarets	Down and Up BLOCKED to electric trains	00 40 to 03 50. In connection with overhead line work. <u>Isolation of electrical sections 414.</u>
-----	---------------------------------------	--	---

COLDHAM LANE JN TO HAUGHLEY JN

UNTIL FURTHER NOTICE

228	Bury St. Edmunds Station	Down	08 00 to 15 00. Repairs to platform awnings. (86/18)
229	Bury St. Edmunds and Elmswell	Down and Up	08 00 to 18 00. Drainage 29m. 78chs. Mechanical equipment in use. (86/12)

SECTION B - TEMPORARY ENGINEERING WORKS - continued

At or between	Lines affected	Remarks
---------------	----------------	---------

COLDHAM LANE JN TO HAUGHLEY JN - continued

SATURDAY/SUNDAY 20/21 SEPTEMBER

230	Bury St. Edmunds and Haughley Jn	Up BLOCKED Down BLOCKED	22 00 to 08 00) Drainage, demolition work, track 23 15 to 16 00) maintenance and reballasting. Mechanical equipment in use. 08 00 to 16 00 Sun Single line working over Up line.
-----	--	----------------------------------	---

CHIPPENHAM JN TO ELY DOCK JN

UNTIL FURTHER NOTICE

231	Soham and Chippenham Jn	Up <u>Between Trains</u>	07 00 to 19 00. Earthwork and track renewal 3m.p. Mechanical equipment in use. (86/22)
-----	----------------------------	-----------------------------	---

ELY NORTH JN TO PETERBOROUGH, CRESCENT JN

SATURDAY/SUNDAY 20/21 SEPTEMBER

232	Black Bank and Manea	Down and Up BLOCKED	23 30 to 08 30. Bridgework (No. 1814) 78m. 4lchs. Crane in use.
233	March West Jn and Crescent Jn	Down and Up Main BLOCKED	23 30 to 08 00. Bridgework (No. 184), repairing fencing and track maintenance. 89 and 100m.p. Mechanical equipment in use.

SUNDAY/MONDAY 21/22 SEPTEMBER

234	March West Jn and Whittlesea	Down Main BLOCKED	23 00 to 06 00. Track maintenance. 93% and 94m.p. Mechanical equipment in use. <u>Single line working over Up Main line.</u>
-----	------------------------------------	----------------------	--

SECTION B - TEMPORARY ENGINEERING WORKS - continued

At or between	Lines affected	Remarks
---------------	----------------	---------

ELY NORTH JN TO PETERBOROUGH, CRESCENT JN - continued

TUESDAY/WEDNESDAY 23/24 SEPTEMBER

235	Chettisham and Manea	Down BLOCKED	23 20 to 04 15. Track maintenance. 73 $\frac{3}{4}$ and 80m.p. Mechanical equipment in use. <u>Single line working over Up line.</u>
-----	----------------------	-----------------	--

WEDNESDAY/THURSDAY 24/25 SEPTEMBER

236	Manea and March South Jn	Down BLOCKED	23 20 to 04 15. Track maintenance. 80 $\frac{3}{4}$ and 81 $\frac{1}{4}$ m.p. Mechanical equipment in use. <u>Single line working over Up line.</u>
-----	--------------------------	-----------------	---

FRIDAY 26 SEPTEMBER

237	Manea and Chettisham	Up BLOCKED	00 01 to 05 00. Track maintenance. 80 and 73 $\frac{3}{4}$ m.p. Mechanical equipment in use. <u>Single line working over Down line.</u>
-----	----------------------	---------------	---

ELY NORTH JN TO TROWSE LOWER JN

UNTIL FURTHER NOTICE

238	Thetford and Lakenheath	Up	08 00 to 16 00. Track maintenance. 87 $\frac{3}{4}$ and 85 $\frac{1}{4}$ m.p. (86/24)
239	Wymondham and Hethersett	Down and Up <u>Between Trains</u>	07 30 to 18 00. Bridgework, earthwork and construction work. 115m. 65chs. and 117m. 69chs. Cranes and mechanical equipment in use. (86/18)
240	Wymondham and Trowse Lower Jn	Down and Up	07 30 to 16 00. Signalling work. (85/24)
241	Hethersett and Trowse Lower Jn	Down and Up	07 30 to 16 00. Bridgework (Nos.1638, 1640, 1640A and 349). 121m. 17chs. and 122m. 32chs. (86/22)

SECTION B - TEMPORARY ENGINEERING WORKS - continued

At or between	Lines affected	Remarks
---------------	----------------	---------

ELY NORTH JN TO TROWSE LOWER JN - continued

FRIDAY/SATURDAY 19/20 SEPTEMBER

242	Wymondham and Trowse Lower Jn	Down and Up BLOCKED	23 00 to 06 30. Signalling work. Mechanical equipment in use.
-----	-------------------------------	------------------------	--

SATURDAY/SUNDAY 20/21 SEPTEMBER

243	Harling Road and Eccles Road	Down and Up BLOCKED	23 00 to 08 00. Earthwork. Mechanical equipment in use. <u>Possession to be given up for passage of trains.</u>
-----	------------------------------	------------------------	---

WYMONDHAM TO NORTH ELMHAM

UNTIL FURTHER NOTICE

244	Wymondham and North Elmham	Single	08 00 to 16 00. Trimming lineside vegetation. $\frac{1}{2}$ and 6m.p. Mechanical equipment in use. (85/31)
-----	----------------------------	--------	---

FENCHURCH STREET TO SHOE BURYNESS

UNTIL FURTHER NOTICE

245	Fenchurch Street Station	All	Construction/demolition work. Mechanical equipment in use. (84/38)
246	Fenchurch Street and Stepney East	All	Construction work, and in connection with engineering work (Docklands Light Railway). Mechanical equipment in use. <u>(See Section 'D')</u> . (86/25)
247	Fenchurch Street and Gas Factory Jn	All	08 00 to 17 00. Signalling work. (86/1)
248	East Ham	Down and Up	Construction work. Mechanical equipment in use. (83/51)

SECTION B - TEMPORARY ENGINEERING WORKS - continued

At or between	Lines affected	Remarks
---------------	----------------	---------

FENCHURCH STREET TO SHOEBURYNESS - continued

UNTIL FURTHER NOTICE - continued

249	East Ham and Barking (London End)	Down and Up	Erecting scaffolding in connection with bridge No. 66B. (85/8)
250	Leigh-on-Sea and Benfleet	Up	Sea wall work. (85/34)
251	Leigh-on-Sea	Down	09 00 to 16 00. Demolition work. Mechanical equipment in use. (85/60)
252	Westcliff-on-Sea	Down	09 00 to 16 00. Demolition work. Mechanical equipment in use. (85/60)

FRIDAY/SATURDAY 19/20 SEPTEMBER

253	Fenchurch Street	All BLOCKED	21 15 to 06 00. Construction work. Mechanical equipment in use.
254	Fenchurch Street and Gas Factory Jn	All BLOCKED	21 15 to 06 00. Repairs to platform awnings (Stepney East Station), construction work and painting Stepney East Station. <u>Isolation of electrical sections 501, 502, 503 and 504.</u>

SATURDAY 20 TO MONDAY 22 SEPTEMBER

255	Fenchurch Street and Christian Street Jn.	Down and Up Slow BLOCKED	21 15 Sat to 04 00 Mon. Bridgework (Nos. 81 and 82). Om. 45chs. <u>Trains to travel over Fast lines.</u>
-----	---	--------------------------	--

SUNDAY 21 SEPTEMBER

256	East Ham (London End) and Barking Station (Country End)	Down and Up Main BLOCKED	00 30 to 17 30. Overhead line work (conversion). Mechanical equipment in use. <u>Isolation of electrical sections 510ABC, 511CDE. Trains diverted to/from Liverpool Street via Stratford and Forest Gate Jn and to travel over Tilbury lines.</u>
-----	---	--------------------------	---

SECTION B - TEMPORARY ENGINEERING WORKS - continued

At or between	Lines affected	Remarks
---------------	----------------	---------

FENCHURCH STREET TO SHOEBURYNESS - continued

SUNDAY 21 SEPTEMBER - continued

257 Forest Gate Jn and Barking Station (Country End)	All BLOCKED to electric trains	00 50 to 06 15. In connection with engineering work between Woodgrange Park Jn and Barking Tilbury Line Jn West. <u>Isolation of electrical sections 512 and 513.</u>
--	--------------------------------	---

MONDAY 22 TO WEDNESDAY 24 SEPTEMBER

258 Fenchurch Street and East Ham (London End)	All BLOCKED	21 15 Mon to Wed to 06 15 Tue to Thu. Repairs to platform awnings (Stepney East Station), construction work, painting Stepney East Station, track maintenance and track renewal.
--	-------------	--

MONDAY 22 TO SATURDAY 27 SEPTEMBER

259 Fenchurch Street	All BLOCKED	21 15 Mon to Fri to 06 00 Tue to Sat. Construction work. Mechanical equipment in use.
260 Fenchurch Street and Gas Factory Jn	All BLOCKED to electric trains	21 15 Mon to Fri to 06 00 Tue to Sat. In connection with engineering work. <u>Isolation of electrical sections 501, 502, 503 and 504.</u>

TUESDAY 23 AND WEDNESDAY 24 SEPTEMBER

261 Upminster and Pitsea	Down and Up BLOCKED	01 15 to 04 25 daily. Overhead line work. Crane and mechanical equipment in use. <u>Isolation of electrical sections 517, 518, 519 and 520.</u> <u>Trains diverted via Grays.</u>
--------------------------	---------------------	---

TUESDAY 23 TO FRIDAY 26 SEPTEMBER

262 Benfleet Station	Down and Up	00 50 to 04 20 daily. Painting Benfleet station.
----------------------	-------------	--

SECTION B - TEMPORARY ENGINEERING WORKS - continued

At or between	Lines affected	Remarks
---------------	----------------	---------

FENCHURCH STREET TO SHOEBURYNESSE - continued

THURSDAY 25 AND FRIDAY 26 SEPTEMBER

263	Pitsea and Southend Central	Down and Up BLOCKED	01 35 to 04 20 daily. Track maintenance. Mechanical equipment in use.
-----	-----------------------------	------------------------	---

THURSDAY 25 TO SATURDAY 27 SEPTEMBER

264	Fenchurch Street and Gas Factory Jn.	All BLOCKED	21 15 Thu and Fri to 06 00 Fri and Sat. Repairs to platform awnings (Stepney East Station), construction work and painting Stepney East Station.
-----	--------------------------------------	----------------	--

UPPER HOLLOWAY TO BARKING, TILBURY LINE JN WEST

UNTIL FURTHER NOTICE

265	Upper Holloway and Crouch Hill Station	Down and Up	Earthwork. 3m 41chs. and 3m 43chs. Mechanical equipment in use. (85/64)
266	Wanstead Park Station	Up	08 00 to 16 00. Platform work. <u>(See Section 'D')</u> . (85/50)
267	Woodgrange Park and Barking Station Jn	Down and Up <u>Between Trains</u>	07 30 to 18 00. Bridgework (No. 6). 12m. 26chs. Crane and mechanical equipment in use. (85/62)
268	Woodgrange Park and Barking Tilbury Line Jn West	Down and Up	Erecting scaffolding in connection with bridge No. 14A. (85/8)

SUNDAY 21 SEPTEMBER

269	Forest Gate Jn and Barking Station (Country End)	All BLOCKED to electric trains	00 50 to 06 15. In connection with engineering work between Woodgrange Park Jn and Barking Tilbury Line Jn West. <u>Isolation of electrical sections 512 and 513.</u>
-----	--	-----------------------------------	---

SECTION B - TEMPORARY ENGINEERING WORKS - continued

At or between	Lines affected	Remarks
---------------	----------------	---------

UPPER HOLLOWAY TO BARKING, TILBURY LINE JN WEST - continued

SUNDAY 21 SEPTEMBER - continued

270	Woodgrange Park Jn and Barking Tilbury Line Jn West	Down and Up BLOCKED	00 50 to 06 15. Bridgework (No. 14A). Crane and mechanical equipment in use. <u>Possession to be given up for passage of Engineers' trains.</u>
-----	---	------------------------	---

BARKING, TILBURY LINE JN EAST TO TILBURY RIVERSIDE

UNTIL FURTHER NOTICE

271	Dagenham Dock Station	Down and Up	08 00 to 17 00. Construction work. Mechanical equipment in use. (85/14)
272	Rainham Station	Down and Up	08 00 to 17 00. Construction work. Mechanical equipment in use. (85/14)
273	Purfleet Station	Down and Up	09 00 to 16 00. Platform work. Mechanical equipment in use. (85/61)

SUNDAY 21 SEPTEMBER

274	Barking Tilbury Line Jn East and West Thurrock Jn.	Down and Up Main BLOCKED	00 35 to 22 00. Track maintenance, formation renewal, undertrack excavation, drainage, overhead line work and demolition work. Mechanical equipment in use. <u>Isolation of electrical sections 530, 531, 532AB, 533DE. 0M52 21 00 Ripple Lane to Tilbury RCT to travel over Up Goods line and to be diverted via Barking and Upminster. Other trains diverted via Upminster.</u>
275	Grays and Tilbury Riverside/ Tilbury East Jn	All BLOCKED	00 40 to 16 00. Track maintenance. Mechanical equipment in use.

SECTION B - TEMPORARY ENGINEERING WORKS - continued

At or between	Lines affected	Remarks
---------------	----------------	---------

BARKING, TILBURY LINE JN EAST TO TILBURY RIVERSIDE - continued

SUNDAY 21 SEPTEMBER - continued

276	Rainham and Thames Haven Jn	All BLOCKED to electric trains	01 15 to 04 15. In connection with overhead line work between Grays and Tilbury Town. <u>Isolation of electrical sections 532, 533, 534 and 535.</u>
277	Grays and Tilbury Town	Down and Up BLOCKED	01 15 to 04 15. Overhead line work. <u>Possession to be given up for passage of Diesel trains.</u>

MONDAY 22 TO WEDNESDAY 24 SEPTEMBER

278	Purfleet and West Thurrock Jn	Down BLOCKED	23 35 Mon and Tue to 04 30 Tue and Wed. Track maintenance. Mechanical equipment in use. <u>Single line working over Up line.</u>
-----	-------------------------------	--------------	--

THURSDAY 25 SEPTEMBER

279	Upminster and Grays	Single/Up/Third line BLOCKED	00 30 to 04 30. Track maintenance. Mechanical equipment in use.
-----	---------------------	------------------------------	---

TILBURY WEST JN TO TILBURY EAST JN

SUNDAY 21 SEPTEMBER

280	Grays and Tilbury Riverside/Tilbury East Jn	All BLOCKED	00 40 to 16 00. Track maintenance. Mechanical equipment in use.
-----	---	-------------	---

MONDAY 22 SEPTEMBER

281	Rainham and Thames Haven Jn	All BLOCKED to electric trains	01 15 to 04 15. In connection with overhead line work between Grays and Tilbury Town. <u>Isolation of electrical sections 532, 533, 534 and 535.</u>
-----	-----------------------------	--------------------------------	--

SECTION B - TEMPORARY ENGINEERING WORKS - continued

At or between	Lines affected	Remarks
---------------	----------------	---------

TILBURY RIVERSIDE TO PITSEA

SUNDAY 21 TO MONDAY 22 SEPTEMBER

282 Thames Haven Jn and Pitsea	All BLOCKED	01 10 Sun to 02 30 Mon. Level crossing work (Fobbing and Pitsea Hall LCs) and overhead line work. Crane and mechanical equipment in use. <u>Isolation of electrical sections 536 and 537.</u>
--------------------------------	----------------	---

MONDAY 22 SEPTEMBER

283 Rainham and Thames Haven Jn	All BLOCKED to electric trains	01 15 to 04 15. In connection with overhead line work between Grays and Tilbury Town. <u>Isolation of electrical sections 532, 533, 534 and 535.</u>
---------------------------------	--------------------------------------	--

UPMINSTER TO WEST THURROCK JN

THURSDAY 25 SEPTEMBER

284 Upminster and Grays	Single/Up/ Third line BLOCKED	00 30 to 04 30. Track maintenance. Mechanical equipment in use.
-------------------------	-------------------------------------	---

SECTION CSIGNALLING AND PERMANENT WAY ALTERATIONS

* * Items marked thus will not appear in future issues and a note must be
 * taken of them by all concerned.

DETAILS OF WORK REFERRED TO IN SECTION BSUNDAY 21 SEPTEMBER - TROWSE UPPER JUNCTION AND TROWSE LOWER JUNCTIONTrowse Upper Junction

Trowse Upper Junction Signal Box, together with all signals worked therefrom will be abolished. All points previously worked therefrom including the Siding line to Victoria Goods Depot will be secured out of use pending removal.

(The catch points will be unaffected at this stage).

The Block Section will then be between Swainsthorpe and Trowse Lower Junction.

Trowse Lower JunctionSignalling Alterations

A new Trowse Lower Junction Down Main Distant plated TL47 (3-aspect colour light signal exhibiting Yellow or Green aspect only at this stage) will be provided 1,500 yards before reaching the Trowse Lower Junction Down Home signal TL45. (This new Distant signal will be 700 yards further from TL45 signal than was the former Trowse Upper Junction Down Main Starting signal TU20 which incorporated the Trowse Lower Junction Down Distant).

An Automatic Warning System track inductor will be provided in conjunction with TL47 new colour light Distant signal.

(29)

SUNDAY 21 SEPTEMBER - NORWICH THORPE JUNCTION

Line 'A'/'E' will be realigned nearer to Line 'B', between Carrow Road Bridge and the Up/Down Lowestoft lines crossovers at Thorpe Junction. The associated redundant trap points and sand-drag will be removed.

(29)

MONDAY 22 SEPTEMBER - GISSING LEVEL CROSSING AT 98m 57chs (between Diss and Tivetshall

The level crossing gates will be removed and the crossing converted to one with automatic half-barriers.

Telephone communication will be provided between the crossing and Diss signalbox (previously to Tivetshall).

SECTION C - SIGNALLING AND PERMANENT WAY ALTERATIONS - continuedDETAILS OF WORK REFERRED TO IN SECTION B - continuedMONDAY 22 SEPTEMBER - GISSING LEVEL CROSSING AT 98m 57chs (between Diss and Tivetshall - continuedWorking in wrong direction

The barriers will be equipped to work automatically when approached in the reverse direction and for this purpose a combined St. Andrew's Cross/50 m.p.h. speed restriction sign will be provided 954 yards from the crossing applicable to each rail approach in the wrong direction.

(29)

MONDAY 22 SEPTEMBER - NEWTON FLOTMAN LEVEL CROSSING AT 108m. 19chs. (between Tivetshall and Swainsthorpe)

The level crossing gates will be removed and the crossing converted to one with Automatic half-barriers.

The crossing will be closed to road traffic and the barriers secured in the lowered position until the associated road works are completed when the barriers will be fully commissioned.

Telephone communication will be provided between the level crossing and Swainsthorpe signalbox.

Working in wrong direction

The automatic half-barriers will be equipped to work automatically when approached in the wrong direction, and for this purpose a combined St. Andrews Cross/50 m.p.h. speed restriction sign will be provided 1,003 yards from the crossing applicable to each rail approach in the wrong direction.

(29)

WEDNESDAY 24 SEPTEMBER - UFFORD LEVEL CROSSING AT 81M. 60CHS. (East Suffolk Line)

The combined St. Andrews Cross/speed restrictions sign  on the

Up approach to Ufford level crossing will be replaced by an  sign

476 yards before reaching the crossing.

(29)

SECTION C - SIGNALLING AND PERMANENT WAY ALTERATIONS - continuedDETAILS OF WORK ALREADY CARRIED OUTNEW HALL

The Up Loop has been taken out of use Until Further Notice.

(UFN)

HATFIELD PEVEREL

The facing and trailing crossovers are out of use until further notice.

(UFN)

THORPE JUNCTION

The lines leading into Line 'C' (Up Main) at Thorpe Junction have been remodelled resulting in Line 'B' (Up Lowestoft) and Nos. 1 and 2 Receptions being realigned.

The Headshunt associated with Nos. 1 and 2 Reception lines has been abolished.

(27)

THORPE JUNCTION AND NORWICH STATION

An elevated double-sided "OFF" indicator plated NO 1785/1787R has been provided on the left-hand side of line 'A'/'E', 80 yards on the Whittingham Junction side of Carrow Road Bridge.

The indication 'OFF' will be illuminated when either position light signal NO 1785 (Line 'C') or NO 1787 (Line 'E') has been cleared.

(27)

SNAILWELL (Between Chippenham Junction and Soham)

A new trailing connection has been brought into use in the Up line at 3m.p. leading to Firmin Coates Private Siding.

Operation is by two-lever ground frame released from Chippenham Junction signalbox. (Telephone communication has been provided between the ground frame and signalbox).

(28)

SECTION D

GENERAL INSTRUCTIONS AND NOTICES

A thick vertical line denotes new or amended items.

** Items marked thus will not appear in future issues and a note must be taken of them by all concerned.
*

EASTERN REGION SECTIONAL APPENDIX (SOUTHERN AREA)

TABLE A : DETAILS OF RUNNING LINES

Running Lines and Signalling System	Location	M. Ch.	Permanent Speed Restrictions		Remarks
			Down m.p.h.	Up m.p.h.	
<u>LIVERPOOL STREET TO NORWICH</u>					
<u>Page 60</u>					
<u>Delete:-</u>	Ardley End LC	97 00			
<u>Substitute :-</u>	Audley End (Norfolk) LC (AHB-X)	97 05	X50	X50	<u>Approaching level crossing in wrong direction.</u> (10.SD)
<u>Amend :-</u>	Gissing LC (AHB-X)	98 57	X50	X50	<u>Approaching level crossing in wrong direction.</u> (w.e.f. Monday 22 September).
<u>Amend :-</u>	Newton Flotman LC (AHB-X)	108 19	X50	X50	<u>Approaching level crossing in wrong direction.</u> (w.e.f. Sunday 21 September).

SE-50

SECTION D - GENERAL INSTRUCTIONS AND NOTICES - continued

EASTERN REGION SECTIONAL APPENDIX (SOUTHERN AREA) - continued

Running Lines and Signalling System	Location	M. Ch.	Permanent Speed Restrictions		Remarks
			Down m.p.h.	Up m.p.h.	
<u>LIVERPOOL STREET TO NORWICH - continued</u>					
<u>Page 61</u>					
<u>Delete all details between Swainsthorpe and Trowse Lower Jn and substitute :-</u>					
	Swainsthorpe LC	109 54		<u>90</u> <u>111m. 15chs. and 110m. 55chs.</u> <u>80</u> <u>111m. 15chs. and 112m. 62chs.</u> <u>40</u> <u>112m. 62chs. and 113m. 46chs.</u>	C. Up at 113m. 21chs. C. Up at 113m. 61chs. (395 yards before reaching Trowse Lower Jn Starting Signal).
	Trowse Lower Jn (see page 103)	<u>113 68</u> <u>123 00</u>	<u>35</u>	<u>113m. 46chs. and 123m.p.</u>	
					(w.e.f. Sunday 21 September). (10.SD)

SE-51

SECTION D - GENERAL INSTRUCTIONS AND NOTICES - continued

EASTERN REGION SECTIONAL APPENDIX (SOUTHERN AREA) - continued

Running Lines and Signalling System	Location	M. Ch.	Permanent Speed Restrictions		Remarks
			Down m.p.h.	Up m.p.h.	
<u>WICKFORD JN. TO SOUTHMINSTER</u> Page 68 (Page 20, SD.PON) At Southminster Add:-			15	15	<u>45m. 23chs. and 45m. 42chs.</u> (10.SD)
<u>EAST SUFFOLK JN TO OULTON BROAD NORTH JN</u> Page 73 (Page 23, SD.PON) Amend :-	Ufford LC (AOCL)	81 60	50	50	<u>Approaching level crossing.</u> <u>(w.e.f. Wednesday 24 September)</u> (10.SD)

SE-52

SECTION D - GENERAL INSTRUCTIONS AND NOTICES - continued

EASTERN REGION SECTIONAL APPENDIX (SOUTHERN AREA) - continued

Running Lines and Signalling System	Location	M. Ch.	Permanent Speed Restrictions		Remarks
			Down m.p.h.	Up m.p.h.	
<p><u>NORWICH TO LOWESTOFT</u></p> <p>Page 78 (Page 44, JN)</p> <p>Delete all details between Norwich Thorpe Jn and Whittingham Jn and substitute :-</p>					
	Norwich	0 00	15		<u>All lines. 0m.p. and 0m. 38chs.</u>
	Norwich (NO)	0 23			Norwich (NO) signal box area between Norwich and Crown Point.
	Thorpe Jn (See page 61)	0 29			

SECTION D - GENERAL INSTRUCTIONS AND NOTICES - continued

EASTERN REGION SECTIONAL APPENDIX (SOUTHERN AREA) - continued

Running Lines and Signalling System	Location	M. Ch.	Permanent Speed Restrictions		Remarks
			Down m.p.h.	Up m.p.h.	
<p><u>NORWICH TO LOWESTOFT - continued</u></p> <p><u>Page 78 (Page 44, SD PON) - continued</u></p> <p><u>Delete all details between Norwich Thorpe Jn and Whitlingham Jn and substitute - continued :-</u></p>					
		0 35			
	Crown Point	0 60		15	<u>All lines. 0m. 38chs. and 0m.p.</u>
	Whitlingham Jn (WH) (See page 79)	1 69	<u>25</u>		<u>To Cromer line.</u>
					URS 55. (10.SD)

SE-54

SECTION D - GENERAL INSTRUCTIONS AND NOTICES - continued

EASTERN REGION SECTIONAL APPENDIX (SOUTHERN AREA) - continued

Running Lines and Signalling System	Location	M. Ch.	Permanent Speed Restrictions		Remarks
			Down m.p.h.	Up m.p.h.	
<u>Page 81</u>					
<u>REEDHAM JN TO YARMOUTH</u>					
At Berney Arms					
<u>Delete :-</u>			30	30	<u>15m.p. and 19m. 24chs.</u>
<u>Substitute :-</u>			30	30	<u>13m. 52chs. and 19m. 24chs.</u>
					(10.SD)

SECTION D - GENERAL INSTRUCTIONS AND NOTICES - continuedEASTERN REGION SECTION APPENDIX (SOUTHERN AREA) - continuedOTHER GENERAL INSTRUCTIONS

Page 297

Add :- DOCKLANDS LIGHT RAILWAY LINE BETWEEN BOW JN AND STRATFORD STATION
(ADJACENT TO THE B.R. UP ELECTRIC LINE)

B.R. staff must observe the provisions of the previous instructions on pages 294 to 297 headed, "Instructions to Traincrews Working other than D.C. Electric trains and other staff concerned working over or in the vicinity of D.C. Electrified lines", except that reference to Electrical Control Operator should be read as Controller and Supervisor at Poplar Control Centre, who can be contacted via the Signaller at Bow Jn or on British Telecom 538 3440.

The Docklands Light Railway when fully operational will work automatically without lineside signals, using Driverless trains which will approach in either direction travelling at a maximum speed of 50m.p.h. Each train will convey a member of Docklands Light Railway staff called a "Train Captain".

Docklands trains will not sound a warning to persons on or near the line, etc. and B.R. Staff must not, therefore, except in emergency go onto the Docklands Light Railway. Posts are provided in the 10 Foot between the Up Electric line and the Docklands line to identify the point beyond which staff must not proceed. When staff stand clear of the Up Electric line they must align themselves between the posts.

In the vicinity of the Bow Junction signal box and overbridge 609 (Fairfield Road), Staff must not, except in emergency, proceed beyond the fence between the B.R. and Docklands line. If unavoidable circumstances compel staff to remain between the B.R. and Docklands lines when trains pass, they must lay down against the B.R. side of the fence. It is important that this instruction is observed as the collector shoes of Docklands Light Railway trains will pass in close proximity to the Docklands side of the fence.

If an emergency/mishap occurs on B.R. lines requiring the stopping of trains on the Docklands Light Railway, standard B.R. protection arrangements must be observed and advice given to the Poplar Control Centre by the quickest available means. It should be noted that the placing of a Track Circuit Operating Clip on the Docklands line will stop a train which is in automatic mode.

(10.SD)

SECTION D - GENERAL INSTRUCTIONS AND NOTICES - continuedEASTERN REGION SECTIONAL APPENDIX (SOUTHERN AREA) - continuedLOCAL INSTRUCTIONSINDEX

<u>Page 301</u>		<u>Page</u>
! <u>Add:-</u>		
Oulton Broad South and Beccles - Between		322

LOCAL INSTRUCTIONS

Page 322 EAST SUFFOLK JN TO OULTON BROAD NORTH JN

Add:- BETWEEN OULTON BROAD SOUTH AND BECCLES

2J49 16 25 Lowestoft-Beccles train is authorised to proceed from Oulton Broad South to Beccles and return from that location to Oulton Broad South displaying the Oulton Broad South to Halesworth Full token throughout.

The Driver must obtain the permission of the Signalman at Saxmundham for the train to return from Beccles to Oulton Broad South. The token now being displayed in the rear cab.

On arrival at Oulton Broad South, the Driver must proceed to the rear cab, carry out the token return procedure and then proceed forward in the normal manner.

(10.SD)

Page 316 SILVERTOWN

Delete instruction and substitute :-

Thomas W. Ward and Co. Private Siding

Loaded or empty 4-wheeled vehicles with a wheelbase exceeding 10' 6" (3.2m) (with the exception of POA vehicles), 80 to 100t AB 4-axled bogie vehicles and 6-wheeled vehicles must not be taken into this private siding.

POA 51t GLW open scrap wagons may be worked singly into this siding at dead slow speed, but only so far as the firms' wagon weighbridge for weighing purposes.

BCV, BDV, BEV, BPV and BQV's must be shunted into this siding at dead slow speed.

(10.SD)

SECTION D - GENERAL INSTRUCTIONS AND NOTICES - continuedMISCELLANEOUS NOTICESMAXIMUM PERMISSIBLE SPEEDS OF FREIGHT ROLLING STOCK :
21.5T CAPACITY MINERAL WAGONS

The maximum speed of all MDO, MDV and ZDV/ZHV wagons, which are ex traffic MD wagons, has been reduced to 45m.p.h. in all conditions.

The basic panels for these wagons on Page C30 of the White Pages of the Working Manual for Rail Staff are amended accordingly.

(UFN)

WORKING OF CLASS 313 AND CLASS 416 ELECTRIC MULTIPLE UNIT
TRAINS BETWEEN DALSTON WESTERN JN AND STRATFORD MARKETClass 313 Electric Multiple Units

These units must only work between Navarino Road Jn and Stratford Market stabling sidings when either the Graham Road Curve route to Liverpool Street is not available, or when the pantographs have failed to rise. When operating between Dalston Kingsland and Stratford Market stabling sidings and return in the D.C. mode, Drivers must not advance the controller beyond Notch 2.

THESE UNITS MUST NOT RUN BEYOND STRATFORD MARKET TOWARDS NORTH WOOLWICH.

Class 416 Electric Multiple Units

Not more than two Class 416 units may be coupled together.

When two Class 416 units are running in multiple between Dalston Western Jn and Stratford Market, including the stabling sidings or return, Drivers must not advance the controller beyond Notch 2.

(UFN)

BETWEEN STEPNEY EAST AND FENCHURCH STREET

Until further notice, staff of the Docklands Light Railway will be laying in track adjacent to the Up Main/Slow line between Stepney East Station (lm. 58chs.) and Fenchurch Street. Restricted clearances exist and Drivers must keep a sharp look out and be prepared to sound the warning horn as necessary.

(UFN)

BETHNAL GREEN STATION

Until Further Notice, whilst demolition work is taking place, Drivers of 4-Car EMU trains must stop their trains at the temporary stop boards provided.

(UFN)

SECTION D - GENERAL INSTRUCTIONS AND NOTICES - continuedMISCELLANEOUS NOTICES - continuedDALSTON (KINGSLAND) STATION

The Down and Up platforms have been temporarily shortened at the Stratford end by 25 yards and only accommodate two coaches. Drivers of Down trains booked to stop at this station must bring their train to a stand at signal DW14/16. Drivers of Up trains booked to stop at this station must bring their train to a stand at the temporary stop board which has been provided adjacent to the footbridge.

(LM) (UFN)

HARWICH PARKESTON QUAY STATION

Until Further Notice, reconstruction work on Platform 2 will create hazards for passengers, including sub-standard surfaces and larger than normal gaps between the platform and train.

Special warning notices are to be exhibited and best use made of on-train and station announcing facilities to warn the Public of the danger.

(UFN)

CAMBRIDGE HEATH STATION

Whilst platform repairs are taking place, Drivers of trains must stop their trains at the temporary stop boards provided.

(UFN)

SAWBRIDGEWORTH STATION

The stop board on the Up platform has been temporarily moved 9 yards towards the Country side of its former position.

(UFN)

WANSTEAD PARK STATION

Whilst platform repairs are taking place, Drivers of Up trains must stop their trains at the temporary stop boards provided.

(UFN)

SECTION D - GENERAL INSTRUCTIONS AND NOTICES - continuedMISCELLANEOUS NOTICES - continuedREPAIRS IN MOTIVE POWER DEPOTS, CARRIAGE SHEDS, WAGON REPAIR SHEDS AND WAREHOUSES

In connection with work being carried out at the undermentioned places, scaffolding or projections may be provided or unusual excavations may be made in the ground:-

Location	Nature of Work	Duration	Commencing date
Thornton Field Carr. M.D., All lines BLOCKED to electric trains	In connection with engineering work. <u>Isolation of electrical</u> <u>sections 433.</u>	From 23 30 <u>Friday 19</u> until 03 45 <u>Saturday 20</u> <u>September.</u>	-
Stratford Old Yard C.H.S., All lines BLOCKED to electric trains	In connection with engineering work. <u>Isolation of electrical</u> <u>sections 433.</u>	From 23 30 <u>Friday 19</u> until 03 45 <u>Saturday 20</u> <u>September.</u>	-
Stratford T.M.D. All lines.	Repairs to Motive Power Depot. Cranes and mechanical equipment in use.	Continuously. Until Further Notice.	-
Ilford EMU Depot, Nos. 19 and 20 Roads.	Drainage.	08 00 to 17 00 daily. Until Further Notice.	-
Ilford EMU Depot, Carriage Washer Roads BLOCKED	Renewal of carriage washer plant. <u>Isolation of electrical</u> <u>sections 361R.</u>	Continuously. Until Further Notice.	-
Gidea Park CS, Nos. 1 to 5 inc. Sidings BLOCKED to electric trains	Construction work, <u>Isolation of electrical</u> <u>sections 326DE.</u>	00 10 to 05 15. <u>Saturday 20</u> <u>September.</u>	-
Norwich Crown Point T & R.S. M.D., All lines BLOCKED	Construction work (overhead line) and track maintenance. Mechanical equipment in use. <u>Possession</u> <u>to be given up for</u> <u>passage of trains.</u>	08 00 to 17 00 daily. Until further notice.	-

SECTION D - GENERAL INSTRUCTIONS AND NOTICES - continuedMISCELLANEOUS NOTICES - continuedREPAIRS IN MOTIVE POWER DEPOTS, CARRIAGE SHEDS, WAGON REPAIR SHEDS AND WAREHOUSES - continued

In connection with work being carried out at the undermentioned places, scaffolding or projections may be provided or unusual excavations may be made in the ground:-

Location	Nature of Work	Duration	Commencing date
Coldham Lane Carriage Sidings, No. 4 and 5 Sidings BLOCKED	Track renewal. Crane and mechanical equipment in use.	Continuously.	From 21 00 <u>Saturday 20</u> until 08 00 <u>Sunday 21</u> <u>September.</u>
East Ham EMU Depot, All lines.	Shed reconstruction.	Continuously. Until Further Notice.	-
East Ham EMU Depot, Washer Road BLOCKED	Repairs to washer plant. <u>Isolation of</u> <u>electrical sections</u> <u>509A.</u>	Continuously. Until Further Notice.	-
East Ham EMU Depot, All lines BLOCKED	Overhead line work. <u>Isolation of electrical</u> <u>sections 509.</u>	00 30 to 17 30. <u>Sunday 21</u> <u>September.</u>	-

MP.32/SE
YORK
11 SEPTEMBER, 1986

C. McKEEVER
Regional Operations Manager

BRITISH RAIL
EASTERN REGION

SE

27

WEEKLY OPERATING NOTICE

CONTAINING

TEMPORARY SPEED RESTRICTIONS

TEMPORARY ENGINEERING WORKS

SIGNALLING AND
PERMANENT WAY ALTERATIONS

GENERAL INSTRUCTIONS AND NOTICES

SATURDAY 27 SEPTEMBER

TO

FRIDAY 3 OCTOBER 1986

INCLUSIVE

Trainmen must pay particular attention to works contained in this notice and keep a good look-out for handsignals which may be exhibited in accordance with the Rules and Regulations.

Work at places other than those mentioned may be in progress and Drivers must be on the look-out and be prepared to stop or run at reduced speed when, and where, handsignals may be exhibited.

SECTION A

TEMPORARY SPEED RESTRICTIONS

(Until further notice unless otherwise specified)

Warning Boards and Indicators provided unless otherwise shown.

† Indicates that the Warning Boards and Indicators will be moved as the work progresses. Where two speeds are shown for a restriction e.g. $\frac{20}{40}$ the Rule

Book, Section U, Clause 1.2 applies.

Location	Lines affected		Mileage		Restr- iction m.p.h.	Remarks
			M. Ch.	M. Ch.		
<u>LIVERPOOL STREET TO NORWICH</u>						
1 Ilford Car Sheds and Goodmayes Station	Down Main	-	8 37	8 55	20	Trackwork. <u>Warning board</u> <u>also provided</u> <u>on Down</u> <u>Electric</u> <u>line at 7m.</u> <u>72chs.</u> (86/23)
2 Goodmayes Station and Ilford Car Sheds	-	Up Main	8 55	8 37	20	Trackwork. <u>Warning board</u> <u>also provided</u> <u>on Up</u> <u>Electric</u> <u>line at 9m.</u> <u>23chs.</u> (86/23)
3 Romford and Gidea Park Station	Down Electric	Up Electric	12 15	12 48	20	Trackwork. (86/24)
4 Harold Wood and Brentwood	Down Main	-	15 02	15 42	$\frac{20}{40}$	Condition of track. (85/61)
5 Brentwood and Ingatstone	Down Main	-	19 65	20 33	50	Condition of track. (86/14)
6 Church Lane LC and Chelmsford	Down	Up	29 24	29 57	20	Trackwork. (86/26)
7 Chelmsford and New Hall G.F.	Down	-	30 50	30 65	50	Condition of track. (86/12)

SECTION A - TEMPORARY SPEED RESTRICTIONS - continued

Location	Lines affected		Mileage		Restr- iction m.p.h.	Remarks
			at or between M. Ch. M. Ch.			
<u>LIVERPOOL STREET TO NORWICH - continued</u>						
8 New Hall G.F. and Hatfield Peveler	Down	-	35 10 †	35 40	40	Trackwork. (86/26)
9 Hatfield Peveler - and New Hall G.F.	-	Up	35 27	35 22	40	Earthwork. <u>From 09 00</u> <u>Monday 29</u> <u>September</u> <u>until 14 00</u> <u>Friday 3</u> <u>October.</u>
10 New Hall G.F. and Witham	Down	-	35 40 †	38 40	60	Trackwork. (86/26)
11 Kelvedon	-	Up	42 25	42 10	<u>50</u> 80	Condition of track. (86/7)
12 Long Green LC and Marks Tey Jn	Down	-	46 36	46 55	20	Earthwork. (86/23)
13 Marks Tey Jn and Long Green LC	-	Up	46 55	46 36	30	Earthwork. <u>From 07 00</u> <u>until 16 00</u> <u>Sunday 28</u> <u>September.</u>
14 Barham and Baylham LC	Down	Up	74 70	75 05	30	Bridgework. (No. 262). (86/26)
15 Diss and Audley End LC	Down	Up	95 10	95 15	20	Bridgework (No. 315). (86/26)
16 Swainsthorpe and Trowse Lower Jn	Down	Up	112 30	112 70	30	Trackwork. <u>Until 10 00</u> <u>Monday 29</u> <u>September.</u> (86/26)
17 Swainsthorpe and Trowse Lower Jn	Down	-	112 30	112 70	30	Trackwork. <u>From 10 00</u> <u>Monday 29</u> <u>September.</u> (86/27)

SECTION A - TEMPORARY SPEED RESTRICTIONS - continued

Location	Lines affected		Mileage		Restr- iction m.p.h.	Remarks	
			at or between M. Ch. M. Ch.				
<u>SHENFIELD JN TO SOUTHEND VICTORIA</u>							
18	Billericay and Wickford Station	Down	-	26 10	26 44	40	Condition of track. (86/14)
19	Wick Lane LC and Rayleigh	Down	-	31 35	31 75	40	Condition of embankment. (84/41)
<u>WICKFORD JN TO SOUTHMINSTER</u>							
20	Althorne LC and Burnham-on- Crouch	Single		41 10 †	42 10	20	Trackwork. (85/45)
<u>COLCHESTER TO CLACTON</u>							
21	Colchester Road LC and Wivenhoe	-	Up	57 72 †	57 12	40	Condition of track. (86/26)
<u>MANNINGTREE SOUTH JN TO HARWICH</u>							
22	Bradfield LC and Wrabness	Down	-	63 37	63 39	40	Earthwork. (85/55)
23	Parkeston Goods Jn and Wrabness	-	Up	66 70	66 10	<u>30</u> 50	Condition of track. (86/3)
<u>EAST SUFFOLK JN TO OULTON BROAD NORTH JN</u>							
24	Bealings LC and Westerfield Jn	-	Up	74 60 †	73 44	20	Trackwork. (86/21)
<u>NORWICH TO LOWESTOFT</u>							
25	Thorpe Jn and Whitlingham Jn	Down	Up	0 36	0 44	20	Trackwork. (85/20)

SECTION A - TEMPORARY SPEED RESTRICTIONS - continued

Location	Lines affected	Mileage at or between		Restr- iction m.p.h.	Remarks
		M. Ch.	M. Ch.		
<u>BETHNAL GREEN JN TO KING'S LYNN</u>					
26 Cambridge Heath	Down Suburban	Up Suburban	1 57	1 67	20 Platform work. (86/24)
27 Brimsdown and Waltham Cross	Down	Up	11 54	12 12	20 Trackwork. (86/11)
28 Cheshunt Station and Wharf Road LC	Down	-	15 12 †	15 79	40 Trackwork. (86/26)
29 Wharf Road LC and Cheshunt Station	-	Up	15 79 †	15 12	30 Trackwork. (86/26)
30 Sawbridgeworth and Harlow Mill	-	Up	24 76	24 70	60 Condition of track. (86/16)
<u>COLDHAM LANE JN TO HAUGHLEY JN</u>					
31 Elmswell and Haughley Jn	Down	-	37 15 †	38 00	20 Trackwork. (86/22) <u>Until 10 00</u> <u>Monday 29</u> <u>September.</u>
32 Elmswell LC and Haughley Jn	Down	-	37 15 †	38 00	30 Trackwork. <u>From 10 00</u> <u>Monday 29</u> <u>September.</u> (86/27)
<u>ELY NORTH JN TO PETERBOROUGH, CRESCENT JN</u>					
33 Third Drove LC and Welney Road LC	Down	Up	78 00	78 18	20 Condition of track. (86/21)
34 Third Drove LC and Welney Road LC	Down	Up	78 42	78 60	20 Condition of track. (86/21)

SECTION A - TEMPORARY SPEED RESTRICTIONS - continued

Location	Lines affected		Mileage		Restr- iction	Remarks
			M. Ch. M. Ch.	m.p.h.		
<u>ELY NORTH JN TO PETERBOROUGH, CRESCENT JN - continued</u>						
35 March East Jn and Badgeney Road LC	-	Up Main	85 40	85 29	20	Trackwork. (85/54) <u>Warning board positioned at signal ME.45. Additional warning board provided on the March East Jn to Wisbech line, positioned at signal ME.52.</u>
36 Three Horse Shoes No. 3 LC	Down	Up	90 74	90 78	<u>20</u> 50	Condition of track. (86/24)

Warning board at 100m. 23chs. (on the Down line) applies only to trains proceeding over the Two-Way Goods line to Fly Ash Inspection Siding connection at Peterborough Station (North).

ELY NORTH JN TO TROWSE LOWER JN

37 Eaton LC and Trowse Lower Jn	Down	Up	121 60	121 64	20	Bridgework (Nos. 1640 and 1640A). (86/23)
------------------------------------	------	----	--------	--------	----	--

UPPER HOLLOWAY TO BARKING, TILBURY LINE JN WEST

38 South Tottenham East Jn and Black Horse Road	Down	-	6 45	6 57	20	Condition of track. (85/18)
---	------	---	------	------	----	-----------------------------------

BARKING, TILBURY LINE JN EAST TO TILBURY RIVERSIDE

39 Jurgens LC and West Thurrock Jn	Down	Up	17 20	17 30	20	Trackwork. (86/26)
---------------------------------------	------	----	-------	-------	----	-----------------------

SECTION A - TEMPORARY SPEED RESTRICTIONS - continued

Location	Lines affected	Mileage		Restr- iction	Remarks
		at or between			
		M. Ch.	M. Ch.	m.p.h.	
<u>TILBURY RIVERSIDE TO PITSEA</u>					
40 Stanford-le- Hope and Gardners LC	Down -	30 11	30 60	40	Condition of track. (86/1)

SECTION B

TEMPORARY ENGINEERING WORKS

At or between	Lines affected	Remarks
<u>LIVERPOOL STREET TO NORWICH</u>		
UNTIL FURTHER NOTICE		
41	Liverpool Street Station Platforms 1 to 10 Inc.	Repairs to station roof. Mechanical equipment in use. (84/41)
42	Liverpool Street Station Platforms 1 to 18 inc.	Cleaning track. (85/21)
43	Liverpool Street Station Platforms 8, 10 and 11 to 18 inc.	Platform work and construction work. Mechanical equipment in use. (86/21)
44	Bethnal Green Station Down Main and Down and Up Suburban	08 00 to 16 00. Demolition work. (<u>See Section 'D'</u>). (85/41)
45	Bethnal Green and Bow Jn All	Signalling work. (86/25)
46	Stratford and Bow Jn Up Electric	07 30 to 18 00. Construction work. Mechanical equipment in use. (85/62)
47	Forest Gate Jn and Ilford All	07 00 to 18 00. Bridgework (No. 75A), 7m. 08chs. Mechanical equipment in use. (85/20)
48	Ilford Station All	08 00 to 17 00. Repairs to station roof and painting station. (86/2)
49	Romford Jn and Gidea Park All	Bridgework (No. 102B). 12m. 48chs. Crane and mechanical equipment in use. (85/54)
50	Ingatestone and Chelmsford Down and Up	07 30 to 18 00. Construction of bridge (No. 143A) 26m. 51chs. Mechanical equipment in use. (84/35)
51	Chelmsford and Hatfield Peverel Down and Up	07 30 to 16 00. Earthwork 35m. 53chs. (85/27)
52	Colchester Jn and Ardleigh LC Down Main	08 00 to 17 00. Earthwork and formation renewal. 52m. 25chs. and 53m. 75chs. Mechanical equipment in use. (85/41)

SECTION B - TEMPORARY ENGINEERING WORKS - continued

At or between	Lines affected	Remarks	
<u>LIVERPOOL STREET TO NORWICH - continued</u>			
UNTIL FURTHER NOTICE - continued			
53	Manningtree North Jn and Bentley LC	Down and Up <u>Between Trains</u>	07 00 to 18 00. Tree felling, bridgework (No. 229) and earthwork. 60m. 06chs. and 61m. 06chs. Crane and mechanical equipment in use. (85/15)
* 54	Ipswich Goods Jn and Needham Market	Down Main	08 00 to 16 00. Construction work. 69% and 76m.p. (86/19)
55	East Suffolk Jn and Claydon LC	Down and Up	08 00 to 16 00. Bridgework (No.254A). 70m. 17chs. (85/58)
56	Barham and Baylham LC	Down and Up	Bridgework (No. 262). 74m. 73chs. Mechanical equipment in use. <u>From 23 00 Saturday 27 September.</u> (86/27)
57	Mellis	Down and Up	07 30 to 18 00. Demolition work. 91 $\frac{1}{2}$ m.p. Mechanical equipment in use. (86/12)
58	Mellis and Trowse Lower Jn	All <u>Between Trains</u>	07 30 to 18 00. Signalling work. Points and signals disconnected. (86/15)
59	Diss and Mellis	Up	08 00 to 15 00. Construction work. 94m. 05chs. and 94m.p. (86/17)
60	Diss	Down and Up	07 00 to 19 00. Earthwork. Crane and mechanical equipment in use. (85/27)
61	Diss and Audley End LC	Down and Up	Bridgework (No. 315). 95m. 29chs. (86/16)
62	Diss and Tivetshall Jn	Down and Up	07 30 to 18 00. Demolition work 97m 50chs. Mechanical equipment in use. (86/12)
63	Gissing LC	Down and Up	08 00 to 16 00. Level crossing road repairs. 98m. 56chs. Mechanical equipment in use. (86/26)
64	Tivetshall Jn	Down and Up	07 30 to 18 00. Demolition work. 100% $\frac{1}{2}$ m.p. Mechanical equipment in use. (86/8)

SECTION B - TEMPORARY ENGINEERING WORKS - continued

<u>At or between</u>	<u>Lines affected</u>	<u>Remarks</u>
<u>LIVERPOOL STREET TO NORWICH - continued</u>		
UNTIL FURTHER NOTICE - continued		
65 Tivetshall Jn and Swainsthorpe	Down and Up <u>Between Trains</u>	07 30 to 18 00. Bridgework (Nos. 328 and 331A) and demolition work. 103m. 13chs. and 104m. 59chs. Crane and mechanical equipment in use. (86/8)
66 Newton Flotman LC	Down and Up	08 00 to 16 00. Level crossing road repairs. 108m. 17chs. Mechanical equipment in use. (86/26)
67 Swainsthorpe	Down and Up <u>Between Trains</u>	07 30 to 18 00. Demolition work. 109 ³ / ₄ m.p. Mechanical equipment in use. (86/8)
68 Swainsthorpe and Trowse Lower Jn.	Down and Up	07 00 to 16 00. Bridgework (No. 346) 110m. 62chs. Mechanical equipment in use. (86/25)
69 Trowse Lower Jn and Norwich Station	All <u>Between Trains</u>	07 00 to 17 00. Construction work (overhead line), earthwork, track maintenance and signalling work. Points and signals disconnected. (86/7)
70 Trowse Swing Bridge	Down and Up <u>Between Trains</u>	Bridgework (No. 356). 123m. 36chs. Crane and mechanical equipment in use. (85/33)
71 Trowse Swing Bridge and Thorpe Jn	Down and Up <u>Between Trains</u>	07 30 to 18 00. Construction work. 123 ¹ / ₄ m.p. Crane and mechanical equipment in use. (86/3)
72 Norwich Station	All	Track renewal, platform work and earthwork. Crane and mechanical equipment in use. (85/62)

SATURDAY 27 SEPTEMBER

73 Bethnal Green and Bow Jn	Down and Up Main BLOCKED	00 10 to 05 00. Overhead line work. Mechanical equipment in use. <u>Isolation of electrical sections 311B, 312B. Trains to travel over Electric lines.</u>
-----------------------------	--------------------------------	---

SECTION B - TEMPORARY ENGINEERING WORKS - continued

<u>At or between</u>	<u>Lines affected</u>	<u>Remarks</u>
<u>LIVERPOOL STREET TO NORWICH - continued</u>		
SATURDAY 27 SEPTEMBER - continued		
74 Ilford Car Sheds (London End Jn) and Chadwell Heath Jn	Down and Up Main BLOCKED	09 30 to 18 00. Loading materials, bridgework (No. 84) and overhead line work. Crane in use. <u>Isolation of electrical sections 323B, 324D.</u> <u>Trains to travel over Electric lines.</u>
75 Colchester and Stanway G.F.	Up Main BLOCKED Platform 6 and Dock Road BLOCKED to electric trains	00 15 to 04 40. Track maintenance and overhead line work. Mechanical equipment in use. <u>Isolation of electrical sections 339CDJL.</u> <u>Single line working over Down Main line.</u>
75A Thorpe Jn	'A'/'E' line	20 00 to 22 00. Signalling work.
SATURDAY 27 TO SUNDAY 28 SEPTEMBER		
76 Chadwell Heath Jn and Gidea Park Station Jn	Down and Up Electric BLOCKED to electric trains	20 30 to 21 15 Sat)Track renewal,)formation)renewal, track)maintenance)and overhead 21 15 Sat to 22 00 Sun)line work.)Mechanical)equipment in)use. <u>Isolation</u>) <u>of electrical</u>) <u>sections 325DE,</u>) <u>326AB.</u>) <u>20 30 to 21 15</u>) <u>Sat. Electric</u>) <u>trains to</u>) <u>travel over</u>) <u>Main lines.</u>) <u>21 15 Sat to</u>) <u>22 00 Sun.</u>) <u>Trains to</u>) <u>travel over</u>) <u>Main lines.</u>
77 Diss and Swainsthorpe	Down and Up	07 00 Sat to 20 00 Sun. Signalling work (Tivetshall and Moulton LCs). <u>(See Section 'C').</u>

SECTION B - TEMPORARY ENGINEERING WORKS - continued

At or between	Lines affected	Remarks
---------------	----------------	---------

LIVERPOOL STREET TO NORWICH - continued

SATURDAY/SUNDAY 27/28 SEPTEMBER

78	Ilford Car Sheds (London End Jn) and Chadwell Heath Jn	Down and Up Main BLOCKED	23 00 to 19 00. Track renewal, track maintenance, painting Chadwell Heath Station and bridgework (No. 86). Crane and mechanical equipment in use. <u>Isolation of electrical sections 323B, 324D. Trains to travel over Electric lines.</u>
79	Trowse Lower Jn and Trowse Swing Bridge	Down and Up BLOCKED	23 55 to 07 00. Construction work (overhead line) and track renewal. <u>Possession to be given up for passage of 1P04 02 10 Liverpool Street to Yarmouth over Down line.</u>

SATURDAY/SUNDAY 27/28 AND SUNDAY 28 SEPTEMBER

80	Liverpool Street and Bethnal Green	Down and Up Suburban BLOCKED to electric trains	23 15 Sat to 18 00)Repairs to station)roof and overhead)work. Mechanical)equipment in use.) <u>Isolation of</u>
	Liverpool Street Station	Platforms 9 and 10 BLOCKED to electric trains	23 15 Sat to 04 15) <u>electrical</u>) <u>sections 305 and</u>) <u>306. Electric</u>) <u>trains to travel</u>) <u>over Main or</u>
		Platforms 1 to 8 inc. BLOCKED	23 15 Sat to 18 00) <u>Electric lines.</u>) <u>Trains to be</u>) <u>replatformed as</u>) <u>necessary.</u>
		Locomotive Holding Sidings BLOCKED to electric trains	23 15 Sat to 18 00))))
		Platforms 9 and 10 BLOCKED	04 15 to 18 00 Sun)))

SECTION B - TEMPORARY ENGINEERING WORKS - continued

At or between	Lines affected	Remarks
<u>LIVERPOOL STREET TO NORWICH - continued</u>		
SATURDAY/SUNDAY 27/28 AND SUNDAY 28 SEPTEMBER - continued		
81 Bethnal Green and Stratford (London End)	Down and Up Electric BLOCKED	23 00 Sat to 17 00)Track maintenance,)track renewal,)formation renewal,)unloading materials
Bethnal Green and Bow Jn	Up Main BLOCKED	00 15 to 06 00 Sun)and overhead line)work. Crane and
	Down and Up Main	08 00 to 18 00 Sun)mechanical)equipment in use.) <u>23 00 Sat to 00 15</u>) <u>Trains to travel</u>) <u>over Main lines.</u>) <u>23 00 Sat to 17 00</u>) <u>Isolation of</u>) <u>electrical sections</u>) <u>309A, 310B.</u>) <u>00 15 to 06 00 Sun</u>) <u>Isolation of</u>) <u>electrical sections</u>) <u>311B. Down trains</u>) <u>to travel over Down</u>) <u>Main line.</u>) <u>06 00 to 17 00 Sun</u>) <u>Trains to travel</u>) <u>over Main lines.</u>
82 New Hall G.F. and Witham	Up BLOCKED Down BLOCKED	23 15 Sat to 06 45)Track maintenance.)Mechanical 00 01 to 07 15 Sun)equipment in use.) <u>Possession to be</u>) <u>given up for</u>) <u>passage of 1Y02</u>) <u>02 20 Liverpool</u>) <u>Street to</u>) <u>Ipswich over Down</u>) <u>line.</u>

SECTION B - TEMPORARY ENGINEERING WORKS - continued

At or between	Lines affected	Remarks
---------------	----------------	---------

LIVERPOOL STREET TO NORWICH - continued

SATURDAY/SUNDAY 27/28 AND SUNDAY 28 SEPTEMBER - continued

83	Hill House G.F. and Stanway G.F.	Up Main BLOCKED Down Main BLOCKED	23 00 Sat to 07 30 00 01 to 16 00 Sun)Track maintenance,)formation renewal)and overhead line)work. Mechanical)equipment in use.) <u>23 00 Sat to 07 30</u>) <u>Possession to be</u>) <u>given up for</u>) <u>passage of 1Y02</u>) <u>02 20 Liverpool</u>) <u>Street to Ipswich</u>) <u>over Up Main line</u>) <u>under single line</u>) <u>working.</u>) <u>07 30 to 16 00 Sun.</u>) <u>Single line working</u>) <u>over Up Main line.</u>
84	Stowmarket Station (Country End) and Cow Green	Down and Up BLOCKED Down and Up	23 45 Sat to 07 15 07 15 to 16 00 Sun)Track maintenance)and level crossing)road repairs) <u>(Haughley LC).</u>)Crane and)mechanical)equipment in use.
85	Trowse Swing Bridge and Norwich	Crown Point Depot Nos. 1 and 2 Reception lines BLOCKED 'A'/'E' line BLOCKED 'B' line and 'C' line/ Up Main BLOCKED All	22 00 Sat to 07 00 22 00 Sat to 16 00 23 15 Sat to 07 00 16 00 to 18 00 Sun)Track maintenance,)track renewal and)signalling work.)Crane and)mechanical)equipment in use.) <u>Possession to be</u>) <u>given up for</u>) <u>passage of trains</u>) <u>over 'B' and 'C'</u>) <u>lines. (See</u>) <u>Section 'C').</u>

SECTION B - TEMPORARY ENGINEERING WORKS - continued

At or between	Lines affected	Remarks
---------------	----------------	---------

LIVERPOOL STREET TO NORWICH - continued

SATURDAY 27 TO MONDAY 29 SEPTEMBER

86	East Suffolk Jn and Haughley Jn	All BLOCKED to electric trains	08 00 Sat to 05 00 Mon. In connection with engineering work. <u>Isolation of electrical sections 345, 346, 347 and 348.</u>
----	---------------------------------	--------------------------------	---

87	Barham and Stowmarket	Down and Up <u>Between Trains</u> Down BLOCKED Up BLOCKED Down and Up <u>Between Trains</u>	08 00 to 23 00 Sat)Track 23 00 Sat to 01 00 Mon)maintenance, bridgework (No. 262) and 23 30 Sat to 01 00 Mon)overhead line work. Crane 01 00 to 05 00 Mon)and mechanical equipment in use. <u>Trains</u> <u>diverted via</u> <u>Cambridge and</u> <u>Ely.</u>
----	-----------------------	--	---

88	Diss and Tivetshall Jn	Down and Up BLOCKED	16 00 Sat to 04 00 Mon. Bridgework (No. 315), and track maintenance. Crane and mechanical equipment in use. <u>Trains diverted via Cambridge and Ely.</u>
----	------------------------	---------------------	---

89	Tivetshall Jn and Trowse Lower Jn	Down and Up BLOCKED	16 00 Sat to 04 00 Mon. Reballasting, signalling work, track maintenance, track renewal and construction work (overhead line). Mechanical equipment in use. <u>Trains diverted via Cambridge and Ely. (See Section 'C').</u>
----	-----------------------------------	---------------------	--

SUNDAY 28 SEPTEMBER

90	Shenfield and Stanway G.F.	All BLOCKED to electric trains	00 05 to 07 00. In connection with engineering work. <u>Isolation of electrical sections 333, 334, 335, 336, 337, 338, 339FGH, 340ABC.</u>
----	----------------------------	--------------------------------	--

SECTION B - TEMPORARY ENGINEERING WORKS - continued

At or between	Lines affected	Remarks
<u>LIVERPOOL STREET TO NORWICH - continued</u>		
SUNDAY 28 SEPTEMBER - continued		
91 Church Lane LC and Chelmsford (Country End)	Down Main BLOCKED Up Main BLOCKED	00 01 to 07 00)Track maintenance,)unloading rails, 00 01 to 12 00)bridgework (No. 143A))and overhead line work.)Mechanical equipment in)use. 00 01 to 07 00)Possession to be given)up for passage of 1Y02)02 20 Liverpool Street)to Ipswich over Down)Main line. 07 00 to)12 00 Single line)working over Down Main)line.

92 Manningtree South Jn and East Suffolk Jn	All BLOCKED to electric trains	00 45 to 07 30. In connection with engineering work. <u>Isolation of electrical sections 343 and 344.</u>
93 Ipswich Station and Claydon LC	Down Main BLOCKED	00 45 to 07 30. Unloading materials.
94 East Suffolk Jn and Barham	All BLOCKED	08 00 to 17 00. Loading materials. Crane and mechanical equipment in use. <u>Possession to be given up for passage of trains.</u>

MONDAY/TUESDAY 29/30 SEPTEMBER

94A Tivetshall Jn and Swainsthorpe	Down BLOCKED	23 00 to 04 30. Unloading materials. <u>Single line working over Up line.</u>
--	-----------------	--

MONDAY 29 AND TUESDAY 30 SEPTEMBER

95 Diss and Swainsthorpe	All	07 00 to 18 00 daily. Signalling work (Audley End, Burston, Gissing, Moulton and Newton Flotman LCs).
--------------------------------	-----	---

SECTION B - TEMPORARY ENGINEERING WORKS - continued

At or between	Lines affected	Remarks
---------------	----------------	---------

LIVERPOOL STREET TO NORWICH - continued

MONDAY 29 SEPTEMBER TO WEDNESDAY 1 OCTOBER

96	Chadwell Heath Jn and Gidea Park Station Jn	Down and Up Electric BLOCKED	10 15 to 15 15 daily. Track maintenance. Mechanical equipment in use. <u>Trains to travel over Main lines.</u>
97	Stowmarket Station (Country End) and Claydon LC	Up Main BLOCKED	23 30 Mon and Tue to 05 45 Tue and Wed. Track maintenance. Mechanical equipment in use. <u>Single line working over Down Main line.</u>

MONDAY 29 SEPTEMBER TO FRIDAY 3 OCTOBER

98	Bethnal Green and Stratford (London End)	Down and Up Electric BLOCKED	23 00 Mon to Thu to 05 00 Tue to Fri. Overhead line work. Mechanical equipment in use. <u>Isolation of electrical sections 309A, 310B. Trains to travel over Main lines.</u>
99	Romford Jn and Gidea Park Jn	Down and Up Main BLOCKED	22 10 Mon to Thu to 05 00 Tue to Fri. Track maintenance and undertrack excavation. Mechanical equipment in use. <u>Isolation of electrical sections 327BD, 328BC. Trains to travel over Electric lines.</u>
100	Hatfield Peverel and New Hall G.F.	Up	09 00 to 16 00 daily. Track maintenance. 35m. 27chs. and 35m. 22chs.
101	Swainsthorpe and Norwich Station	All BLOCKED	23 45 Mon to Thu to 05 00 Tue to Fri. Construction work (overhead line) and track maintenance. <u>Possession to be given up for passage of trains.</u>

TUESDAY 30 SEPTEMBER

102	Liverpool Street Station	Platform 10 BLOCKED	10 00 to 15 30. Repairs to station roof. Mechanical equipment in use. <u>Isolation of electrical sections 305H. Trains to be replatformed as necessary.</u>
103	Witham and Kelvedon	Down Main BLOCKED	00 01 to 04 50. Track maintenance. Mechanical equipment in use. <u>Single line working over Up Main line.</u>

SECTION B - TEMPORARY ENGINEERING WORKS - continued

At or between	Lines affected	Remarks
<u>LIVERPOOL STREET TO NORWICH - continued</u>		
TUESDAY/WEDNESDAY 30 SEPTEMBER/1 OCTOBER		
104 Colchester and Ardleigh LC	Down Main BLOCKED	23 30 to 05 30. Track maintenance. Mechanical equipment in use. <u>Single line working over Up Main line.</u>
WEDNESDAY/THURSDAY 1/2 OCTOBER		
105 Halifax Jn and Manningtree North Jn	Up BLOCKED	23 30 to 05 30. Track maintenance. Mechanical equipment in use. <u>Single line working over Down line.</u>
106 East Suffolk Jn and Haughley Jn	All BLOCKED to electric trains	23 30 to 04 25. In connection with engineering work between Barham and Haughley Jn. <u>Isolation of electrical sections 347 and 348.</u>
107 Barham and Haughley Jn	Down Main and Down Goods Loop BLOCKED	23 30 to 04 25. Track maintenance and level crossing road repairs (Regent Street LC). Crane and mechanical equipment in use. <u>Single line working over Up Main line.</u>
THURSDAY 2 OCTOBER		
108 Liverpool Street Station	Platform 10 BLOCKED	10 00 to 15 30. Repairs to station roof. Mechanical equipment in use. <u>Isolation of electrical sections 305H. Trains to be replatformed as necessary.</u>
109 Chadwell Heath Jn and Gidea Park Station Jn	Down and Up Electric BLOCKED	10 15 to 15 15. Track maintenance and unloading rails. Mechanical equipment in use. <u>Isolation of electrical sections 325DE, 326AB. Trains to travel over Main lines.</u>
FRIDAY 3 TO MONDAY 6 OCTOBER		
110 Bethnal Green and Stratford (London End)	Down and Up Electric BLOCKED	23 00 Fri to 05 00 Mon. Track maintenance, track renewal and overhead line work. Mechanical equipment in use. <u>Isolation of electrical sections 309A, 310B. Trains to travel over Main lines.</u>

SECTION B - TEMPORARY ENGINEERING WORKS - continued

At or between	Lines affected	Remarks
---------------	----------------	---------

NAVARINO ROAD JN TO NORTH WOOLWICH

UNTIL FURTHER NOTICE

111	Highbury and Homerton	All	07 30 to 18 00. Earthwork and construction work. Mechanical equipment in use. (86/1)
-----	-----------------------	-----	---

FRIDAY/SATURDAY 26/27 SEPTEMBER

.112	Dalston Western Jn and Hackney Central	All BLOCKED to AC electric trains	23 59 to 05 00. In connection with engineering work between Bethnal Green and Hackney Downs. <u>Isolation of electrical sections 314DEF.</u>
------	--	---	--

SUNDAY 28 SEPTEMBER

113	Navarino Road Jn and Channelsea North Jn	Down and Up BLOCKED	00 01 to 08 00. Construction work (overhead line). Crane and mechanical equipment in use. <u>Isolation of electrical sections 707 and 708.</u>
114	Channelsea North Jn and Stratford Central Jn West	Down and Up	00 01 to 08 00. Construction work (overhead line). <u>Isolation of electrical sections 705C, 706A.</u>
.115	Stratford Low Level and North Woolwich	All BLOCKED	00 15 to 08 00. Track maintenance. 4m. 09chs. and 4m. 19chs. <u>Isolation of electrical sections 701, 702, 703, 704, 705A, 706C.</u>

STRATFORD, LEA JN TO HIGH MEADS JN

SUNDAY 28 SEPTEMBER

116	Lea Jn and High Meads Jn	Down and Up BLOCKED	00 01 to 08 00. Construction work (overhead line). Crane and mechanical equipment in use.
-----	--------------------------	------------------------	---

SECTION B - TEMPORARY ENGINEERING WORKS - continued

At or between	Lines affected	Remarks
---------------	----------------	---------

CHANNELSEA NORTH JN TO TEMPLE MILLS EAST JN

SUNDAY 28 SEPTEMBER

117	Channelsea North Jn and High Meads Jn	Down and Up	08 00 to 16 00. Track maintenance.
-----	---	-------------	------------------------------------

CHANNELSEA SOUTH JN TO STRATFORD CENTRAL JN WEST

UNTIL FURTHER NOTICE

118	Channelsea South Jn and Stratford Central Jn West	Down and Up BLOCKED to electric trains	In connection with engineering work. (86/i4)
-----	---	--	---

SUNDAY 28 SEPTEMBER

119	Channelsea North Jn and Stratford Central Jn West	Down and Up	00 01 to 08 00. Construction work (overhead line). <u>Isolation of electrical sections 705C, 706A.</u>
-----	---	-------------	---

FOREST GATE JN TO WOODGRANGE PARK JN

SUNDAY 28 SEPTEMBER

120	Forest Gate Jn and Barking Station (Country End)	All BLOCKED to electric trains	00 50 to 06 15. In connection with engineering work between Woodgrange Park Jn and Barking Tilbury Line Jn West. <u>Isolation of electrical sections 512 and 513.</u>
-----	---	--------------------------------------	--

ROMFORD TO UPMINSTER

MONDAY 29 SEPTEMBER

121	Romford and Upminster	Single BLOCKED	01 00 to 05 00. Overhead line work. <u>Isolation of electrical sections 327D.</u>
-----	-----------------------------	-------------------	--

SECTION B - TEMPORARY ENGINEERING WORKS - continued

At or between	Lines affected	Remarks	
<u>SHENFIELD JN TO SOUTHEND VICTORIA</u>			
UNTIL FURTHER NOTICE			
122	Billericay	Down and Up	07 30 to 17 30. Construction work and platform work. Mechanical equipment in use. (86/19)
123	Wickford Station	All	Platform work and earthwork. (85/63)
124	Wickford Jn	All	08 00 to 17 00. Signalling work. (85/41)
125	Rayleigh and Hockley	Down	08 00 to 17 00. Earthwork 34½ and 34¾ m.p. Mechanical equipment in use. (85/61)
126	Southend Victoria Station	All	08 00 to 18 00. Repairs to station roof. (86/20)

SATURDAY 27 SEPTEMBER

127	Southend Victoria Station	Platforms 2 and 3 BLOCKED	08 00 to 18 00. Repairs to station roof and painting station. <u>Isolation electrical sections 375A, 376H.</u> <u>Trains to be replatformed as necessary.</u>
-----	---------------------------	------------------------------	--

SATURDAY/SUNDAY 27/28 SEPTEMBER

128	Hockley and Southend Victoria	Down BLOCKED	23 59 to 06 00. Earthwork (Rochford Station). <u>Single line working over Up line.</u>
-----	-------------------------------	-----------------	--

WICKFORD JN TO SOUTHMINSTER

UNTIL FURTHER NOTICE

129	Wickford Jn	All	08 00 to 17 00. Signalling work. (85/41)
130	Fambridge Station	Single	07 30 to 18 00. Platform work. (85/55)
131	Burnham-on-Crouch	Single	07 30 to 18 00. Earthwork. 43m 24chs. (85/30)

SECTION B - TEMPORARY ENGINEERING WORKS - continued

At or between	Lines affected	Remarks
---------------	----------------	---------

WICKFORD JN TO SOUTHMINSTER - continued

FRIDAY/SATURDAY 26/27 SEPTEMBER

132	Wickford Jn and Southminster	Single BLOCKED	23 59 to 04 45. Overhead line work. Mechanical equipment in use. <u>Isolation of electrical sections 377.</u>
-----	------------------------------------	-------------------	---

WITHAM TO BRAINTREE

UNTIL FURTHER NOTICE

133	Witham and Braintree	Single	07 00 to 18 00. Construction work (Bridge No. 2102B). (86/19)
-----	-------------------------	--------	--

SUNDAY 28 SEPTEMBER

134	Witham and Braintree	Single BLOCKED to electric trains	00 05 to 07 00. In connection with engineering work. <u>Isolation of electrical sections 379.</u>
-----	-------------------------	---	---

MONDAY 29 SEPTEMBER TO SATURDAY 4 OCTOBER

135	Witham and Braintree	Single BLOCKED	23 40 Mon to Fri to 05 30 Tue to Sat. Bridgework (No.2102B) and overhead line work. Mechanical equipment in use. <u>Isolation of electrical sections 379.</u>
-----	----------------------------	-------------------	---

COLCHESTER TO CLACTON

UNTIL FURTHER NOTICE

136	Colchester Jn and East Gate Jn	Down Clacton Avoiding	08 00 to 17 00. Earthwork. 52m. 25chs. and 52m. 29chs. Mechanical equipment in use. (85/38)
-----	--------------------------------------	--------------------------	--

SATURDAY/SUNDAY 27/28 SEPTEMBER

137	Colchester Jn and East Gate Jn	Down Clacton Avoiding and Clacton Single/ Down and Up Clacton BLOCKED	23 30 to 07 15. Track maintenance. <u>Possession to be given up for passage of Engineers' trains.</u>
-----	--------------------------------------	--	---

SECTION B - TEMPORARY ENGINEERING WORKS - continued

At or between	Lines affected	Remarks
<u>COLCHESTER TO CLACTON - continued</u>		
SATURDAY/SUNDAY 27/28 SEPTEMBER - continued		
138 Hythe Station and Great Bentley	Down BLOCKED Up BLOCKED	23 30 to 08 00) Trimming lineside vegetation, track renewal, formation renewal and overhead line work. Mechanical equipment in use. <u>08 00 to 16 00 Sun.</u> <u>Possession to be given up for passage of trains.</u>

SUNDAY 28 SEPTEMBER

139 Colchester Jn and Clacton	All BLOCKED to electric trains	00 10 to 07 15. In connection with engineering work between Hythe Station and Great Bentley. <u>Isolation of electrical sections 381, 382, 383, 384, 385 and 386.</u>
-------------------------------	--------------------------------------	---

MONDAY 29 SEPTEMBER TO WEDNESDAY 1 OCTOBER

140 Thorpe-le-Soken and Clacton	Down BLOCKED	23 45 Mon and Tue to 05 15 Tue and Wed. Trimming lineside vegetation and unloading materials. Mechanical equipment in use. <u>Isolation of electrical sections 386BC.</u>
---------------------------------	-----------------	---

TUESDAY 30 SEPTEMBER TO FRIDAY 3 OCTOBER

141 Colchester Jn and Thorpe-le-Soken	Down and Up BLOCKED	23 30 Tue to Thu to 04 45 Wed to Fri. Track maintenance and unloading materials. Mechanical equipment in use. <u>Possession to be given up for passage of Freight trains to/from Hythe.</u>
---------------------------------------	------------------------	---

SECTION B - TEMPORARY ENGINEERING WORKS - continued

At or between	Lines affected	Remarks
---------------	----------------	---------

EAST GATE JN TO ST. BOTOLPHS

SUNDAY 28 SEPTEMBER

142 East Gate Jn and St. Botolphs	All BLOCKED to electric trains	00 10 to 07 15. In connection with engineering work between Hythe Station and Great Bentley. <u>Isolation of electrical sections 381.</u>
-----------------------------------	--------------------------------	---

COLNE JN TO HYTHE JN

SUNDAY 28 SEPTEMBER

143 Colne Jn and Hythe Jn	Down and Up BLOCKED to electric trains	00 10 to 07 15. In connection with engineering work between Hythe Station and Great Bentley. <u>Isolation of electrical sections 381.</u>
---------------------------	--	---

THORPE-LE-SOKEN TO WALTON-ON-NAZE

SUNDAY 28 SEPTEMBER

144 Thorpe-le-Soken and Walton-on-Naze	Single BLOCKED to electric trains	00 10 to 07 15. In connection with engineering work between Hythe Station and Great Bentley. <u>Isolation of electrical sections 387.</u>
--	-----------------------------------	---

WEDNESDAY 1 TO FRIDAY 3 OCTOBER

145 Thorpe-le-Soken and Walton-on-Naze	Single BLOCKED	23 30 Wed and Thu to 05 15 Thu and Fri. Track maintenance and trimming lineside vegetation. Mechanical equipment in use. <u>Isolation of electrical sections 387.</u>
--	----------------	---

MANNINGTREE SOUTH JN TO HARWICH

UNTIL FURTHER NOTICE

146 Wrabness and Mistley	Up	07 30 to 17 00. Earthwork. 64m. 46chs. and 64m. 15chs. Mechanical equipment in use. (85/65)
147 Parkeston West and Harwich Town	Single	07 30 to 18 00. Track maintenance, track renewal and earthwork. 70 $\frac{1}{2}$ m.p. Mechanical equipment in use. (85/27)

SECTION B - TEMPORARY ENGINEERING WORKS - continued

At or between	Lines affected	Remarks
<u>EAST SUFFOLK JN TO OULTON BROAD NORTH JN</u>		
UNTIL FURTHER NOTICE		
148 Melton and Wickham Market	Single	07 00 to 18 00. Bridgework (No. 426). 81m. 11chs. Crane in use. (85/26)

MONDAY 29 SEPTEMBER TO FRIDAY 3 OCTOBER

149 Halesworth and Oulton Broad North Jn	Single	08 00 to 16 00 daily. Track maintenance 100% and 115% m.p. Mechanical equipment in use.
--	--------	--

TUESDAY 30 SEPTEMBER

150 Westerfield	Down	11 00 to 16 30. Signalling work. <u>(See Section 'C')</u> .
-----------------	------	--

WESTERFIELD JN TO FELIXSTOWE

UNTIL FURTHER NOTICE

151 Westerfield Jn and Derby Road	Single	08 00 to 16 00. Earthwork. 73m. 13chs. and 73 $\frac{1}{2}$ m.p. (85/61)
152 Derby Road and Felixstowe Beach Jn	Single	07 30 to 17 00. Earthwork. 82% and 83m.p. Mechanical equipment in use. (86/1)

TUESDAY 30 SEPTEMBER

153 Trimley	All	10 15 to 16 00. Signalling work. <u>(See Section 'C')</u> .
-------------	-----	--

NORWICH TO LOWESTOFT

UNTIL FURTHER NOTICE

154 Norwich Station	All	Track renewal, platform work and earthwork. Crane and mechanical equipment in use. (85/62)
155 Norwich Station and Trowse Lower Jn	All <u>Between Trains</u>	07 00 to 17 00. Construction work (overhead line), earthwork, track maintenance and signalling work. Points and signals disconnected. (86/7)

SECTION B - TEMPORARY ENGINEERING WORKS - continued

At or between	Lines affected	Remarks
NORWICH TO LOWESTOFT - continued		
UNTIL FURTHER NOTICE - continued		
156	Thorpe Jn All	08 00 to 17 00. Earthwork and track maintenance. (85/22)
157	Whitlingham Jn Up and Thorpe Jn	07 30 to 17 00. Earthwork 1½ and 1m.p. Mechanical equipment in use. (86/13)
158	Reedham Swing Bridge Down and Up BLOCKED	08 00 to 16 00. Bridgework (No. 1238). <u>Possession to be given up for passage of trains.</u> (86/23)
159	Oulton Broad North Jn All and Lowestoft	08 00 to 16 00. Undertrack excavation. 23 and 23½m.p. (86/26)

SATURDAY/SUNDAY 27/28 SEPTEMBER

160	Oulton Broad North Jn and Lowestoft	Down and Up BLOCKED	23 59 to 07 00. Unloading materials and earthwork. 23½ and 23m.p. Mechanical equipment in use. <u>Possession to be given up for passage of trains.</u>
-----	---	------------------------	---

SATURDAY/SUNDAY 27/28 AND SUNDAY 28 SEPTEMBER

161	Trowse Swing Bridge and Norwich	Crown Point Depot Nos. 1 and 2 Reception lines BLOCKED 'A'/'E' line BLOCKED 'B' line and 'C' line/ Up Main BLOCKED All	22 00 Sat to 07 00)Track maintenance,)track renewal and)signalling work.)Crane and 22 00 Sat to 16 00)mechanical)equipment in use. 23 15 Sat to 07 00) <u>Possession to be)given up for)passage of trains)over 'B' and 'C' 16 00 to 18 00 Sun)<u>lines. (See)Section 'C'.</u></u>
-----	---------------------------------------	--	---

SECTION B - TEMPORARY ENGINEERING WORKS - continued

At or between	Lines affected	Remarks
---------------	----------------	---------

NORWICH TO LOWESTOFT - continued

MONDAY 29 SEPTEMBER TO FRIDAY 3 OCTOBER

162 Swainsthorpe and Norwich Station	All Lines BLOCKED	23 45 Mon to Thu to 05 00 Tue to Fri. Construction work (overhead line) and track maintenance. <u>Possession to be given up for passage of trains.</u>
--------------------------------------	----------------------	---

WEDNESDAY/THURSDAY 1/2 OCTOBER

163 Thorpe Jn and Whitlingham Jn	Down and Up Lowestoft BLOCKED	23 30 to 05 15. Loading rails. Crane and mechanical equipment in use.
----------------------------------	----------------------------------	---

WHITLINGHAM JN TO CROMER

UNTIL FURTHER NOTICE

164 Whitlingham Jn and Wroxham	Down and Up	07 30 to 16 30. Bridgework (No. 365). 3m. 48chs. (86/6)
165 Cromer Station	Platforms 1 and 2	Platform work. (86/15)

CROMER TO SHERINGHAM

UNTIL FURTHER NOTICE

166 Cromer Station	Platforms 1 and 2	Platform work. (86/15)
--------------------	-------------------	---------------------------

BRUNDALL JN TO YARMOUTH VIA ACLE

UNTIL FURTHER NOTICE

167 Lingwood	Single	08 00 to 17 00. Construction work. 8m. 03chs. (86/12)
168 Acle Station	Down and Up	08 00 to 17 00. Platform work. (86/20)

SECTION B - TEMPORARY ENGINEERING WORKS - continued

At or between	Lines affected	Remarks
<u>BETHNAL GREEN JN TO KING'S LYNN</u>		
UNTIL FURTHER NOTICE		
169 Cambridge Heath Station	Down and Up Suburban	08 00 to 17 00. Platform work. Mechanical equipment in use. <u>(See Section 'D')</u> . (86/24)
170 London Fields Station	Down and Up Suburban	Platform work. Mechanical equipment in use. <u>(See Section 'D')</u> . <u>From 08 00 Saturday 27 September.</u> (86/27)
171 Enfield Lock and Waltham Cross	Down and Up	07 00 to 18 00. Bridgework (No.1418C). 12m. 34chs. Crane and mechanical equipment in use. (85/59)
172 Bishops Stortford (Country end) and Stansted	Down and Up Main BLOCKED to electric trains	Overhead line work. <u>Isolation of electrical sections 427, 428 (buffer section).</u> (85/41)
173 Bishops Stortford and Cambridge (North)	All	07 00 to 18 00. Construction work (overhead line). Mechanical equipment in use. (85/21)
174 Whittlesford Station	Down	Platform work 49m. 02chs. Mechanical equipment in use. (86/21)
175 Shelford	Down and Up	Platform work. 52m. 36chs. Mechanical equipment in use. (86/6)
176 Chesterton Jn and Milton Fen LC	Down and Up	07 30 to 18 00. Bridgework (No. 1550B). 58m. 63chs. Mechanical equipment in use. (86/24)

SECTION B - TEMPORARY ENGINEERING WORKS - continued

At or between	Lines affected	Remarks
---------------	----------------	---------

BETHNAL GREEN JN TO KING'S LYNN - continued

UNTIL FURTHER NOTICE - continued

177 King's Lynn Harbour Jn and King's Lynn Jn	Single	08 00 to 19 00. Earthwork. 95m. 25chs. and 95m. 70chs. Mechanical equipment in use. <u>From 08 00 Monday 29 September.</u> (86/27)
---	--------	--

FRIDAY/SATURDAY 26/27 SEPTEMBER

178 Bethnal Green (Country End) and Hackney Downs	Down and Up Suburban BLOCKED	21 00 to 05 00. Platform work (London Fields Station) and overhead line work. Mechanical equipment in use. <u>Trains to travel over Fast lines.</u> <u>23 59 to 05 00 Isolation of electrical sections 313A, 314B.</u>
---	---------------------------------	--

SATURDAY 27 SEPTEMBER

179 Harlow Mill and Spelbrook	Down and Up	08 00 to 17 00. Signalling work. (Sawbridgeworth LC).
180 Whittlesford Crossovers and Great Chesterford	Up Main	08 00 to 18 00. Signalling work.

SATURDAY/SUNDAY 27/28 SEPTEMBER

181 Bishops Stortford and Elsenham	Up Main BLOCKED Down Main BLOCKED	22 30 to 08 15) Construction work) (overhead line) 23 45 to 09 00) and loading materials.) 30% and 35% m.p.) Mechanical equipment in use. <u>Possession to be given up for passage of</u>) <u>1P04 02 10 Liverpool</u>) <u>Street to Yarmouth and</u>) <u>1H02 03 10 Liverpool</u>) <u>Street to King's Lynn</u>) <u>over Down Main line.</u>
------------------------------------	--	--

SECTION B - TEMPORARY ENGINEERING WORKS - continued

At or between	Lines affected	Remarks
---------------	----------------	---------

BETHNAL GREEN JN TO KING'S LYNN - continued

SATURDAY/SUNDAY 27/28 SEPTEMBER - continued

182	Elsenham and Great Chesterford	Up BLOCKED Down BLOCKED	22 25 to 08 15) 23 50 to 09 00)	Construction work (overhead line), bridgework (No.1521) and trimming lineside vegetation. 35% and 45% <u>m.p.</u> Mechanical equipment in use. <u>Possession to be given up for passage of 1P04 02 10 Liverpool Street to Yarmouth and 1H02 03 10 Liverpool Street to King's Lynn over Down line.</u>
-----	--------------------------------	----------------------------------	------------------------------------	--

SATURDAY/SUNDAY 27/28 AND SUNDAY 28 SEPTEMBER

183	Harlow Town and Spelbrook	Up BLOCKED Down BLOCKED	23 00 Sat to 06 45) 00 30 to 07 00 Sun)	Drainage. 24% <u>m.p.</u> Mechanical equipment in use. <u>Possession to be given up for passage of 1P04 02 10 Liverpool Street to Yarmouth and 1H02 03 10 Liverpool Street to King's Lynn over Down line.</u>
-----	---------------------------	----------------------------------	--	--

SATURDAY 27 AND SUNDAY 28 SEPTEMBER

184	Cheshunt Jn and Bishops Stortford	All	06 00 to 17 00 daily.	Signalling work.
-----	-----------------------------------	-----	-----------------------	------------------

SUNDAY 28 SEPTEMBER

185	Tottenham South Jn and Cheshunt Jn	Down and Up Main BLOCKED	00 01 to 08 30.	Track maintenance and loading materials. Mechanical equipment in use. <u>Trains diverted via Southbury.</u>
-----	------------------------------------	-----------------------------	-----------------	---

SECTION B - TEMPORARY ENGINEERING WORKS - continued

At or between	Lines affected	Remarks
---------------	----------------	---------

BETHNAL GREEN JN TO KING'S LYNN - continued

SUNDAY 28 SEPTEMBER - continued

186	Cheshunt Station and Broxbourne	Down Main BLOCKED Up Main BLOCKED	00 10 to 08 15)Track maintenance,)track renewal, 00 10 to 18 00)reballasting, unloading)materials and overhead)line work. Mechanical)equipment in use.)00 10 to 08 15) <u>Isolation of electrical</u>) <u>sections 413G, 414C.</u>) <u>Possession to be given</u>) <u>up for passage of 1P04</u>) <u>02 10 Liverpool Street</u>) <u>to Yarmouth, 1H02 03 10</u>) <u>Liverpool Street to</u>) <u>King's Lynn and 1H04</u>) <u>04 00 Liverpool Street</u>) <u>to Harlow Town over</u>) <u>Down Main line.</u>) <u>08 15 to 18 00 Sun.</u>) <u>Isolation of electrical</u>) <u>sections 413G. Single</u>) <u>line working over Down</u>) <u>Main line.</u>
187	Broxbourne Jn and Bishops Stortford (Country End)	All BLOCKED to electric trains	00 35 to 06 20. In connection with engineering work. <u>Isolation of electrical sections 415, 416, 417 and 418.</u>
188	Great Chesterford and Whittlesford Crossovers	Down Main	08 00 to 18 00. Signalling work.
189	Shepreth Branch Jn and Coldham Lane Jn	All BLOCKED	00 30 to 08 00. Construction work (overhead line). 53½ and 56¼m.p. Mechanical equipment in use. <u>Possession to be given up for passage of trains.</u>

SUNDAY 28 SEPTEMBER TO WEDNESDAY 1 OCTOBER

190	Waterbeach and Ely Dock Jn	Down BLOCKED	22 30 Sun to Tue 05 30 Mon to Wed. Track maintenance 66 and 67¼m.p. Mechanical equipment in use. <u>Single line working over Up line.</u>
-----	----------------------------	-----------------	---

SECTION B - TEMPORARY ENGINEERING WORKS - continued

At or between	Lines affected	Remarks
---------------	----------------	---------

BETHNAL GREEN JN TO KING'S LYNN - continued

MONDAY 29 SEPTEMBER

191 Clapton Jn and Broxbourne Jn (Country End)	All BLOCKED to electric trains	01 00 to 03 55. In connection with overhead line work between Brimsdown and Cheshunt Station. <u>Isolation of electrical sections 411, 412, 413 and 414.</u>
192 Brimsdown and Cheshunt Station	Down and Up Main BLOCKED	01 00 to 03 55. Overhead line work. <u>Possession to be given up for passage of Diesel trains.</u>

MONDAY 29 SEPTEMBER TO FRIDAY 3 OCTOBER

193 Elsenham and Audley End	Down BLOCKED	09 25 to 15 00 daily. Construction work (overhead line). 35% and 41m.p. <u>Single line working over Up line.</u>
194 Cambridge (South) and Coldham Lane Jn	All <u>Between Trains</u>	08 00 to 16 00 daily. Construction work (overhead line). 55% and 56% m.p. Mechanical equipment in use.

TUESDAY 30 SEPTEMBER AND WEDNESDAY 1 OCTOBER

195 Broxbourne and Cheshunt Station	Up Main BLOCKED	00 01 to 04 15 daily. Track maintenance and unloading materials. Mechanical equipment in use. <u>Single line working over Down Main line.</u>
-------------------------------------	--------------------	---

TUESDAY 30 SEPTEMBER TO FRIDAY 3 OCTOBER

196 Bethnal Green and Clapton Jn	Down and Up Fast/ Down and Up BLOCKED to electric trains	00 45 to 04 45 daily. In connection with overhead line work between Hackney Downs North Jn and Clapton Jn. <u>Isolation of electrical sections 407 and 408. Electric trains to travel over Suburban lines and to be diverted via Southbury.</u>
197 Hackney Downs North Jn and Clapton Jn	Down and Up BLOCKED	00 45 to 04 45 daily. Overhead line work. Mechanical equipment in use. <u>Trains diverted via Southbury.</u>

SECTION B - TEMPORARY ENGINEERING WORKS - continued

At or between	Lines affected	Remarks
---------------	----------------	---------

BETHNAL GREEN JN TO KING'S LYNN - continued

WEDNESDAY 1 TO FRIDAY 3 OCTOBER

198 Stansted and Elsenham	Down BLOCKED	22 30 Wed and Thu to 05 40 Thu and Fri. Track maintenance. 34 and 34 $\frac{1}{2}$ m.p. Mechanical equipment in use. <u>Single line working over Up line.</u>
------------------------------	-----------------	--

WEDNESDAY 1 TO SATURDAY 4 OCTOBER

199 Cheshunt Station and Brimsdown	Up Main BLOCKED	23 30 Wed to Fri to 05 30 Thu to Sat. Track maintenance and unloading materials. Mechanical equipment in use. <u>Single line working over Down Main line.</u>
--	--------------------	--

READING LANE JN TO NAVARINO ROAD JN (GRAHAM ROAD CURVE)

FRIDAY/SATURDAY 26/27 SEPTEMBER

200 Reading Lane Jn and Navarino Road Jn	Single BLOCKED to electric trains	23 59 to 05 00. In connection with engineering work between Bethnal Green and Hackney Downs. <u>Isolation of electrical sections 314C.</u>
--	---	---

BURY STREET JN TO CHESHUNT

SATURDAY 27 AND SUNDAY 28 SEPTEMBER

201 Bury Street Jn and Cheshunt Jn	Down and Up	06 00 to 17 00 daily. Signalling work.
--	-------------	---

CLAPTON JN TO CHINGFORD

SUNDAY 28 SEPTEMBER

202 Chingford	All	08 00 to 17 00. Signalling work.
---------------	-----	----------------------------------

SECTION B - TEMPORARY ENGINEERING WORKS - continued

At or between	Lines affected	Remarks
---------------	----------------	---------

CLAPTON JN TO CHINGFORD - continued

TUESDAY 30 SEPTEMBER TO FRIDAY 3 OCTOBER

203	Clapton Jn and Chingford	Down and Up BLOCKED	00 55 to 04 50 daily. Track maintenance and unloading materials. Mechanical equipment in use.
-----	--------------------------------	------------------------	---

BROXBOURNE JN TO HERTFORD EAST

UNTIL FURTHER NOTICE

204	Rye House and St. Margarets	Down and Up	08 00 to 18 00. Bridgework (No. 2035A). 19m. 66chs. Mechanical equipment in use. (85/60)
-----	--------------------------------	-------------	---

SUNDAY 28 SEPTEMBER

205	Broxbourne Jn and Hertford East	All BLOCKED	00 30 to 06 30. Track maintenance. Crane in use. <u>Isolation of electrical sections 434 and 435.</u>
-----	---------------------------------------	----------------	--

MONDAY 29 SEPTEMBER

206	Broxbourne Jn and St. Margarets	Down and Up BLOCKED to electric trains	01 00 to 03 55. In connection with overhead line work between Brimsdown and Cheshunt Station. <u>Isolation of electrical sections 414.</u>
-----	---------------------------------------	--	---

COLDHAM LANE JN TO HAUGHLEY JN

UNTIL FURTHER NOTICE

207	Bury St. Edmunds Station	Down	08 00 to 15 00. Repairs to platform awnings. (86/18)
208	Bury St. Edmunds and Elmswell	Down and Up	08 00 to 18 00. Drainage 29m. 78chs. Mechanical equipment in use. (86/12)

SECTION B - TEMPORARY ENGINEERING WORKS - continued

At or between	Lines affected	Remarks
<u>COLDHAM LANE JN TO HAUGHLEY JN - continued</u>		
SATURDAY/SUNDAY 27/28 SEPTEMBER		
209 Bury St. Edmunds and Haughley Jn	Up BLOCKED Down BLOCKED	23 15 to 07 00) Drainage, demolition work, track 23 15 to 16 00) maintenance, track renewal and formation renewal. Crane and mechanical equipment in use. <u>07 00 to</u> <u>16 00 Sun Single line</u> <u>working over Up line.</u>

TUESDAY/WEDNESDAY 30 SEPTEMBER/1 OCTOBER

210 Bury St. Edmunds	Down and Up BLOCKED	23 00 to 05 30. Track maintenance. Mechanical equipment in use. <u>Possession to be given up for passage</u> <u>of trains.</u>
-------------------------	------------------------	---

THURSDAY/FRIDAY 2/3 OCTOBER

211 Elmswell and Haughley Jn	Down BLOCKED	23 00 to 05 30. Track maintenance. Mechanical equipment in use. <u>Single</u> <u>line working over Up line.</u>
---------------------------------	-----------------	---

CHIPPENHAM JN TO ELY DOCK JN

: UNTIL FURTHER NOTICE

212 Soham and Chippenham Jn	Up <u>Between Trains</u>	07 00 to 19 00. Earthwork and track renewal 3m.p. Mechanical equipment in use. (86/22)
--------------------------------	-----------------------------	---

ELY NORTH JN TO TROWSE LOWER JN

UNTIL FURTHER NOTICE

213 Thetford and Lakenheath	Up	08 00 to 16 00. Track maintenance. 87% and 85% m.p. (86/24)
--------------------------------	----	---

SECTION B - TEMPORARY ENGINEERING WORKS - continued

At or between	Lines affected	Remarks
<u>ELY NORTH JN TO TROWSE LOWER JN - continued</u>		
UNTIL FURTHER NOTICE - continued		
214 Wymondham and Hethersett	Down and Up <u>Between Trains</u>	07 30 to 18 00. Bridgework, earthwork and construction work. 115m. 65chs. and 117m. 69chs. Cranes and mechanical equipment in use. (86/18)
215 Wymondham and Trowse Lower Jn	Down and Up	07 30 to 16 00. Signalling work. (85/24)
216 Hethersett and Trowse Lower Jn	Down and Up	07 30 to 16 00. Bridgework (Nos.1638, 1640, 1640A and 349). 121m. 17chs. and 122m. 32chs. (86/22)

MONDAY 29 SEPTEMBER TO FRIDAY 3 OCTOBER

217 Wymondham and Trowse Lower Jn	Down and Up BLOCKED	23 00 Mon to Thu to 05 30 Tue to Fri. Construction work (overhead line) and track maintenance.
-----------------------------------	------------------------	--

THURSDAY 2 OCTOBER

218 Lakenheath and Brandon	Down and Up	09 00 to 15 00. Work on overhead power cables (EEB). 84½m.p. and 84m. 50chs.
----------------------------	-------------	--

WYMONDHAM TO NORTH ELMHAM

UNTIL FURTHER NOTICE

219 Wymondham and North Elmham	Single	08 00 to 16 00. Trimming lineside vegetation. X and 6m.p. Mechanical equipment in use. (85/31)
--------------------------------	--------	---

FENCHURCH STREET TO SHOEBURYNESS

UNTIL FURTHER NOTICE

220 Fenchurch Street Station	All	Construction/demolition work. Mechanical equipment in use. (84/38)
------------------------------	-----	---

SECTION B - TEMPORARY ENGINEERING WORKS - continued

At or between	Lines affected	Remarks
---------------	----------------	---------

FENCHURCH STREET TO SHOEBURYNESS - continued

UNTIL FURTHER NOTICE - continued

221	Fenchurch Street and Stepney East	All	Construction work, and in connection with engineering work (Docklands Light Railway). Mechanical equipment in use. (<u>See Section 'D'</u>). (86/25)
222	Fenchurch Street and Gas Factory Jn	All	08 00 to 17 00. Signalling work. (86/1)
223	East Ham	Down and Up	Construction work. Mechanical equipment in use. (83/51)
224	East Ham and Barking (London End)	Down and Up	Erecting scaffolding in connection with bridge No. 66B. (85/8)
225	Leigh-on-Sea and Benfleet	Up	Sea wall work. (85/34)
226	Leigh-on-Sea	Down	09 00 to 16 00. Demolition work. Mechanical equipment in use. (85/60)
227	Westcliff-on-Sea	Down	09 00 to 16 00. Demolition work. Mechanical equipment in use. (85/60)

*FRIDAY/SATURDAY 26/27 SEPTEMBER

228	Fenchurch Street	All BLOCKED	21 15 to 06 00. Construction work. Mechanical equipment in use.
229	Fenchurch Street and Gas Factory Jn	All BLOCKED	21 15 to 06 00. Repairs to platform awnings (Stepney East Station), construction work and painting Stepney East Station. <u>Isolation of electrical sections 501, 502, 503 and 504.</u>

230 Not used.

SECTION B - TEMPORARY ENGINEERING WORKS - continued

<u>At or between</u>	<u>Lines affected</u>	<u>Remarks</u>
----------------------	-----------------------	----------------

FENCHURCH STREET TO SHOEBURYNESS - continued

SATURDAY 27 SEPTEMBER

231 Benfleet Station	Down and Up	00 50 to 04 20. Painting Benfleet station.
----------------------	-------------	--

SATURDAY/SUNDAY 27/28 SEPTEMBER

232 Christian Street Jn and East Ham (Country End)	All BLOCKED	21 15 to 18 00. Overhead line work and in connection with engineering work at East Ham EMU Depot. Mechanical equipment in use. <u>Isolation of electrical sections 501, 502, 503, 504, 505, 506, 507 and 508. Trains diverted to/from Liverpool Street via Stratford and Forest Gate Jn.</u>
--	----------------	--

SATURDAY 27 TO MONDAY 29 SEPTEMBER

233 Fenchurch Street and Christian Street Jn.	Down and Up Slow BLOCKED	21 15 Sat to 04 00 Mon. Bridgework (Nos. 81 and 82). Om. 45chs. <u>Trains to travel over Fast lines.</u>
---	--------------------------------	--

SUNDAY 28 SEPTEMBER

234 Forest Gate Jn and Barking Station (Country End)	All BLOCKED to electric trains	00 50 to 06 15. In connection with engineering work between Woodgrange Park Jn and Barking Tilbury Line Jn West. <u>Isolation of electrical sections 512 and 513.</u>
235 Barking and Laindon	Down Main BLOCKED to electric trains	01 10 to 07 10. In connection with engineering work at Upminster. <u>Isolation of electrical sections 514B.</u>
236 Upminster and Barking	Up Main BLOCKED	00 01 to 06 00. Track maintenance. 10m. 50chs. and 10m. 30chs.
237 Upminster Station	Platform 2 (Down Main) BLOCKED	01 10 to 07 10. Painting Upminster Station.

SECTION B - TEMPORARY ENGINEERING WORKS - continued

At or between	Lines affected	Remarks
<u>FENCHURCH STREET TO SHOEBURYNESS - continued</u>		
MONDAY 29 SEPTEMBER		
238 Upminster and Pitsea	Down and Up BLOCKED	01 15 to 04 25. Overhead line work. <u>Isolation of electrical sections 519, 520, 521E, 522A. Trains diverted via Grays.</u>
MONDAY 29 SEPTEMBER TO WEDNESDAY 1 OCTOBER		
239 Pitsea and Upminster	Up BLOCKED	23 45 Mon and Tue to 04 35 Tue and Wed. Track maintenance. Mechanical equipment in use. <u>Trains diverted via Grays.</u>
MONDAY 29 SEPTEMBER TO FRIDAY 3 OCTOBER		
240 East Ham (London End) and Barking Station (Country End)	Down and Up Main BLOCKED	21 15 Mon to Thu to 05 15 Tue to Fri. Bridgework (No. 66B) and overhead line work (conversion). Crane and mechanical equipment in use. <u>Isolation of electrical sections 510ABC, 511CDE.</u>
MONDAY 29 SEPTEMBER TO SATURDAY 4 OCTOBER		
241 Fenchurch Street	All BLOCKED	21 15 Mon to Fri to 06 00 Tue to Sat. Construction work. Mechanical equipment in use.
242 Fenchurch Street and Gas Factory Jn.	All BLOCKED	21 15 Mon to Fri to 06 00 Tue to Sat. Repairs to platform awnings (Stepney East Station), construction work and painting Stepney East Station. <u>Isolation of electrical sections 501, 502, 503 and 504.</u>
TUESDAY 30 SEPTEMBER		
243 Fenchurch Street Station	Platforms 2 and 3 BLOCKED	10 25 to 15 45. Construction work. Mechanical equipment in use. <u>Isolation of electrical sections 501D, 504A. Trains to be replatformed as necessary.</u>

SECTION B - TEMPORARY ENGINEERING WORKS - continued

At or between	Lines affected	Remarks
---------------	----------------	---------

FENCHURCH STREET TO SHOE BURYNNESS - continued

WEDNESDAY 1 OCTOBER

244 Fenchurch Street Station	Platforms 1 and 4 BLOCKED	10 25 to 15 45. Construction work. Mechanical equipment in use. <u>Isolation of electrical section 502A, 503B. Trains to be replatformed as necessary.</u>
------------------------------	------------------------------	--

FRIDAY/SATURDAY 3/4 OCTOBER

245 East Ham (London End) and Barking Station (London End)	Down and Up BLOCKED	21 15 to 05 15. Overhead line work and bridgework (No. 66B). Crane and mechanical equipment in use. <u>Isolation of electrical sections 510A, 511E.</u>
--	------------------------	---

GAS FACTORY JN TO BOW JN

SATURDAY/SUNDAY 27/28 SEPTEMBER

246 Gas Factory Jn and Bow Jn	Single BLOCKED	21 15 to 18 00. Overhead line work. Crane and mechanical equipment in use. <u>Isolation of electrical sections 506.</u>
-------------------------------	-------------------	---

UPPER HOLLOWAY TO BARKING, TILBURY LINE JN WEST

UNTIL FURTHER NOTICE

247 Upper Holloway and Crouch Hill Station	Down and Up	Earthwork. 3m 41chs. and 3m 43chs. Mechanical equipment in use. (85/64)
248 Wanstead Park Station	Up	08 00 to 16 00. Platform work. <u>(See Section 'D').</u> (85/50)
249 Woodgrange Park and Barking Station Jn	Down and Up <u>Between Trains</u>	07 30 to 18 00. Bridgework (No. 6). 12m. 26chs. Crane and mechanical equipment in use. (85/62)
250 Woodgrange Park and Barking Tilbury Line Jn West	Down and Up	Erecting scaffolding in connection with bridge No. 14A. (85/8)

SECTION B - TEMPORARY ENGINEERING WORKS - continued

At or between	Lines affected	Remarks
---------------	----------------	---------

UPPER HOLLOWAY TO BARKING, TILBURY LINE JN WEST - continued

SATURDAY/SUNDAY 27/28 SEPTEMBER

251	South Tottenham East Jn and Woodgrange Park Jn	Down and Up BLOCKED	23 30 to 08 00. Track maintenance. Mechanical equipment in use.
-----	--	------------------------	---

SUNDAY 28 SEPTEMBER

252	Forest Gate Jn and Barking Station (Country End)	All BLOCKED to electric trains	00 50 to 06 15. In connection with engineering work between Woodgrange Park Jn and Barking Tilbury Line Jn West. <u>Isolation of electrical sections 512 and 513.</u>
253	Woodgrange Park Jn and Barking Tilbury Line Jn West	Down and Up BLOCKED	00 50 to 06 15. Bridgework (No. 14A). Crane and mechanical equipment in use. <u>Possession to be given up for passage of Engineers' trains.</u>

BARKING, TILBURY LINE JN EAST TO TILBURY RIVERSIDE

UNTIL FURTHER NOTICE

254	Dagenham Dock Station	Down and Up	08 00 to 17 00. Construction work. Mechanical equipment in use. (85/14)
255	Rainham Station	Down and Up	08 00 to 17 00. Construction work. Mechanical equipment in use. (85/14)
256	Purfleet Station	Down and Up	09 00 to 16 00. Platform work. Mechanical equipment in use. (85/61)

SECTION B - TEMPORARY ENGINEERING WORKS - continued

At or between	Lines affected	Remarks
---------------	----------------	---------

BARKING, TILBURY LINE JN EAST TO TILBURY RIVERSIDE - continued

SUNDAY 28 SEPTEMBER

257	Barking Tilbury Line Jn East and West Thurrock Jn.	Down and Up Main BLOCKED	00 35 to 22 00. Track maintenance, formation renewal, undertrack excavation and overhead line work. Crane and mechanical equipment in use. <u>Isolation of electrical sections 530, 531, 532AB, 533DE. 0M52 21 00 Ripple Lane to Tilbury RCT to travel over Up Goods line and to be diverted via Barking and Upminster. Other trains diverted via Upminster.</u>
-----	--	-----------------------------	--

MONDAY 29 SEPTEMBER TO WEDNESDAY 1 OCTOBER

258	Purfleet and West Thurrock Jn	Down BLOCKED	23 35 Mon and Tue to 04 30 Tue and Wed. Unloading materials. <u>Single line working over Up line.</u>
-----	-------------------------------	-----------------	---

TILBURY RIVERSIDE TO PITSEA

SUNDAY 28 TO MONDAY 29 SEPTEMBER

259	Thames Haven Jn and Pitsea	All BLOCKED	01 10 Sun to 02 30 Mon. Track maintenance, level crossing work (Fobbing and Pitsea Hall LCs) and overhead line work. Mechanical equipment in use. <u>Isolation of electrical sections 536 and 537. (See Section 'C').</u>
-----	----------------------------	----------------	---

WEDNESDAY 1 TO FRIDAY 3 OCTOBER

260	Thames Haven Jn and Pitsea	Up BLOCKED Down BLOCKED	23 30 Wed and Thu)Track to 05 00 Thu and Fri) maintenance. 01 00 to 05 15)Mechanical Thu and Fri)equipment in use.
-----	----------------------------	----------------------------------	--

SECTION CSIGNALLING AND PERMANENT WAY ALTERATIONS

- * * Items marked thus will not appear in future issues and a note must be
 * taken of them by all concerned.

DETAILS OF WORK REFERRED TO IN SECTION BSUNDAY 28 SEPTEMBER - TIVETSHALL

The trailing crossover will be secured out of use pending removal and the associated shunting signals will be abolished.

(30)

SUNDAY 28 SEPTEMBER - TROWSE SWING BRIDGE

The following points will be secured out of use pending removal :-

Trailing Crossover between the Down and Up Main Lines.

Facing connection - Down Main to the Temporary Goods Single Line to Crown Point and Whitlingham Junction (Reinstated Wensum Curve Single Line).

All associated ground shunting signals will be abolished.

The temporary Goods Single Line will be taken out of use and revert to being the Crown Point Depot "Dead End" Siding No.1A. A temporary Stop-Block will be provided adjacent to the site of the former permanent red colour light signal TSB3 which will also be abolished.

(30)

SUNDAY 28 SEPTEMBER - THORPE JUNCTION

A new Engine Neck Siding will be brought into use adjacent to and connected to Line 'A/E' via new points giving access at the Norwich Station end.

The new Siding line is located between Carrow Road Bridge and the Up/Down Lowestoft Line Crossovers, and provides standage for stabling up to the equivalent of two main line locomotives (approximately 50 yards standage).

A new "Exit" position light shunting signal plated NO 1779 will be provided at the trap points of the new Engine Neck Siding and a 2-way stencil-type route indicator will be provided. A telephone communicating with Norwich Station signal box will be provided adjacent to NO 1779 signal.

SECTION C - SIGNALLING AND PERMANENT WAY ALTERATIONS - continuedDETAILS OF WORK REFERRED TO IN SECTION B - continuedSUNDAY 28 SEPTEMBER - THORPE JUNCTION - continuedAdditional routes on existing signals

The existing signals now applying towards the new Engine Neck Siding and the route indications on new NO 1779 Signal are included in the Description of Signals below.

Main Signals

<u>Line</u>	<u>Signal</u>	<u>Aspect</u> (PL = Position Light)	<u>Route</u> <u>Indication</u>	<u>Application</u> <u>Towards</u>
Platforms 1, 2, 3, 4, 5, 6	NO 574/576 578/580/584 586	PL	'N'	Engine Neck Sidings.
Jubilee Siding	NO 588	PL	'N'	"

Position Light Signals

Middle Siding	NO 1792		'N'	"
Engine Neck Siding	NO 1779		'C'	Line C, Signal No. 1785.
			'E'	Line E Signal No. 1787. (30)

SUNDAY 28 SEPTEMBER - CAMBRIDGE - COLDHAM LANE DEPOT CARRIAGE SIDINGS

New trap points will be brought into use at the North end of No. 4 Carriage Siding at 56 $\frac{1}{2}$ mp in Coldham Lane Depot.

The new trap points and the adjacent spring points connecting No.4 Carriage Siding to Nos. 4 and 5 Diesel Sidings will be operated from a new single-lever ground frame, the normal position of which will set the former spring points in Nos. 4 and 5 Diesel Sidings towards Coldham Lane Depot exit line Position Light Signal No.740 and the new trap points in the open trap position.

The ground frame lever will be maintained locked in the normal position by a padlock, the key to which will be held by the Carriage Sidings/Yard Supervisor. Telephone communication will be provided between the new ground frame and Cambridge Signalbox.

SECTION C - SIGNALLING AND PERMANENT WAY ALTERATIONS - continuedDETAILS OF WORK REFERRED TO IN SECTION B - continuedSUNDAY 28 SEPTEMBER - CAMBRIDGE - COLDHAM LANE DEPOT CARRIAGE SIDINGS - continued

The "STOP TELEPHONE" notice board at the North end of No.4 Carriage Siding and the associated telephone will be abolished. A new notice board worded "STOP FOR ORDERS" will be provided immediately South of the new trap points in No.4 Carriage Siding.

(30)

• SUNDAY 28 SEPTEMBER - FOBHING LEVEL CROSSING 30m 34chs (between Stanford-le-Hope and Pitsea)

• The crossing will be converted to automatic half-barriers. Fobbing Gate Box will be abolished.

Telecommunication will be provided between the crossing and Pitsea Signalbox.

Alterations to signalling ('PJ' denotes prefix of Pitsea Signalbox)

Down Tilbury

Semi-automatic signal F3 (level crossing protecting signal) and its associated A.W.S. equipment will be abolished.

PJ22 automatic signal (on the approach to F3) will now display Red or Green aspect only.

Up Tilbury

Level crossing protecting signal F2 will now display Yellow or Green aspect only and function as Up Distant. This signal will be replated PJ27R. (The semi-auto plate will be removed).

• Signal PJ23 (on the approach side of PJ27R signal, former F2) will now display Red or Green aspect only.

(30)

• TUESDAY 30 SEPTEMBER - WESTERFIELD

The notice board at the Lowestoft end of the Down Platform worded, "STOP - OBTAIN TOKEN AND PERMISSION TO PROCEED", will be repositioned 15 yards nearer to the signal box.

(30)

TUESDAY 30 SEPTEMBER - TRIMLEY

The Up Passenger Platform Loop will be taken out of use and the Down Platform line will become the Single Line (Up/Down Platform).

The points at each end of the Loop will be secured out of use in the normal position for through running along the Single line. (The points at the Felixstowe end of the Loop will be secured out of use pending removal).

SECTION C - SIGNALLING AND PERMANENT WAY ALTERATIONS - continued

DETAILS OF WORK REFERRED TO IN SECTION B - continued

TUESDAY 30 SEPTEMBER - TRIMLEY - continued

Signalling Alterations

The Up Platform Loop Starting Signal will now be applicable to the Single line.

The Up Single line Home Signal will apply along the Single line towards the Up/Down Platform.

(30)

DETAILS OF WORK ALREADY CARRIED OUT

NEW HALL

The Up Loop has been taken out of use Until Further Notice.

(UFN)

HATFIELD PEVEREL

The facing and trailing crossovers are out of use until further notice.

(UFN)

GISSING LEVEL CROSSING AT 98m 57chs (between Diss and Tivetshall

The level crossing gates have been removed and the crossing converted to one with automatic half-barriers.

Telephone communication has been provided between the crossing and Diss signalbox (previously to Tivetshall).

Working in wrong direction

The barriers have been equipped to work automatically when approached in the reverse direction and for this purpose a combined St. Andrew's Cross/50 m.p.h. speed restriction sign has been provided 954 yards from the crossing applicable to each rail approach in the wrong direction.

(29)

NEWTON FLOTMAN LEVEL CROSSING AT 108m. 19chs. (between Tivetshall and Swainsthorpe)

The level crossing gates have been removed and the crossing converted to one with Automatic half-barriers.

The crossing will be closed to road traffic and the barriers secured in the lowered position until the associated road works are completed when the barriers will be fully commissioned.

Telephone communication has been provided between the level crossing and Swainsthorpe signalbox.

SECTION C - SIGNALLING AND PERMANENT WAY ALTERATIONS - continuedDETAILS OF WORK ALREADY CARRIED OUT - continuedNEWTON FLOTMAN LEVEL CROSSING AT 108m. 19chs. (between Tivetshall and Swainsthorpe) - continuedWorking in wrong direction

The automatic half-barriers have been equipped to work automatically when approached in the wrong direction, and for this purpose a combined St. Andrews Cross/50 m.p.h. speed restriction sign has been provided 1,003 yards from the crossing applicable to each rail approach in the wrong direction. (29)

TROWSE UPPER JUNCTION AND TROWSE LOWER JUNCTIONTrowse Upper Junction

Trowse Upper Junction Signal Box, together with all signals worked therefrom has been abolished. All points previously worked therefrom including the Siding line to Victoria Goods Depot have been secured out of use pending removal.

(The catch points are unaffected at this stage).

The Block Section is now between Swainsthorpe and Trowse Lower Junction.

Trowse Lower JunctionSignalling Alterations

A new Trowse Lower Junction Down Main Distant plated TL47 (3-aspect colour light signal exhibiting Yellow or Green aspect only at this stage) has been provided 1,500 yards before reaching the Trowse Lower Junction Down Home signal TL45. (This new Distant signal is 700 yards further from TL45 signal than was the former Trowse Upper Junction Down Main Starting signal TU20 which incorporated the Trowse Lower Junction Down Distant).

An Automatic Warning System track inductor has been provided in conjunction with TL47 new colour light Distant signal. (29)

THORPE JUNCTION

Line 'A'/'E' has been realigned nearer to Line 'B', between Carrow Road Bridge and the Up/Down Lowestoft lines crossovers at Thorpe Junction. The associated redundant trap points and sand-drag have been removed. (29)

SECTION C - SIGNALLING AND PERMANENT WAY ALTERATIONS - continuedDETAILS OF WORK ALREADY CARRIED OUT - continued** THORPE JUNCTION

*

The lines leading into Line 'C' (Up Main) at Thorpe Junction have been remodelled resulting in Line 'B' (Up Lowestoft) and Nos. 1 and 2 Receptions being realigned.

The Headshunt associated with Nos. 1 and 2 Reception lines has been abolished.

(27)

** THORPE JUNCTION AND NORWICH STATION



*

An elevated double-sided "OFF" indicator plated NO 1785/1787R has been provided on the left-hand side of line 'A'/'E', 80 yards on the Whittingham Junction side of Carrow Road Bridge.

The indication 'OFF' will be illuminated when either position light signal NO 1785 (Line 'C') or NO 1787 (Line 'E') has been cleared.

(27)

UFFORD LEVEL CROSSING AT 81M. 60CHS. (East Suffolk Line)

The combined St. Andrews Cross/speed restrictions sign  on the Up approach to Ufford level crossing has been replaced by an  sign 476 yards before reaching the crossing.

(29)

SNAILWELL (Between Chippenham Junction and Soham)

A new trailing connection has been brought into use in the Up line at 3m.p. leading to Firmin Coates Private Siding.

Operation is by two-lever groundframe released from Chippenham Junction signalbox. (Telephone communication has been provided between the ground frame and signalbox).

(28)

SECTION D

GENERAL INSTRUCTIONS AND NOTICES

A thick vertical line denotes new or amended items.

** Items marked thus will not appear in future issues and a note must be taken of them by all concerned.

*

EASTERN REGION SECTIONAL APPENDIX (SOUTHERN AREA)

TABLE A : DETAILS OF RUNNING LINES

Running Lines and Signalling System	Location	M. Ch.	Permanent Speed Restrictions		Remarks
			Down m.p.h.	Up	
<u>LIVERPOOL STREET TO NORWICH</u>					
<u>Page 60</u>					
<u>Delete:-</u>	Ardley End LC	97 00			
<u>Substitute :-</u>	Audley End (Norfolk) LC (AHB-X)	97 05	<u>X50</u>	<u>X50</u>	<u>Approaching level crossing in wrong direction.</u> (10.SD)
<u>Amend :-</u>	Gissing LC (AHB-X)	98 57	<u>X50</u>	<u>X50</u>	<u>Approaching level crossing in wrong direction.</u>
<u>Amend :-</u>	Newton Flotman LC (AHB-X)	108 19	<u>X50</u>	<u>X50</u>	<u>Approaching level crossing in wrong direction.</u>

SE-49

SECTION D - GENERAL INSTRUCTIONS AND NOTICES - continued

EASTERN REGION SECTIONAL APPENDIX (SOUTHERN AREA) - continued

Running Lines and Signalling System	Location	M. Ch.	Permanent Speed Restrictions		Remarks
			Down m.p.h.	Up m.p.h.	
<u>LIVERPOOL STREET TO NORWICH - continued</u>					
<u>Page 61</u>					
<u>Delete all details between Swainsthorpe and Trowse Lower Jn and substitute :-</u>					
	Swainsthorpe LC	109 54			
	Trowse Lower Jn (see page 103)	<u>113 68</u> 123 00			
			<u>90</u>	<u>80</u>	111m. 15chs. and 110m. 55chs.
			<u>40</u>	<u>40</u>	111m. 15chs. and 112m. 62chs.
					112m. 62chs. and 113m. 46chs.
			<u>35</u>		113m. 46chs. and 123m.p.
					C. Up at 113m. 21chs.
					C. Up at 113m. 61chs. (395 yards before reaching Trowse Lower Jn Starting Signal).
					(10.SD)

SE-50

SECTION D - GENERAL INSTRUCTIONS AND NOTICES - continued

EASTERN REGION SECTIONAL APPENDIX (SOUTHERN AREA) - continued

Running Lines and Signalling System	Location	M. Ch.	Permanent Speed Restrictions		Remarks
			Down m.p.h.	Up m.p.h.	
<u>WICKFORD JN. TO SOUTHMINSTER</u> Page 68 (Page 20, SD.PON) At Southminster Add:-			15	15	<u>45m. 23chs. and 45m. 42chs.</u> (10.SD)
<u>EAST SUFFOLK JN TO OULTON BROAD NORTH JN</u> Page 73 (Page 23, SD.PON) Amend :-	Ufford LC (AOCL)	81 60	50	50	<u>Approaching level crossing.</u> (10.SD)

SE-51

SECTION D - GENERAL INSTRUCTIONS AND NOTICES - continued

EASTERN REGION SECTIONAL APPENDIX (SOUTHERN AREA) - continued

Running Lines and Signalling System	Location	M. Ch.	Permanent Speed Restrictions		Remarks
			Down m.p.h.	Up m.p.h.	
<p><u>NORWICH TO LOWESTOFT</u></p> <p>Page 78 (Page A44, SD PON)</p> <p>Delete all details between Norwich Thorpe Jn and Whitlingham Jn and substitute :-</p>					
	Norwich	0 00	15		
	Norwich (NO)	0 23			
	Thorpe Jn (See page 61)	0 29			
					<p><u>All lines. 0m.p. and 0m. 38chs.</u></p> <p>Norwich (NO) signal box area between Norwich and Crown Point.</p>

SE-52

SECTION D - GENERAL INSTRUCTIONS AND NOTICES - continued

EASTERN REGION SECTIONAL APPENDIX (SOUTHERN AREA) - continued

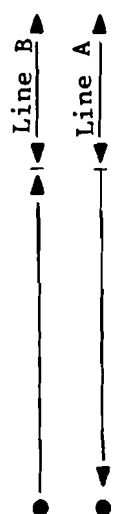
Running Lines and Signalling System	Location	M. Ch.	Permanent Speed Restrictions		Remarks
			Down m.p.h.	Up m.p.h.	
<p><u>NORWICH TO LOWESTOFT - continued</u></p> <p><u>Page 78 (Page A44, SD PON) - continued</u></p> <p><u>Delete</u> all details between Norwich Thorpe Jn and Whitlingham Jn and <u>substitute - continued :-</u></p>					
		0 35			
	Crown Point	0 60		15	<u>All lines. Om. 38chs. and Om.p.</u>
	Whitlingham Jn (WH) (See page 79)	1 69	25		<u>To Cromer line.</u>

SECTION D - GENERAL INSTRUCTIONS AND NOTICES - continued

EASTERN REGION SECTIONAL APPENDIX (SOUTHERN AREA) - continued

Running Lines and Signalling System	Location	M. Ch.	Permanent Speed Restrictions		Remarks
			Down m.p.h.	Up m.p.h.	
<u>Page 81</u>					
<u>REEDHAM JN TO YARMOUTH</u>					
At Berney Arms					
<u>Delete :-</u>			<u>30</u>	<u>30</u>	<u>15$\frac{1}{2}$m.p. and 19m. 24chs.</u>
<u>Substitute :-</u>			<u>30</u>	<u>30</u>	<u>13m. 52chs. and 19m. 24chs.</u>
					(10.SD)

SECTION D - GENERAL INSTRUCTIONS AND NOTICES - continuedEASTERN REGION SECTION APPENDIX (SOUTHERN AREA) - continuedOTHER GENERAL INSTRUCTIONSPage 297Add :- DOCKLANDS LIGHT RAILWAY LINE BETWEEN BOW JN AND STRATFORD STATION
(ADJACENT TO THE B.R. UP ELECTRIC LINE)

B.R. staff must observe the provisions of the previous instructions on pages 294 to 297 headed, "Instructions to Traincrews Working other than D.C. Electric trains and other staff concerned working over or in the vicinity of D.C. Electrified lines", except that reference to Electrical Control Operator should be read as Controller and Supervisor at Poplar Control Centre, who can be contacted via the Signaller at Bow Jn or on British Telecom 538 3440.

The Docklands Light Railway when fully operational will work automatically without lineside signals, using Driverless trains which will approach in either direction travelling at a maximum speed of 50m.p.h. Each train will convey a member of Docklands Light Railway staff called a "Train Captain".

Docklands trains will not sound a warning to persons on or near the line, etc. and B.R. Staff must not, therefore, except in emergency go onto the Docklands Light Railway. Posts are provided in the 10 Foot between the Up Electric line and the Docklands line to identify the point beyond which staff must not proceed. When staff stand clear of the Up Electric line they must align themselves between the posts.

In the vicinity of the Bow Junction signal box and overbridge 609 (Fairfield Road), Staff must not, except in emergency, proceed beyond the fence between the B.R. and Docklands line. If unavoidable circumstances compel staff to remain between the B.R. and Docklands lines when trains pass, they must lay down against the B.R. side of the fence. It is important that this instruction is observed as the collector shoes of Docklands Light Railway trains will pass in close proximity to the Docklands side of the fence.

If an emergency/mishap occurs on B.R. lines requiring the stopping of trains on the Docklands Light Railway, standard B.R. protection arrangements must be observed and advice given to the Poplar Control Centre by the quickest available means. It should be noted that the placing of a Track Circuit Operating Clip on the Docklands line will stop a train which is in automatic mode.

(10.SD)

SECTION D - GENERAL INSTRUCTIONS AND NOTICES - continuedEASTERN REGION SECTIONAL APPENDIX (SOUTHERN AREA) - continuedLOCAL INSTRUCTIONSINDEXPage 301

Page

Add:-

Oulton Broad South and Beccles - Between

322

LOCAL INSTRUCTIONSPage 322EAST SUFFOLK JN TO OULTON BROAD NORTH JNAdd:-BETWEEN OULTON BROAD SOUTH AND BECCLES

2J49 16 25 Lowestoft-Beccles train is authorised to proceed from Oulton Broad South to Beccles and return from that location to Oulton Broad South displaying the Oulton Broad South to Halesworth Full token throughout.

The Driver must obtain the permission of the Signaller at Saxmundham for the train to return from Beccles to Oulton Broad South. The token now being displayed in the rear cab.

On arrival at Oulton Broad South, the Driver must proceed to the rear cab, carry out the token return procedure and then proceed forward in the normal manner.

(10.SD)

Page 316SILVERTOWNDelete instruction and substitute :-Thomas W. Ward and Co. Private Siding

Loaded or empty 4-wheeled vehicles with a wheelbase exceeding 10' 6" (3.2m) (with the exception of POA vehicles), 80 to 100t AB 4-axled bogie vehicles and 6-wheeled vehicles must not be taken into this private siding.

POA 51t GLW open scrap wagons may be worked singly into this siding at dead slow speed, but only so far as the firms' wagon weighbridge for weighing purposes.

BCV, BDV, BEV, BPV and BQV's must be shunted into this siding at dead slow speed.

(10.SD)

SECTION D - GENERAL INSTRUCTIONS AND NOTICES - continuedMISCELLANEOUS NOTICESEXPERIMENTAL ULTRASONIC TEST TRAIN VUR 505

The above train will operate on B.R. for an experimental period and the instructions on Pages 4.15 and 4.16 of the General Appendix apply with the following modifications:-

- 2(d) The air brake test must be carried out by the Guard from the rear driving cab.
5. Whilst on running lines, the following arrangements must be applied in respect of the driving of the train:-

Whilst running from site to site under normal running conditions and during testing, the train will be driven by the Speno Driver who must be accompanied by a Motive Power Conductor.

(30)

MAXIMUM PERMISSIBLE SPEEDS OF FREIGHT ROLLING STOCK :
21.5T CAPACITY MINERAL WAGONS

The maximum speed of all MDO, MDV and ZDV/ZHV wagons, which are ex traffic MD wagons, has been reduced to 45m.p.h. in all conditions.

The basic panels for these wagons on Page C30 of the White Pages of the Working Manual for Rail Staff are amended accordingly.

(10.SD)

WORKING OF CLASS 313 AND CLASS 416 ELECTRIC MULTIPLE UNIT
TRAINS BETWEEN DALSTON WESTERN JN AND STRATFORD MARKET

Class 313 Electric Multiple Units

These units must only work between Navarino Road Jn and Stratford Market stabling sidings when either the Graham Road Curve route to Liverpool Street is not available, or when the pantographs have failed to rise. When operating between Dalston Kingsland and Stratford Market stabling sidings and return in the D.C. mode, Drivers must not advance the controller beyond Notch 2.

THESE UNITS MUST NOT RUN BEYOND STRATFORD MARKET TOWARDS NORTH WOOLWICH.

Class 416 Electric Multiple Units

Not more than two Class 416 units may be coupled together.

When two Class 416 units are running in multiple between Dalston Western Jn and Stratford Market, including the stabling sidings or return, Drivers must not advance the controller beyond Notch 2.

(UFN)

SECTION D - GENERAL INSTRUCTIONS AND NOTICES - continuedMISCELLANEOUS NOTICES - continuedBETWEEN STEPNEY EAST AND FENCHURCH STREET

Until further notice, staff of the Docklands Light Railway will be laying in track adjacent to the Up Main/Slow line between Stepney East Station (1m. 58chs.) and Fenchurch Street. Restricted clearances exist and Drivers must keep a sharp look out and be prepared to sound the warning horn as necessary.

(UFN)

BETHNAL GREEN STATION

Until Further Notice, whilst demolition work is taking place, Drivers of 4-Car EMU trains must stop their trains at the temporary stop boards provided.

(UFN)

DALSTON (KINGSLAND) STATION

The Down and Up platforms have been temporarily shortened at the Stratford end by 25 yards and only accommodate two coaches. Drivers of Down trains booked to stop at this station must bring their train to a stand at signal DW14/16. Drivers of Up trains booked to stop at this station must bring their train to a stand at the temporary stop board which has been provided adjacent to the footbridge.

(LM) (UFN)

CAMBRIDGE HEATH STATION

Whilst platform repairs are taking place, Drivers of trains must stop their trains at the temporary stop boards provided.

(UFN)

LONDON FIELDS STATION

W.e.f. 06 00 Monday 29 September, the station will reopen but platform repairs will be taking place. Whilst this work is being carried out, Drivers must stop their trains at the temporary stop boards provided.

(UFN)

SAWBRIDGEWORTH STATION

The stop board on the Up platform has been temporarily moved 9 yards towards the Country side of its former position.

(UFN)

WANSTEAD PARK STATION

Whilst platform repairs are taking place, Drivers of Up trains must stop their trains at the temporary stop boards provided.

(UFN)

SECTION D - GENERAL INSTRUCTIONS AND NOTICES - continuedMISCELLANEOUS NOTICES - continuedREPAIRS IN MOTIVE POWER DEPOTS, CARRIAGE SHEDS, WAGON REPAIR SHEDS AND WAREHOUSES

In connection with work being carried out at the undermentioned places, scaffolding or projections may be provided or unusual excavations may be made in the ground:-

Location	Nature of Work	Duration	Commencing date
Stratford T.M.D. All lines.	Repairs to Motive Power Depot. Cranes and mechanical equipment in use.	Continuously. Until Further Notice.	-
Ilford EMU Depot, Nos. 19 and 20 Roads.	Drainage.	08 00 to 17 00 daily. Until Further Notice.	-
Ilford EMU Depot, Carriage Washer Roads BLOCKED	Renewal of carriage washer plant. <u>Isolation of electrical sections 361R.</u>	Continuously. Until Further Notice.	-
Ilford EMU Depot, Ley Street Yard Nos. 1 and 1A Sidings BLOCKED	Construction work. <u>Isolation of electrical sections 361U.</u>	Continuously.	<u>From 08 30 Saturday 27 until 16 30 Sunday 28 September.</u>
Ilford EMU Depot Nos. 1, 2 and 3 Sidings BLOCKED to electric trains	Construction work. <u>Isolation of electrical sections 361BS.</u>	10 15 to 15 15. <u>Wednesday 1 October.</u>	-
Norwich Crown Point T & R.S. M.D., All lines BLOCKED	Construction work (overhead line) and track maintenance. Mechanical equipment in use. <u>Possession to be given up for passage of trains.</u>	08 00 to 17 00 daily. Until further notice.	-
Cambridge Coldham Lane Depot, No. 4 Carriage Siding and Nos. 4 and 5 Diesel Sidings.	Signalling work. <u>(See Section 'C').</u>	08 00 to 17 30. <u>Sunday 28 September.</u>	-

SECTION D - GENERAL INSTRUCTIONS AND NOTICES - continuedMISCELLANEOUS NOTICES - continuedREPAIRS IN MOTIVE POWER DEPOTS, CARRIAGE SHEDS, WAGON REPAIR SHEDS AND WAREHOUSES - continued

In connection with work being carried out at the undermentioned places, scaffolding or projections may be provided or unusual excavations may be made in the ground:-

Location	Nature of Work	Duration	Commencing date
East Ham EMU Depot, All lines.	Shed reconstruction.	Continuously. Until Further Notice.	-
East Ham EMU Depot, Washer Road BLOCKED	Repairs to washer plant. <u>Isolation of electrical sections 509A.</u>	Continuously. Until Further Notice.	-
East Ham EMU Depot, Inlet and Exit Roads BLOCKED Nos. 12, 13, 14, 15, and 16 Sidings and connections, and connections to Maintenance Shed BLOCKED to electric trains	Washer Plant renewal. <u>Isolation of electrical sections 509BCDEFGH.</u>	<u>From 21 15 Saturday 27 until 18 00 Sunday 28 September.</u>	-
East Ham EMU Depot, Nos. 10 and 11 Maintenance Shed Roads BLOCKED	Construction work. <u>Isolation of electrical sections EH10, EH11.</u>	Continuously. Until Further Notice.	<u>From 10 00 Monday 29 September.</u>
East Ham EMU Depot, Nos. 17, 18, 19 and 20 Sidings BLOCKED to electric trains	In connection with engineering work between East Ham and Barking. Crane and mechanical equipment in use. <u>Isolation of electrical sections 509J.</u>	21 15 Mon to Fri to 05 15 Tue to Sat.	<u>From Monday 29 September until Saturday 4 October.</u>

BRITISH RAIL
EASTERN REGION

SE

28

WEEKLY OPERATING NOTICE

CONTAINING

TEMPORARY SPEED RESTRICTIONS

TEMPORARY ENGINEERING WORKS

SIGNALLING AND
PERMANENT WAY ALTERATIONS

GENERAL INSTRUCTIONS AND NOTICES

SATURDAY 4 OCTOBER

TO

FRIDAY 10 OCTOBER 1986

INCLUSIVE

Trainmen must pay particular attention to works contained in this notice and keep a good look-out for handsignals which may be exhibited in accordance with the Rules and Regulations.

Work at places other than those mentioned may be in progress and Drivers must be on the look-out and be prepared to stop or run at reduced speed when, and where, handsignals may be exhibited.

SECTION A

TEMPORARY SPEED RESTRICTIONS

(Until further notice unless otherwise specified)

Warning Boards and Indicators provided unless otherwise shown.

† Indicates that the Warning Boards and Indicators will be moved as the work progresses. Where two speeds are shown for a restriction e.g. $\frac{20}{40}$ the Rule

Book, Section U, Clause 1.2 applies.

Location	Lines affected		Mileage at or between		Restr- iction m.p.h.	Remarks
			M. Ch.	M. Ch.		
<u>LIVERPOOL STREET TO NORWICH</u>						
1 Bethnal Green Station Jn and Bow Jn	Down Electric	Up Electric	1 55	2 12	20	Trackwork. <u>From 18 00</u> <u>Sunday 5</u> <u>October.</u> (86/28)
2 Ilford Car Sheds and Goodmayes Station	Down Main	-	8 37	8 55	20	Trackwork. <u>Warning board</u> <u>also provided</u> <u>on Down</u> <u>Electric</u> <u>line at 7m.</u> <u>72chs.</u> (86/23)
3 Goodmayes Station and Ilford Car Sheds	-	Up Main	8 55	8 37	20	Trackwork. <u>Warning board</u> <u>also provided</u> <u>on Up</u> <u>Electric</u> <u>line at 9m.</u> <u>23chs.</u> (86/23)
4 Romford and Gidea Park Station	Down Electric	Up Electric	12 15	12 48	20	Trackwork. (86/24)
5 Romford Station and Gidea Park Station	Down Main	-	12 37 †	13 32	30	Trackwork. <u>From 05 00</u> <u>Tuesday 7</u> <u>until 14 00</u> <u>Friday 10</u> <u>October.</u>

SECTION A - TEMPORARY SPEED RESTRICTIONS - continued

Location	Lines affected		Mileage		Restr- iction	Remarks
			M. Ch. M. Ch.	m.p.h.		
<u>LIVERPOOL STREET TO NORWICH - continued</u>						
6 Gidea Park Station and Romford Station	-	Up Main	13 32 †	12 37	30	Trackwork. <u>Warning board also provided on Up Electric line at 13m. 52chs. From 05 00 Tuesday 7 until 14 00 Friday 10 October.</u>
7 Harold Wood and Brentwood	Down Main	-	15 02	15 42	<u>20</u> 40	Condition of track. (85/61)
8 Brentwood and Ingatestone	Down Main	-	19 65	20 33	50	Condition of track. (86/14)
9 Church Lane LC and Chelmsford	Down	Up	29 24	29 57	20	Trackwork. (86/26)
10 Chelmsford and New Hall G.F.	Down	-	30 50	30 65	50	Condition of track. (86/12)
11 New Hall G.F. and Hatfield Peverel	Down	-	35 10 †	35 40	40	Trackwork. (86/26) <u>Until 23 59 Saturday 4 October.</u>
12 New Hall G.F. and Witham	Down	-	35 40 †	38 40	60	Trackwork. (86/26) <u>Until 23 59 Saturday 4 October.</u>
13 Witham and New Hall G.F.	-	Up	36 20	35 65	20	Trackwork. <u>From 23 00 Saturday 4 October.</u> (86/28)

SECTION A - TEMPORARY SPEED RESTRICTIONS - continued

Location	Lines affected		Mileage		Restr- iction m.p.h.	Remarks
			at M.	or between Ch. M. Ch.		
<u>LIVERPOOL STREET TO NORWICH - continued</u>						
14 Hatfield Peverel and Witham	Down	-	37 20 †	38 00	40	Condition of track. <u>From 23 59</u> <u>Saturday 4</u> <u>October.</u> (86/28)
15 Kelvedon	-	Up	42 25	42 10	<u>50</u> 80	Condition of track. (86/7)
16 Long Green LC and Marks Tey Jn	Down	-	46 36	46 55	20	Earthwork. (86/23) <u>Until 10 00</u> <u>Wednesday 8</u> <u>October.</u>
17 Barham and Baylham LC	Down	Up	74 70	75 05	30	Bridgework. (No. 262). (86/26) <u>Until 10 00</u> <u>Wednesday 8</u> <u>October.</u>
18 Palgrave LC and Thornham Road LC	-	Up	91 40	91 20	20	Earthwork. <u>From 10 00</u> <u>Wednesday 8</u> <u>October.</u> (86/28)
19 Diss and Audley End LC	Down	Up	95 10	95 15	20	Bridgework (No. 315) (86/26) <u>Until 10 00</u> <u>Wednesday 8</u> <u>October.</u>
20 Swainsthorpe and Trowse Lower Jn	Down	-	112 30	112 70	30	Trackwork. (86/27)

SHENFIELD JN TO SOUTHEND VICTORIA

21 Billericay and Wickford Station	Down	-	26 10	26 44	40	Condition of track. (86/14)
---------------------------------------	------	---	-------	-------	----	-----------------------------------

SECTION A - TEMPORARY SPEED RESTRICTIONS - continued

Location	Lines affected		Mileage		Restr- iction m.p.h.	Remarks
			at or between M. Ch. M. Ch.			
<u>SHENFIELD JN TO SOUTHEND VICTORIA - continued</u>						
22 Wick Lane LC and Rayleigh	Down	-	31 35	31 75	40	Condition of embankment. (84/41)
<u>WICKFORD JN TO SOUTHMINSTER</u>						
23 Althorne LC and Burnham-on- Crouch	Single	*	41 10 †	42 10	20	Trackwork. (85/45)
<u>COLCHESTER TO CLACTON</u>						
24 Colchester Road LC and Wivenhoe	-	Up	57 72 †	57 12	40	Condition of track. (86/26)
<u>MANNINGTREE SOUTH JN TO HARWICH</u>						
25 Bradfield LC and Wrabness	Down	-	63 37	63 39	40	Earthwork. (85/55) <u>Until 10 00</u> <u>Monday 6</u> <u>October.</u>
26 Parkeston Goods Jn and Wrabness	-	Up	66 70	66 10	<u>30</u> 50	Condition of track. (86/3)
<u>EAST SUFFOLK JN TO OULTON BROAD NORTH JN</u>						
27 Bealings LC and Westerfield Jn	-	Up	74 60 †	73 44	20	Trackwork. (86/21)
<u>WESTERFIELD JN TO FELIXSTOWE</u>						
28 Trimley	Single		82 55	82 69	20	Trackwork. <u>From 10 00</u> <u>Saturday 4</u> <u>October.</u> (86/28)

SECTION A - TEMPORARY SPEED RESTRICTIONS - continued

Location	Lines affected	Mileage at or between				Restr- iction m.p.h.	Remarks
		M.	Ch.	M.	Ch.		
<u>NORWICH TO LOWESTOFT</u>							
29 Thorpe Jn and Whitlingham Jn	Down	Up	0 36	0 44	20	Trackwork. (85/20)	
30 Whitlingham Jn and Brundall Jn	Down	Up	4 59 †	5 62	20	Trackwork. <u>From 09 00</u> <u>Sunday 5</u> <u>October.</u> (86/28)	
<u>BETHNAL GREEN JN TO KING'S LYNN</u>							
31 Cambridge Heath	Down Suburban	Up Suburban	1 57	1 67	20	Platform work. (86/24)	
32 Brimsdown and Waltham Cross	Down	Up	11 54	12 12	20	Trackwork. (86/11)	
33 Cheshunt Station and Wharf Road LC	Down	-	15 12 †	15 79	40	Trackwork. (86/26)	
34 Wharf Road LC and Cheshunt Station	-	Up	15 79 †	15 12	30	Trackwork. (86/26)	
35 Sawbridgeworth and Harlow Mill	-	Up	24 76	24 70	60	Condition of track. (86/16)	
<u>COLDHAM LANE JN TO HAUGHLEY JN</u>							
36 Elmswell LC and Haughley Jn	Down	-	37 15 †	38 00	30	Trackwork. (86/27)	
<u>ELY NORTH JN TO PETERBOROUGH, CRESCENT JN</u>							
37 Third Drove LC and Welney Road LC	Down	Up	78 00	78 18	20	Condition of track. (86/21)	
38 Third Drove LC and Welney Road LC	Down	Up	78 42	78 60	20	Condition of track. (86/21)	

SECTION A - TEMPORARY SPEED RESTRICTIONS - continued

Location	Lines affected		Mileage		Restr- iction	Remarks
			at or between			
			M. Ch. M. Ch.	m.p.h.		
<u>ELY NORTH JN TO PETERBOROUGH, CRESCENT JN - continued</u>						
39 March East Jn and Badgeney Road LC	-	Up Main	85 40	85 29	20	Trackwork. (85/54) <u>Warning board</u> <u>positioned at</u> <u>signal ME.45.</u> <u>Additional</u> <u>warning board</u> <u>provided on</u> <u>the March</u> <u>East Jn to</u> <u>Wisbech line,</u> <u>positioned at</u> <u>signal ME.52.</u>
40 Three Horse Shoes No. 3 LC	Down	Up	90 74	90 78	<u>20</u> 50	Condition of track. (86/24)

Warning board at 100m. 23chs. (on the Down line) applies only to trains proceeding over the Two-Way Goods line to Fly Ash Inspection Siding connection at Peterborough Station (North). Until 09 00 Monday 6 October.

ELY NORTH JN TO TROWSE LOWER JN

41 Eaton LC and Trowse Lower Jn	Down	Up	121 60	121 64	20	Bridgework (Nos. 1640 and 1640A). (86/23)
------------------------------------	------	----	--------	--------	----	--

FENCHURCH STREET TO SHOEBURYNES

42 Basildon and Pitsea	Down	-	25 44	25 47	30	Trackwork. <u>From 00 01</u> <u>Sunday 5</u> <u>until 14 00</u> <u>Friday 10</u> <u>October.</u>
---------------------------	------	---	-------	-------	----	---

UPPER HOLLOWAY TO BARKING, TILBURY LINE JN WEST

43 South Tottenham East Jn and Black Horse Road	Down	-	6 45	6 57	20	Condition of track. (85/18)
---	------	---	------	------	----	-----------------------------------

SECTION A - TEMPORARY SPEED RESTRICTIONS - continued

Location	Lines affected	Mileage		Restr- iction	Remarks	
		at or between	M. Ch. M. Ch.			
		M.	Ch.	m.p.h.		
<u>BARKING, TILBURY LINE JN EAST TO TILBURY RIVERSIDE</u>						
44 Jurgens LC and West Thurrock Jn	Down	Up	17 20	17 30	20	Trackwork. (86/26) <u>Until 14 00</u> <u>Friday 10</u> <u>October.</u>
<u>TILBURY RIVERSIDE TO PITSEA</u>						
45 Stanford-le- Hope and Gardners LC	Down	-	30 11	30 60	40	Condition of track. (86/1)

SECTION B

TEMPORARY ENGINEERING WORKS

At or between	Lines affected	Remarks
<u>LIVERPOOL STREET TO NORWICH</u>		
UNTIL FURTHER NOTICE		
46	Liverpool Street Station Platforms 1 to 10 Inc.	Repairs to station roof. Mechanical equipment in use. (84/41)
47	Liverpool Street Station Platforms 1 to 18 inc.	Cleaning track. (85/21)
48	Liverpool Street Station Platforms 8, 10 and 11 to 18 inc.	Platform work and construction work. Mechanical equipment in use. (86/21)
49	Bethnal Green Station Down Main and Down and Up Suburban	08 00 to 16 00. Demolition work. (<u>See Section 'D'</u>). (85/41)
50	Bethnal Green and Bow Jn All	Signalling work. (86/25)
51	Stratford and Bow Jn Up Electric	07 30 to 18 00. Construction work. Mechanical equipment in use. (85/62)
52	Forest Gate Jn and Ilford All	07 00 to 18 00. Bridgework (No. 75A). 7m. 08chs. Mechanical equipment in use. (85/20)
53	Ilford Station All	08 00 to 17 00. Repairs to station roof and painting station. (86/2)
54	Romford Jn and Gidea Park All	Bridgework (No. 102B). 12m. 48chs. Crane and mechanical equipment in use. (85/54)
55	Ingatestone and Chelmsford Down and Up	07 30 to 18 00. Construction of bridge (No. 143A). 26m. 51chs. Mechanical equipment in use. (84/35)
56	Chelmsford and Hatfield Peverel Down and Up	07 30 to 16 00. Earthwork. 35m. 53chs. (85/27)
57	Colchester Jn and Ardleigh LC Down Main	08 00 to 17 00. Earthwork and formation renewal. 52m. 25chs. and 53m. 75chs. Mechanical equipment in use. (85/41)

SECTION B - TEMPORARY ENGINEERING WORKS - continued

At or between	Lines affected	Remarks
<u>LIVERPOOL STREET TO NORWICH - continued</u>		
UNTIL FURTHER NOTICE - continued		
58 Manningtree North Jn and Bentley LC	Down and Up <u>Between Trains</u>	07 00 to 18 00. Tree felling, bridgework (No. 229) and earthwork. 60m. 06chs. and 61m. 06chs. Crane and mechanical equipment in use. (85/15)
59 Ipswich Goods Jn and Needham Market	Down Main	08 00 to 16 00. Construction work. 69% and 76m.p. (86/19)
60 East Suffolk Jn and Claydon LC	Down and Up	08 00 to 16 00. Bridgework (No.254A). 70m. 17chs. (85/58)
61 Barham and Baylham LC	Down and Up	Bridgework (No. 262). 74m. 73chs. Mechanical equipment in use. <u>Until 07 30 Sunday 5 October.</u> (86/27)
62 Mellis	Down and Up	07 30 to 18 00. Demolition work. 91 $\frac{1}{2}$ m.p. Mechanical equipment in use. (86/12)
63 Mellis and Trowse Lower Jn	All <u>Between Trains</u>	07 30 to 18 00. Signalling work. Points and signals disconnected. (86/15)
64 Diss and Mellis	Up	08 00 to 15 00. Construction work. 94m. 05chs. and 94m.p. (86/17)
65 Diss	Down and Up	07 00 to 19 00. Earthwork. Crane and mechanical equipment in use. (85/27)
66 Diss and Audley End LC	Down and Up	Bridgework (No. 315). 95m. 29chs. (86/16)
67 Diss and Tivetshall Jn	Down and Up	07 30 to 18 00. Demolition work 97m 50chs. Mechanical equipment in use. (86/12)
68 Gissing LC	Down and Up	08 00 to 16 00. Level crossing road repairs. 98m. 56chs. Mechanical equipment in use. (86/26)

SECTION B - TEMPORARY ENGINEERING WORKS - continued

<u>At or between</u>	<u>Lines affected</u>	<u>Remarks</u>
<u>LIVERPOOL STREET TO NORWICH - continued</u>		
UNTIL FURTHER NOTICE - continued		
69 Hales Street LC	Down and Up	08 00 to 16 00. Level crossing road repairs. 100m. 26chs. Mechanical equipment in use. <u>From 08 00 Sunday 5 October.</u> (86/28)
70 Tivetshall Jn	Down and Up	07 30 to 18 00. Demolition work. 100 $\frac{3}{4}$ m.p. Mechanical equipment in use. <u>Until 18 00 Saturday 4 October.</u> (86/8)
71 Tivetshall Jn	Down and Up	07 30 to 18 00. Demolition work and level crossing road repairs. (Tivetshall Jn LC). 100 $\frac{3}{4}$ m.p. Mechanical equipment in use. <u>From 07 30 Sunday 5 October.</u> (86/28)
72 Tivetshall Jn and Swainsthorpe	Down and Up <u>Between Trains</u>	07 30 to 18 00. Bridgework (Nos. 328 and 331A) and demolition work. 103m. 13chs. and 104m. 59chs. Crane and mechanical equipment in use. (86/8)
73 Newton Flotman LC	Down and Up	08 00 to 16 00. Level crossing road repairs. 108m. 17chs. Mechanical equipment in use. (86/26)
74 Swainsthorpe	Down and Up <u>Between Trains</u>	07 30 to 18 00. Demolition work. 109 $\frac{3}{4}$ m.p. Mechanical equipment in use. (86/8)
75 Swainsthorpe and Trowse Lower Jn.	Down and Up	07 00 to 16 00. Bridgework (No. 346). 110m. 62chs. Mechanical equipment in use. (86/25)
76 Trowse Lower Jn and Norwich Station	All <u>Between Trains</u>	07 00 to 17 00. Construction work (overhead line), earthwork, track maintenance and signalling work. Points and signals disconnected. (86/7)
77 Trowse Swing Bridge	Down and Up <u>Between Trains</u>	Bridgework (No. 356). 123m. 36chs. Crane and mechanical equipment in use. (85/33)

SECTION B - TEMPORARY ENGINEERING WORKS - continued

<u>At or between</u>	<u>Lines affected</u>	<u>Remarks</u>
----------------------	-----------------------	----------------

LIVERPOOL STREET TO NORWICH - continued

UNTIL FURTHER NOTICE - continued

78	Trowse Swing Bridge and Thorpe Jn	Down and Up <u>Between Trains</u>	07 30 to 18 00. Construction work. 123 $\frac{1}{2}$ m.p. Crane and mechanical equipment in use. (86/3)
79	Norwich Station	All	Track renewal, platform work and earthwork. Crane and mechanical equipment in use. (85/62)

FRIDAY 3 TO MONDAY 6 OCTOBER

80	Bethnal Green and Stratford (London End)	Down and Up Electric BLOCKED	23 00 Fri to 05 00 Mon. Track maintenance, track renewal and overhead line work. Mechanical equipment in use. <u>Isolation of electrical sections 309A, 310B.</u> <u>Trains to travel over Main lines.</u>
----	--	------------------------------------	--

SATURDAY 4 OCTOBER

81	Liverpool Street Station	Platforms 8, 9 and 10 BLOCKED Platform 7 BLOCKED to electric trains	05 00 to 12 30. Repairs to station roof and overhead line work. <u>Isolation of electrical sections 305CEFGH.</u> <u>Trains to be replatformed as necessary.</u>
----	--------------------------	--	--

SATURDAY 4 TO SUNDAY 5 OCTOBER

82	Chadwell Heath Jn and Gidea Park Station Jn	Down and Up Electric BLOCKED	20 30 Sat to 22 00 Sun. Track renewal, formation renewal, track maintenance and overhead line work. Mechanical equipment in use. <u>Isolation of electrical sections 325DE, 326AB.</u> <u>Trains to travel over Main lines.</u>
83	Diss and Swainsthorpe	Down and Up Down and Up BLOCKED Down and Up	00 01 to 23 45 Sat) Track maintenance,)bridgework (No. 23 45 Sat to 07 00) 315), demolition)work and signalling)work. Crane and 07 00 to 23 59 Sun) mechanical)equipment in use.) <u>(See Section 'C').</u>

SECTION B - TEMPORARY ENGINEERING WORKS - continued

<u>At or between</u>	<u>Lines affected</u>	<u>Remarks</u>
<u>LIVERPOOL STREET TO NORWICH - continued</u>		
<u>SATURDAY/SUNDAY 4/5 OCTOBER - continued</u>		
89 Ipswich Goods Jn and Claydon LC	Down Main BLOCKED	23 45 to 07 00. Unloading materials. <u>Possession to be given up for passage of 1Y02 02 20 Liverpool Street to Stowmarket.</u>
90 Claydon LC and Stowmarket	Down and Up Main BLOCKED	23 40 to 07 30. Track maintenance and bridgework (No. 262). Mechanical equipment in use. <u>Possession to be given up for passage of 1Y02 02 20 Liverpool Street to Stowmarket over Down Main line.</u>
91 Cow Green and Diss	Up BLOCKED Down BLOCKED	22 00 to 07 15) Earthwork. Crane and mechanical equipment in use. <u>Possession to be given up for passage of 0T92 07 30 Ipswich to Diss over Down line.</u>
92 Swainsthorpe and Trowse Lower Jn	Up BLOCKED Down BLOCKED	22 00 to 06 45) Track maintenance. Crane and mechanical equipment in use. <u>06 45 to 16 00 Sun Possession to be given up for passage of trains.</u>
93 Trowse Yard and Norwich	'C' line/Up Main BLOCKED Down Main/'W' line BLOCKED	22 00 to 16 00) Track renewal and signalling work. 23 55 to 06 45) Mechanical equipment in use. <u>23 55 Sat to 06 45 Possession to be given up for passage of 1P04 02 10 Liverpool Street to Yarmouth over Down Main/'W' line. 06 45 to 16 00 Sun Single line working over Down Main/'W' line.</u>

SECTION B - TEMPORARY ENGINEERING WORKS - continued

At or between	Lines affected	Remarks
<u>LIVERPOOL STREET TO NORWICH - continued</u>		
SATURDAY/SUNDAY 4/5 AND SUNDAY 5 OCTOBER		
94 Liverpool Street and Bethnal Green	Down and Up Suburban BLOCKED to electric trains	23 15 Sat to 18 00)Repairs to station)roof and overhead)work. Mechanical)equipment in use.) <u>Isolation of</u>
Liverpool Street Station	Platforms 9 and 10 BLOCKED to electric trains	23 15 Sat to 04 15) <u>electrical</u>) <u>sections 305 and</u>) <u>306. Electric</u>) <u>trains to travel</u>) <u>over Main or</u>
	Platforms 1 to 8 inc. BLOCKED	23 15 Sat to 18 00) <u>Electric lines.</u>) <u>Trains to be</u>) <u>replatformed as</u>) <u>necessary.</u>
	Locomotive Holding Sidings BLOCKED to electric trains	23 15 Sat to 18 00)))))
	Platforms 9 and 10 BLOCKED	04 15 to 18 00 Sun)))
95 Church Lane LC and New Hall G.F.	Up BLOCKED Down BLOCKED Up	23 25 Sat to 13 45)Track maintenance,)track renewal, 23 45 Sat to 13 50)reballasting and)overhead line work. 13 45 to 16 00 Sun)Mechanical)equipment in use.) <u>Possession to be</u>) <u>given up for</u>) <u>passage of 1Y02</u>) <u>02 20 Liverpool</u>) <u>Street to</u>) <u>Stowmarket and</u>) <u>1F04 09 20</u>) <u>Liverpool Street to</u>) <u>Harwich Parkeston</u>) <u>Quay over Down</u>) <u>line, and for</u>) <u>passage of 1C01</u>) <u>07 25 Harwich</u>) <u>Parkeston Quay to</u>) <u>Liverpool Street</u>) <u>over Down line</u>) <u>under single line</u>) <u>working.</u>

SECTION B - TEMPORARY ENGINEERING WORKS - continued

At or between	Lines affected	Remarks
---------------	----------------	---------

LIVERPOOL STREET TO NORWICH - continued

SUNDAY 5 OCTOBER

96	Liverpool Street Station	Platform 11 BLOCKED Platform 12, and connections between Main lines and Platforms 13 and 14 BLOCKED to electric trains	03 30 to 08 00. Construction work. Mechanical equipment in use. <u>Isolation of electrical sections 304ABE. Electric trains to/from platforms 13 and 14 to travel over electric lines. Trains to be replatformed as necessary.</u>
97	Bethnal Green and Bow Jn	Down and Up Main	08 00 to 18 00. Signalling work.
98	Stratford (Country End)	Down and Up Main and Down Electric	08 00 to 16 00. Signalling work (No. 270 points). Points disconnected.
99	Gidea Park (Country End)	Down and Up Electric	08 00 to 16 00. Signalling work (No. 40A points).
100	Witham and Colchester	All BLOCKED to electric trains	00 15 to 07 15. In connection with engineering work. <u>Isolation of electrical sections 337, 338, 339DEFGH, 340ABCD.</u>
101	Hill House G.F. and Colchester	Down and Up Main BLOCKED	00 15 to 07 15. Bridgework (No. 205), overhead line work and track maintenance. Mechanical equipment in use. <u>Possession to be given up for passage of 1Y02 02 20 Liverpool Street to Stowmarket over Up Main line under single line working.</u>
102	Norwich Station	Platform 5 and Middle Siding BLOCKED	06 00 to 15 00. Reballasting. Mechanical equipment in use. <u>Trains to be replatformed as necessary.</u>

SUNDAY/MONDAY 5/6 OCTOBER

103	East Suffolk Jn and Stowmarket	Down Main BLOCKED	23 00 to 04 00. Unloading materials. <u>Single line working over Up Main line.</u>
-----	--------------------------------	----------------------	--

SECTION B - TEMPORARY ENGINEERING WORKS - continued

At or between	Lines affected	Remarks
---------------	----------------	---------

LIVERPOOL STREET TO NORWICH - continued

MONDAY 6 OCTOBER

104	Stratford (London End) and Ilford Car Sheds (Country End Jn)	Down and Up Main BLOCKED to electric trains	01 00 to 05 00. In connection with engineering work between Forest Gate Jn and Ilford Car Sheds. <u>Isolation of electrical sections 319A, 320D, 323D, 324AB. Electric trains to travel over Electric lines.</u>
105	Forest Gate Jn and Ilford Car Sheds (Country End Jn)	Down and Up Main BLOCKED	01 00 to 05 00. Overhead line work and repairs to platform awnings (Ilford Station). <u>Trains to travel over Electric lines.</u>
106	Hill House G.F. and Stanway G.F.	Down Main BLOCKED	00 15 to 04 40. Track maintenance. Mechanical equipment in use. <u>Single line working over Up Main line.</u>
107	Colchester and Hythe Jn	Down Clacton Avoiding and Clacton Single/ Down and Up Clacton BLOCKED)01 00 to 04 45. Overhead line work.) <u>Isolation of electrical sections 339K, 340N, 381E, 382A. Electric trains to be replatformed as necessary.</u>)
	Colchester	Platform 5 and Bridge Road BLOCKED to electric trains))))

MONDAY 6 AND TUESDAY 7 OCTOBER

108	Liverpool Street Station	Platform 10 BLOCKED	10 00 to 15 30 daily. Repairs to station roof. <u>Isolation of electrical sections 305H. Trains to be replatformed as necessary.</u>
-----	--------------------------------	------------------------	--

SECTION B - TEMPORARY ENGINEERING WORKS - continued

At or between	Lines affected	Remarks
<u>LIVERPOOL STREET TO NORWICH - continued</u>		
MONDAY 6 TO WEDNESDAY 8 OCTOBER		
109 Barham and East Suffolk Jn	Up Main BLOCKED	23 55 Mon and Tue to 05 30 Tue and Wed. Track maintenance. Mechanical equipment in use. <u>Single line working over Down Main line.</u>
110 Trowse Yard and Norwich Station	All BLOCKED	23 15 Mon and Tue to 05 00 Tue and Wed. Track maintenance. Mechanical equipment in use. <u>Possession to be given up for passage of trains.</u>
MONDAY 6 TO THURSDAY 9 OCTOBER		
111 Chadwell Heath Jn and Gidea Park Station Jn	Down and Up Electric BLOCKED	10 15 to 15 15 daily. Track maintenance and loading materials. Mechanical equipment in use. <u>Trains to travel over Main lines.</u>
MONDAY 6 TO FRIDAY 10 OCTOBER		
112 Romford Jn and Gidea Park Jn	Down and Up Main BLOCKED	22 10 Mon to Thu to 05 00 Tue to Fri. Track maintenance, unloading materials and undertrack excavation. Mechanical equipment in use. <u>Trains to travel over Electric lines. 23 15 Mon to Thu to 05 00 Tue to Fri. Isolation of electrical sections 327BD, 328BC.</u>
113 Swainsthorpe and Trowse Lower Jn	Up BLOCKED Down BLOCKED	22 00 Mon to Thu)Track maintenance to 05 00 Tue to Fri)and track renewal. 23 45 Mon to Thu)Mechanical to 04 30 Tue to Fri)equipment in use.) <u>Possession to be given up for passage of trains.</u>
MONDAY 6 TO SATURDAY 11 OCTOBER		
114 Liverpool Street Station	Platforms 1, 2, 3 and 4 BLOCKED	23 00 Mon to Fri to 06 20 Tue to Sat. Repairs to station roof. <u>Isolation of electrical sections 306ABC. Trains to be replatformed as necessary.</u>

SECTION B - TEMPORARY ENGINEERING WORKS - continued

At or between	Lines affected	Remarks
<u>LIVERPOOL STREET TO NORWICH - continued</u>		
MONDAY 6 TO SATURDAY 11 OCTOBER - continued		
115 Bethnal Green and Stratford (London End)	Down and Up Electric BLOCKED	23 00 Mon to Fri to 05 00 Tue to Sat. Overhead line work and track maintenance. Mechanical equipment in use. <u>Isolation of electrical sections 309A, 310B. Trains to travel over Main lines.</u>
116 Colchester and Hythe Jn	Down Clacton Avoiding and Clacton Single/ Down and Up Clacton BLOCKED)23 59 Mon to Fri to 04 45 Tue to Sat.)Overhead line work. Mechanical)equipment in use. <u>Isolation of)electrical sections 339K, 340N,)381E, 382A. Possession to be given)up for passage of Engineers' trains.)Electric trains to be replatformed)as necessary.</u>
Colchester	Platform 5 and Bridge Road BLOCKED to electric trains)))
TUESDAY 7 AND WEDNESDAY 8 OCTOBER		
117 Chelmsford and Church Lane LC	Up BLOCKED	00 10 to 05 00 daily. Track maintenance and track renewal. <u>Single line working over Down line.</u>
WEDNESDAY 8 TO FRIDAY 10 OCTOBER		
118 Ardleigh LC and Manningtree North Jn	Down BLOCKED	23 30 Wed and Thu to 05 00 Thu and Fri. Track maintenance. Mechanical equipment in use. <u>Single line working over Up line.</u>
119 Ipswich Station and East Suffolk Jn	All BLOCKED	23 30 Wed and Thu to 05 30 Thu and Fri. Track maintenance. Mechanical equipment in use. <u>Possession to be given up for passage of trains.</u>

SECTION B - TEMPORARY ENGINEERING WORKS - continued

At or between	Lines affected	Remarks
---------------	----------------	---------

NAVARINO ROAD JN TO NORTH WOOLWICH

UNTIL FURTHER NOTICE

120	Highbury and Homerton	All	07 30 to 18 00. Earthwork and construction work. Mechanical equipment in use. (86/1)
-----	-----------------------	-----	---

SUNDAY 5 OCTOBER

121	Dalston Western Jn and Hackney Central	All BLOCKED to AC electric trains	08 00 to 22 00. In connection with engineering work between Bethnal Green and Hackney Downs. <u>Isolation of electrical sections 314DEF.</u>
122	Channelsea South Jn and North Woolwich	All BLOCKED	00 15 to 08 00. Tunnelwork (Stratford Low Level and Silvertown Tunnels) and drainage. Crane and mechanical equipment in use. <u>Isolation of electrical sections 701, 702, 703 and 704.</u>

WEDNESDAY 8 AND THURSDAY 9 OCTOBER

123	Stratford Low Level and North Woolwich	All BLOCKED	00 15 to 05 30 daily. Unloading materials 4 and 8 ³ / ₄ m.p. <u>Isolation of electrical sections 701, 702, 703, 704, 705A, 706C.</u>
-----	--	----------------	--

CHANNELSEA SOUTH JN TO STRATFORD CENTRAL JN WEST

UNTIL FURTHER NOTICE

124	Channelsea South Jn and Stratford Central Jn West	Down and Up BLOCKED to electric trains	In connection with engineering work. (86/14)
-----	---	---	---

FOREST GATE JN TO WOODGRANGE PARK JN

SATURDAY 4 OCTOBER

125	Barking Station (Country End) and Forest Gate Jn	Up Tilbury/Up and Up Goods Loop BLOCKED to electric trains	00 01 to 04 00. In connection with engineering work at Barking. <u>Isolation of electrical sections 513.</u>
-----	--	---	--

SECTION B - TEMPORARY ENGINEERING WORKS - continued

At or between	Lines affected	Remarks
<u>FOREST GATE JN TO WOODGRANGE PARK JN - continued</u>		
SUNDAY 5 TO MONDAY 6 OCTOBER		
126 Forest Gate Jn and Barking Tilbury Line Jn West	All BLOCKED to electric trains	00 50 Sun to 04 00 Mon. In connection with engineering work between Woodgrange Park Jn and Barking Tilbury Line Jn West. <u>Isolation of electrical sections 512 and 513.</u>

SHENFIELD JN TO SOUTHEND VICTORIA

UNTIL FURTHER NOTICE

127 Billericay	Down and Up	07 30 to 17 30. Construction work and platform work. Mechanical equipment in use. (86/19)
128 Wickford Station	All	Platform work and earthwork. (85/63)
129 Wickford Jn	All	08 00 to 17 00. Signalling work. (85/41)
130 Rayleigh and Hockley	Down	08 00 to 17 00. Earthwork 34½ and 34¾ m.p. Mechanical equipment in use. (85/61)
131 Southend Victoria Station	All	08 00 to 18 00. Repairs to station roof. (86/20)

SATURDAY 4 OCTOBER

132 Southend Victoria Station	Platforms 2 and 3 BLOCKED	08 00 to 18 00. Repairs to station roof and painting station. <u>Isolation electrical sections 375A, 376H. Trains to be replatformed as necessary.</u>
-------------------------------	---------------------------	--

WICKFORD JN TO SOUTHMINSTER

UNTIL FURTHER NOTICE

133 Wickford Jn	All	08 00 to 17 00. Signalling work. (85/41)
-----------------	-----	---

SECTION B - TEMPORARY ENGINEERING WORKS - continued

At or between	Lines affected	Remarks
---------------	----------------	---------

WICKFORD JN TO SOUTHMINSTER - continued

UNTIL FURTHER NOTICE - continued

134	Fambridge Station	Single	07 30 to 18 00. Platform work. (85/55)
135	Burnham-on-Crouch	Single	07 30 to 18 00. Earthwork. 43m 24chs. (85/30)

WITHAM TO BRAINTREE

UNTIL FURTHER NOTICE

136	Witham and Braintree	Single	07 00 to 18 00. Construction work (Bridge No. 2102B). (86/19)
-----	----------------------	--------	---

FRIDAY/SATURDAY 3/4 OCTOBER

137	Witham and Braintree	Single BLOCKED	23 40 to 05 30. Bridgework (No.2102B) and overhead line work. Mechanical equipment in use. <u>Isolation of electrical sections 379.</u>
-----	----------------------	-------------------	---

SATURDAY/SUNDAY 4/5 OCTOBER

138	Witham and Braintree	Single BLOCKED	23 40 to 08 45. Bridgework (No.2102B). <u>Isolation of electrical sections 379.</u>
-----	----------------------	-------------------	--

MONDAY 6 TO SATURDAY 11 OCTOBER

139	Witham and Braintree	Single BLOCKED	23 40 Mon to Fri to 05 30 Tue to Sat. Bridgework (No.2102B). <u>Isolation of electrical sections 379.</u>
-----	----------------------	-------------------	--

COLCHESTER TO CLACTON

UNTIL FURTHER NOTICE

140	Colchester Jn and East Gate Jn	Down Clacton Avoiding	08 00 to 17 00. Earthwork. 52m. 25chs. and 52m. 29chs. Mechanical equipment in use. (85/38)
-----	--------------------------------	-----------------------	--

SECTION B - TEMPORARY ENGINEERING WORKS - continued

At or between	Lines affected	Remarks
<u>COLCHESTER TO CLACTON - continued</u>		
SATURDAY/SUNDAY 4/5 OCTOBER		
141 Hythe Station and Great Bentley	Down and Up BLOCKED	23 20 to 07 15. Bridgework (Wivenhoe Station footbridge), painting Wivenhoe Station, signalling work and overhead line work. Mechanical equipment in use.
SUNDAY 5 OCTOBER		
142 Colchester Jn and Clacton	All BLOCKED to electric trains	00 10 to 07 15. In connection with engineering work between Hythe Station and Great Bentley. <u>Isolation of electrical sections 381, 382, 383, 384, 385 and 386.</u>
MONDAY 6 OCTOBER		
143 Colchester and Hythe Jn	Down Clacton Avoiding and Clacton Single/ Down and Up Clacton BLOCKED)01 00 to 04 45. Overhead line work.) <u>Isolation of electrical sections</u>) <u>339K, 340N, 381E, 382A. Electric</u>) <u>trains to be replatformed as</u>) <u>necessary.</u>
Colchester	Platform 5 and Bridge Road BLOCKED to electric trains))))
MONDAY 6 TO FRIDAY 10 OCTOBER		
144 Clacton and Thorpe-le-Soken	Up BLOCKED	23 00 Mon to Thu to 05 00 Tue to Fri. Trimming lineside vegetation and track maintenance. Mechanical equipment in use. <u>Isolation of electrical sections 385G.</u>

SECTION B - TEMPORARY ENGINEERING WORKS - continued

<u>At or between</u>	<u>Lines affected</u>	<u>Remarks</u>
<u>COLCHESTER TO CLACTON - continued</u>		
MONDAY 6 TO SATURDAY 11 OCTOBER		
145 Colchester and Hythe Jn	Down Clacton Avoiding and Clacton Single/ Down and Up Clacton BLOCKED)23 59 Mon to Fri to 04 45 Tue to Sat.)Overhead line work. Mechanical equipment in use. <u>Isolation of electrical sections 339K, 340N, 381E, 382A.</u> Possession to be given up for passage of Engineers' trains.) <u>Electric trains to be replatformed as necessary.</u>
Colchester	Platform 5 and Bridge Road BLOCKED to electric trains)))

EAST GATE JN TO ST. BOTOLPHS

SUNDAY 5 OCTOBER

146 East Gate Jn and St. Botolphs	All BLOCKED to electric trains	00 10 to 07 15. In connection with engineering work between Hythe Station and Great Bentley. <u>Isolation of electrical sections 381.</u>
-----------------------------------	-----------------------------------	---

COLNE JN TO HYPHE JN

SUNDAY 5 OCTOBER

147 Colne Jn and Hythe Jn	Down and Up BLOCKED to electric trains	00 10 to 07 15. In connection with engineering work between Hythe Station and Great Bentley. <u>Isolation of electrical sections 381.</u>
---------------------------	---	---

THORPE-LE-SOKEN TO WALTON-ON-NAZE

SUNDAY 5 OCTOBER

148 Thorpe-le-Soken and Walton-on-Naze	Single BLOCKED to electric trains	00 10 to 07 15. In connection with engineering work between Hythe Station and Great Bentley. <u>Isolation of electrical sections 387.</u>
--	--------------------------------------	---

SECTION B - TEMPORARY ENGINEERING WORKS - continued

At or between	Lines affected	Remarks
---------------	----------------	---------

MANNINGTREE SOUTH JN TO HARWICH

UNTIL FURTHER NOTICE

149	Wrabness and Mistley	Up	07 30 to 17 00. Earthwork. 64m. 46chs. and 64m. 15chs. Mechanical equipment in use. (85/65)
150	Parkeston West and Harwich Town	Single	07 30 to 18 00. Track maintenance, track renewal and earthwork. 70 $\frac{1}{2}$ m.p. Mechanical equipment in use. (85/27)

SATURDAY/SUNDAY 4/5 OCTOBER

151	Mistley and Wrabness	Down BLOCKED	23 00 to 08 00. Track maintenance. 61 $\frac{1}{2}$ and 63 $\frac{1}{2}$ m.p. Mechanical equipment in use.
-----	----------------------	-----------------	--

EAST SUFFOLK JN TO OULTON BROAD NORTH JN

UNTIL FURTHER NOTICE

152	Westerfield Jn and Woodbridge	Down and Up <u>Between Trains</u>	Bridgework (No. 418A). 76m. 65chs. Mechanical equipment in use. <u>From 08 00 Monday 6 October.</u> (86/28)
-----	-------------------------------	--------------------------------------	--

MONDAY/TUESDAY 6/7 OCTOBER

153	Woodbridge and Saxmundham	All BLOCKED	23 15 to 06 15. Track maintenance. Mechanical equipment in use.
-----	---------------------------	----------------	--

MONDAY 6 TO THURSDAY 9 OCTOBER

154	Saxmundham and Oulton Broad North Jn	All BLOCKED	22 00 Mon to Wed to 05 00 Tue to Thu. Unloading materials. Mechanical equipment in use.
-----	--------------------------------------	----------------	---

WESTERFIELD JN TO FELIXSTOWE

UNTIL FURTHER NOTICE

155	Westerfield Jn and Derby Road	Single	08 00 to 16 00. Earthwork. 73m. 13chs. and 73 $\frac{1}{2}$ m.p. (85/61)
-----	-------------------------------	--------	---

SECTION B - TEMPORARY ENGINEERING WORKS - continued

At or between	Lines affected	Remarks
---------------	----------------	---------

WESTERFIELD JN TO FELIXSTOWE - continued

UNTIL FURTHER NOTICE - continued

156	Derby Road and Felixstowe Beach Jn	Single Lines	07 30 to 17 00. Earthwork. 82% and 83m.p. Mechanical equipment in use. (86/1)
-----	------------------------------------	--------------	---

SATURDAY/SUNDAY 4/5 OCTOBER

157	Derby Road and Felixstowe Beach Jn	All Lines BLOCKED	22 00 to 18 00. Earthwork. Mechanical equipment in use.
-----	------------------------------------	----------------------	---

NORWICH TO LOWESTOFT

UNTIL FURTHER NOTICE

158	Norwich Station	All	Track renewal, platform work and earthwork. Crane and mechanical equipment in use. (85/62)
159	Norwich Station and Trowse Lower Jn	All <u>Between Trains</u>	07 00 to 17 00. Construction work (overhead line), earthwork, track maintenance and signalling work. Points and signals disconnected. (86/7)
160	Thorpe Jn	All	08 00 to 17 00. Earthwork and track maintenance. (85/22)
161	Whitlingham Jn and Thorpe Jn	Up	07 30 to 17 00. Earthwork 1% and 1m.p. Mechanical equipment in use. (86/13)
162	Reedham Swing Bridge	Down and Up BLOCKED	08 00 to 16 00. Bridgework (No. 1238). <u>Possession to be given up for passage of trains.</u> (86/23)
163	Oulton Broad North Jn and Lowestoft	All	08 00 to 16 00. Undertrack excavation. 23 and 23% m.p. (86/26)

SECTION B - TEMPORARY ENGINEERING WORKS - continued

At or between	Lines affected	Remarks
<u>NORWICH TO LOWESTOFT - continued</u>		
<u>SATURDAY/SUNDAY 4/5 OCTOBER</u>		
164 Trowse Yard and Norwich	'C' line/Up Main BLOCKED Down Main/ 'W' line BLOCKED	22 00 to 16 00)Track renewal and signalling work. 23 55 to 06 45)Mechanical equipment in use. <u>23 55 Sat to</u> <u>06 45 Possession to</u> <u>be given up for passage</u> <u>of 1P04 02 10</u> <u>Liverpool Street to</u> <u>Yarmouth over Down</u> <u>Main/'W' line.</u> <u>06 45 to 16 00 Sun.</u> <u>Single line working</u> <u>over Down Main/'W'</u> <u>line.</u>

SUNDAY 5 OCTOBER

165 Norwich Station Platform 5 and Middle Siding	BLOCKED	06 00 to 15 00. Reballasting. Mechanical equipment in use. <u>Trains to be replatformed as necessary.</u>
--	---------	---

MONDAY 6 TO WEDNESDAY 8 OCTOBER

166 Trowse Yard and Norwich Station	All BLOCKED	23 15 Mon and Tue to 05 00 Tue and Wed. Track maintenance. Mechanical equipment in use. <u>Possession to be given up for passage of trains.</u>
-------------------------------------	----------------	---

WHITLINGHAM JN TO CROMERUNTIL FURTHER NOTICE

167 Whitlingham Jn and Wroxham	Down and Up	07 30 to 16 30. Bridgework (No. 365). 3m. 48chs. (86/6)
168 Cromer Station	Platforms 1 and 2	Platform work. (86/15)

SECTION B - TEMPORARY ENGINEERING WORKS - continued

<u>At or between</u>	<u>Lines affected</u>	<u>Remarks</u>
<u>CROMER TO SHERINGHAM</u>		
UNTIL FURTHER NOTICE		
169 Cromer Station	Platforms 1 and 2	Platform work. (86/15)
<u>BRUNDALL JN TO YARMOUTH VIA ACLE</u>		
UNTIL FURTHER NOTICE		
170 Lingwood	Single	08 00 to 17 00. Construction work. 8m. 03chs. (86/12)
<u>BETHNAL GREEN JN TO KING'S LYNN</u>		
UNTIL FURTHER NOTICE		
171 Cambridge Heath Station	Down and Up Suburban	08 00 to 17 00. Platform work. 1m. 6lchs. Mechanical equipment in use. (<u>See Section 'D'</u>). (86/24)
172 London Fields Station	Down and Up Suburban	Platform work. 2m. 35chs. Mechanical equipment in use. (<u>See Section 'D'</u>). (86/27)
173 Enfield Lock Station	Up	08 00 to 16 30. Platform work. 11m. 65chs. Mechanical equipment in use. <u>From 08 00 Monday 6 October.</u> (86/28)
174 Enfield Lock and Waltham Cross	Down and Up	07 00 to 18 00. Bridgework (No.1418C). 12m. 34chs. Crane and mechanical equipment in use. (85/59)
175 Bishops Stortford (Country end) and Stansted	Down and Up Main BLOCKED to electric trains	Overhead line work. <u>Isolation of electrical sections 427, 428 (buffer section).</u> (85/41)
176 Bishops Stortford and Cambridge (North)	All	07 00 to 18 00. Construction work (overhead line). Mechanical equipment in use. (85/21)

SECTION B - TEMPORARY ENGINEERING WORKS - continued

At or between	Lines affected	Remarks
---------------	----------------	---------

BETHNAL GREEN JN TO KING'S LYNN - continued

UNTIL FURTHER NOTICE - continued

177	Whittlesford Station	Down	Platform work 49m. 02chs. Mechanical equipment in use. (86/21)
178	Shelford	Down and Up	Platform work. 52m. 36chs. Mechanical equipment in use. (86/6)
179	Chesterton Jn and Milton Fen LC	Down and Up	07 30 to 18 00. Bridgework (No. 1550B). 58m. 63chs. Mechanical equipment in use. (86/24)
180	King's Lynn Harbour Jn and King's Lynn Jn	Single	08 00 to 19 00. Earthwork. 95m. 25chs. and 95m. 70chs. Mechanical equipment in use. <u>Until 19 00 Friday 10 October.</u> (86/27)
* FRIDAY/SATURDAY 3/4 OCTOBER			
181	Cheshunt Station and Brimsdown	Up Main BLOCKED	23 30 to 05 30. Track maintenance and unloading materials. Mechanical equipment in use. <u>Single line working over Down Main line.</u>

SATURDAY 4 OCTOBER

182	Bethnal Green and Clapton Jn	Down and Up Fast/ Down and Up BLOCKED to electric trains	00 45 to 04 45. In connection with overhead line work between Hackney Downs North Jn and Clapton Jn. <u>Isolation of electrical sections 407 and 408. Electric trains to travel over Suburban lines and to be diverted via Southbury.</u>
183	Hackney Downs North Jn and Clapton Jn	Down and Up BLOCKED	00 45 to 04 45. Overhead line work. Mechanical equipment in use. <u>Trains diverted via Southbury.</u>

SECTION B - TEMPORARY ENGINEERING WORKS - continued

At or between	Lines affected	Remarks
---------------	----------------	---------

BETHNAL GREEN JN TO KING'S LYNN - continued

SATURDAY/SUNDAY 4/5 OCTOBER

184	Bishops Stortford and Elsenham	Up Main	22 30 to 08 30)Construction work) (overhead line).)30% and 35% m.p.)Mechanical equipment in) use. Possession to be) given up for passage of) <u>1P04 02 10 Liverpool</u>) <u>Street to Yarmouth and</u>) <u>1H02 03 10 Liverpool</u>) <u>Street to King's Lynn</u>) <u>over Down Main line.</u>
		BLOCKED		
		Down Main	23 50 to 09 00	
		BLOCKED		
185	Elsenham and Great Chesterford	Up	22 30 to 08 15)Construction work) (overhead line))and trimming lineside)vegetation. 35% and)45% m.p. Mechanical)equipment in use.)Possession to be given)up for passage of <u>1P04</u>) <u>02 10 Liverpool Street</u>) <u>to Yarmouth and 1H02</u>) <u>03 10 Liverpool Street</u>) <u>to King's Lynn over</u>) <u>Down line.</u>
		BLOCKED		
		Down	23 50 to 09 00	
		BLOCKED		

SATURDAY 4 AND SUNDAY 5 OCTOBER

186	Cheshunt Jn and Bishops Stortford	All	06 00 to 17 00 daily.	Signalling work.
-----	---	-----	-----------------------	---------------------

SUNDAY 5 OCTOBER

187	Bethnal Green (Country End) and Hackney Downs	Down and Up Suburban BLOCKED	08 00 to 22 00.	Platform work (Cambridge Heath Station). Mechanical equipment in use. <u>Isolation of electrical sections</u> <u>313A, 314B. Trains to travel over</u> <u>Fast lines.</u>
-----	--	------------------------------------	-----------------	--

SECTION B - TEMPORARY ENGINEERING WORKS - continued

At or between	Lines affected	Remarks
<u>BETHNAL GREEN JN TO KING'S LYNN - continued</u>		
SUNDAY 5 OCTOBER - continued		
188 Clapton Jn and Cheshunt Jn	Down and Up Main BLOCKED to electric trains	00 01 to 23 59. In connection with engineering work between Tottenham South Jn and Cheshunt Jn. <u>Isolation of electrical sections 411 and 412. Electric trains diverted via Southbury.</u>
189 Cheshunt Station and Broxbourne	Down Main BLOCKED Up Main BLOCKED	00 10 to 08 15)Track maintenance,)reballasting, unloading 00 10 to 18 00)materials and overhead)line work. Mechanical)equipment in use.)00 10 to 08 15) <u>Isolation of electrical sections 413G, 414C.</u>) <u>Possession to be given up for passage of 1P04 02 10 Liverpool Street to Yarmouth, 1H02 03 10 Liverpool Street to King's Lynn and 1H04 04 00 Liverpool Street to Harlow Town over Down Main line. 08 15 to 18 00 Sun.)<u>Isolation of electrical sections 413G. Single line working over Down Main line.</u></u>
190 Shepreth Branch Jn and Coldham Lane Jn	All BLOCKED	00 30 to 08 00. Construction work (overhead line). 53½ and 56½m.p. Mechanical equipment in use. <u>Possession to be given up for passage of trains.</u>
191 Littleport	Down	08 00 to 12 00. Signalling work. <u>(See Section 'C').</u>

SECTION B - TEMPORARY ENGINEERING WORKS - continued

At or between	Lines affected	Remarks
<u>BETHNAL GREEN JN TO KING'S LYNN - continued</u>		
SUNDAY 5 TO MONDAY 6 OCTOBER		
192 Tottenham South Jn and Cheshunt Jn	Down Main BLOCKED Up Main BLOCKED	00 01 Sun to 01 00 Mon)Track)maintenance, 00 01 Sun to 04 00 Mon)formation)renewal and)platform work) (Enfield Lock) Station). Crane) and mechanical) equipment in) use. <u>00 01 Sun</u>) to <u>01 00 Mon.</u>) <u>Trains diverted</u>) <u>via Southbury.</u>) <u>01 00 to 04 00</u>) <u>Mon. Up trains</u>) <u>diverted via</u>) <u>Southbury.</u>

SUNDAY/MONDAY 5/6 OCTOBER

193 Waterbeach and Chesterton Jn	Up BLOCKED	22 30 to 05 30. Track maintenance. 58m. 3lchs. and 57 $\frac{3}{4}$ m.p. Mechanical equipment in use. <u>Single line</u> <u>working over Down line.</u>
--	---------------	--

MONDAY 6 OCTOBER

194 Bethnal Green (Country End) and Chingford	Down and Up Fast/ Down and Up BLOCKED to electric trains	00 55 to 04 00. In connection with overhead line work between Hackney Downs and Chingford. <u>Isolation</u> <u>of electrical sections 407, 408, 409</u> <u>and 410. Electric trains to travel</u> <u>over Suburban lines.</u>
195 Hackney Downs and Chingford	Down and Up Fast/ Down and Up BLOCKED	00 55 to 04 00. Overhead line work. <u>Trains to travel over Suburban lines.</u>

MONDAY 6 AND TUESDAY 7 OCTOBER

196 Stansted and Elsenham	Down Main and Down Goods Loop BLOCKED	09 20 to 15 15 daily. Construction work (overhead line). 33 $\frac{1}{2}$ and 35 $\frac{1}{2}$ m.p. <u>Single line working over Up Main line.</u>
------------------------------	---	---

SECTION B - TEMPORARY ENGINEERING WORKS - continued

At or between	Lines affected	Remarks
---------------	----------------	---------

BETHNAL GREEN JN TO KING'S LYNN - continued

MONDAY 6 TO FRIDAY 10 OCTOBER

197	Shepreth Branch Jn and Coldham Lane Jn	All <u>Between Trains</u>	08 00 to 16 00 daily. Construction work (overhead line). 53½ and 56¾m.p. Mechanical equipment in use.
198	Cambridge (North) and Coldham Lane Jn	Down Goods Loop North BLOCKED Down Main	08 00 to 16 00 daily. Earthwork. 56 and 56¾m.p. Mechanical equipment in use.

TUESDAY 7 OCTOBER

199	Broxbourne and Cheshunt Station	Up Main BLOCKED	00 01 to 04 15. Track maintenance. Mechanical equipment in use. <u>Single line working over Down Main line.</u>
200	Waterbeach and Chesterton Jn	Up BLOCKED	00 40 to 05 30. Track maintenance 58m. 3lchs. and 57¾m.p. Mechanical equipment in use. <u>Single line working over Down line.</u>

TUESDAY 7 TO FRIDAY 10 OCTOBER

201	Bethnal Green (Country End) and Bury Street Jn	Down and Up Suburban/ Down and Up BLOCKED to electric trains	00 45 to 05 00 daily. In connection with overhead line work between Hackney Downs North Jn and Seven Sisters. <u>Isolation of electrical sections 401 and 402. Electric trains to travel over Fast lines and to be diverted via Clapton.</u>
-----	--	--	--

WEDNESDAY 8 TO FRIDAY 10 OCTOBER

202	Bishops Stortford and Stansted	Down Main BLOCKED	09 20 to 15 00 daily. Construction work (overhead line). 30¾ and 33¾m.p. <u>Single line working over Up Main line.</u>
-----	--------------------------------	----------------------	--

THURSDAY/FRIDAY 9/10 OCTOBER

203	Harlow Mill and Spelbrook	Down BLOCKED	23 15 to 04 40. Track maintenance. Mechanical equipment in use. <u>Single line working over Up line.</u>
-----	---------------------------	-----------------	--

SECTION B - TEMPORARY ENGINEERING WORKS - continued

At or between	Lines affected	Remarks
<u>READING LANE JN TO NAVARINO ROAD JN (GRAHAM ROAD CURVE)</u>		
SUNDAY 5 OCTOBER		
204 Reading Lane Jn and Navarino Road Jn	Single BLOCKED to electric trains	08 00 to 22 00. In connection with engineering work between Bethnal Green and Hackney Downs. <u>Isolation of electrical sections 314C.</u>

HACKNEY DOWNS NORTH JN TO ENFIELD TOWN

TUESDAY 7 TO FRIDAY 10 OCTOBER

205 Bethnal Green (Country End) and Bury Street Jn	Down and Up Suburban/ Down and Up BLOCKED to electric trains	00 45 to 05 00 daily. In connection with overhead line work between Hackney Downs North Jn and Seven Sisters. <u>Isolation of electrical sections 401 and 402. Electric trains to travel over Fast lines and to be diverted via Clapton.</u>
206 Hackney Downs North Jn and Seven Sisters	Down and Up BLOCKED	00 45 to 05 00 daily. Overhead line work. Mechanical equipment in use. <u>Trains diverted via Clapton.</u>

BURY STREET JN TO CHESHUNT

SATURDAY 4 AND SUNDAY 5 OCTOBER

207 Bury Street Jn and Cheshunt Jn	Down and Up	06 00 to 17 00 daily. Signalling work.
------------------------------------	-------------	--

CLAPTON JN TO CHINGFORD

SUNDAY 5 OCTOBER

208 Chingford	All	08 00 to 17 00. Signalling work.
---------------	-----	----------------------------------

MONDAY 6 OCTOBER

209 Bethnal Green (Country End) and Chingford	Down and Up Fast/ Down and Up BLOCKED to electric trains	00 55 to 04 00. In connection with overhead line work between Hackney Downs and Chingford. <u>Isolation of electrical sections 407, 408, 409 and 410. Electric trains to travel over Suburban lines.</u>
---	---	--

SECTION B - TEMPORARY ENGINEERING WORKS - continued

At or between	Lines affected	Remarks
---------------	----------------	---------

CLAPTON JN TO CHINGFORD - continued

MONDAY 6 OCTOBER - continued

210 Hackney Downs and Chingford	Down and Up Fast/ Down and Up BLOCKED	00 55 to 04 00. Overhead line work. <u>Trains to travel over Suburban lines.</u>
------------------------------------	---	---

BROXBOURNE JN TO HERTFORD EAST

UNTIL FURTHER NOTICE

211 Rye House and St. Margarets	Down and Up	08 00 to 18 00. Bridgework (No. 2035A). 19m. 66chs. Mechanical equipment in use. (85/60)
------------------------------------	-------------	---

SUNDAY 5 OCTOBER

212 Broxbourne Jn and Hertford East	All BLOCKED	00 30 to 06 30. Platform work and construction work (St. Margarets Station). Mechanical equipment in use. <u>Isolation of electrical sections 434 and 435.</u>
---	----------------	---

* TUESDAY 7 TO FRIDAY 10 OCTOBER

213 Broxbourne Jn and Hertford East	All BLOCKED	00 35 to 04 50 daily. Platform work and construction work (St. Margarets Station) Mechanical equipment in use. <u>Isolation of electrical sections 434 and 435.</u>
---	----------------	--

COLDHAM LANE JN TO HAUGHLEY JN

UNTIL FURTHER NOTICE

214 Bury St. Edmunds Station	Down	08 00 to 15 00. Repairs to platform awnings. (86/18)
215 Bury St. Edmunds and Elmswell	Down and Up	08 00 to 18 00. Drainage 29m. 78chs. Mechanical equipment in use. (86/12)

SECTION B - TEMPORARY ENGINEERING WORKS - continued

<u>At or between</u>	<u>Lines affected</u>	<u>Remarks</u>
----------------------	-----------------------	----------------

COLDHAM LANE JN TO HAUGHLEY JN - continued

SATURDAY/SUNDAY 4/5 OCTOBER

216	Bury St. Edmunds and Haughley Jn	Up BLOCKED Down BLOCKED	22 00 to 13 15)Demolition work, track)maintenance and 23 15 to 16 00)reballasting.)Mechanical equipment)in use. <u>13 15 to</u>) <u>16 00 Sun Single line</u>) <u>working over Up line.</u>
-----	--	----------------------------------	--

THURSDAY/FRIDAY 9/10 OCTOBER

217	Kennett and Bury St. Edmunds	Down BLOCKED	23 00 to 05 30. Track maintenance. Mechanical equipment in use. <u>Single</u> <u>line working over Up line.</u>
-----	------------------------------------	-----------------	---

ELY NORTH JN TO PETERBOROUGH, CRESCENT JN

TUESDAY 7 TO FRIDAY 10 OCTOBER

218	Manea and March South Jn	Down BLOCKED	23 20 Tue to Thu to 04 10 Wed to Fri. Track maintenance. 81 and 82 $\frac{1}{2}$ m.p. <u>Single line working over Up line.</u>
-----	-----------------------------	-----------------	--

ELY NORTH JN TO TROWSE LOWER JN

UNTIL FURTHER NOTICE

219	Thetford and Lakenheath	Up	08 00 to 16 00. Track maintenance. 87 $\frac{1}{2}$ and 85 $\frac{1}{2}$ m.p. (86/24)
220	Wymondham and Hethersett	Down and Up <u>Between Trains</u>	07 30 to 18 00. Bridgework, earthwork and construction work. 115m. 65chs. and 117m. 69chs. Cranes and mechanical equipment in use. (86/18)
221	Wymondham and Trowse Lower Jn	Down and Up	07 30 to 16 00. Signalling work. (85/24)
222	Hethersett and Trowse Lower Jn	Down and Up	07 30 to 16 00. Bridgework (Nos.1638, 1640, 1640A and 349). 121m. 17chs. and 122m. 32chs. (86/22)

SECTION B - TEMPORARY ENGINEERING WORKS - continued

At or between	Lines affected	Remarks
---------------	----------------	---------

ELY NORTH JN TO TROWSE LOWER JN - continued

SATURDAY/SUNDAY 4/5 OCTOBER

223	Lakenheath and Brandon	Down and Up BLOCKED	23 30 to 07 30. Loading materials. 85% and 86% m.p. Mechanical equipment in use. <u>Possession to be given up for passage of trains.</u>
224	Hethersett and Trowse Lower Jn	Up BLOCKED Down BLOCKED	23 00 to 07 15) Bridgework (Nos. 1640 and 1640A). 121% m.p. 23 00 to 16 00) Crane and mechanical equipment in use. 23 00 Sat to 07 15. <u>Possession to be given up for passage at 1P04</u> <u>02 10 Liverpool Street to Yarmouth over Up line under single line working.</u> <u>07 15 to 16 00 Sun.</u> <u>Single line working over Up line.</u>

MONDAY 6 TO SATURDAY 11 OCTOBER

*225	Wymondham and Trowse Lower Jn	Down and Up BLOCKED	23 00 Mon to Fri to 06 00 Tue to Sat. Bridgework (No. 1628A). Crane and mechanical equipment in use.
------	-------------------------------	------------------------	--

TUESDAY/WEDNESDAY 7/8 OCTOBER

226	Brandon and Thetford	Down and Up BLOCKED	23 45 to 05 45. Track maintenance. Mechanical equipment in use.
-----	----------------------	------------------------	---

THURSDAY 9 OCTOBER

227	Lakenheath and Brandon	Down and Up	08 30 to 15 00. Work on overhead power cables (EEB). 84% m.p. and 84m. 50chs.
-----	------------------------	-------------	---

SECTION B - TEMPORARY ENGINEERING WORKS - continued

At or between	Lines affected	Remarks
<u>WYMONDHAM TO NORTH ELMHAM</u>		
UNTIL FURTHER NOTICE		
228 Wymondham and North Elmham	Single	08 00 to 16 00. Trimming lineside vegetation. $\frac{1}{2}$ and 6m.p. Mechanical equipment in use. (85/31)
<u>FENCHURCH STREET TO SHOEBURYNES</u>		
UNTIL FURTHER NOTICE		
229 Fenchurch Street Station	All	Construction/demolition work. Mechanical equipment in use. (84/38)
230 Fenchurch Street and Stepney East	All	Construction work, and in connection with engineering work (Docklands Light Railway). Mechanical equipment in use. <u>(See Section 'D')</u> . (86/25)
231 Fenchurch Street and Gas Factory Jn	All	08 00 to 17 00. Signalling work. (86/1)
232 East Ham	Down and Up	Construction work. Mechanical equipment in use. (83/51)
233 East Ham and Barking (London End)	Down and Up	Erecting scaffolding in connection with bridge No. 66B. (85/8)
234 Leigh-on-Sea and Benfleet	Up	Sea wall work. (85/34)
235 Leigh-on-Sea	Down	09 00 to 16 00. Demolition work. Mechanical equipment in use. (85/60)
236 Westcliff-on-Sea	Down	09 00 to 16 00. Demolition work. Mechanical equipment in use. (85/60)

SECTION B - TEMPORARY ENGINEERING WORKS - continued

At or between	Lines affected	Remarks
<u>FENCHURCH STREET TO SHOEBURYNESSE - continued</u>		
FRIDAY/SATURDAY 3/4 OCTOBER		
237 Fenchurch Street	All BLOCKED	21 15 to 06 00. Construction work. Mechanical equipment in use.
238 Fenchurch Street and Gas Factory Jn	All BLOCKED	21 15 to 06 00. Repairs to platform awnings (Stepney East Station), construction work and painting Stepney East Station. <u>Isolation of electrical sections 501, 502, 503 and 504.</u>
239 East Ham (London End) and Barking Station (London End)	Down and Up BLOCKED	21 15 to 05 15. Overhead line work and bridgework (No. 66B). Crane and mechanical equipment in use. <u>Isolation of electrical sections 510A, 511E.</u>
SATURDAY 4 OCTOBER		
240 Barking Station (Country End) and Forest Gate Jn	Up Tilbury/Up and Up Goods Loop BLOCKED to electric trains	01 00 to 04 00. In connection with engineering work at Barking. <u>Isolation of electrical sections 513.</u>
241 Barking	Platform 8 (Up Tilbury) BLOCKED	01 00 to 04 00. Bridgework (No. 20). <u>Up Diesel trains to travel over No. 9 Road (Up Goods Loop).</u>
SUNDAY 5 OCTOBER		
242 East Ham (London End) and Barking Station (Country End)	Down and Up Main BLOCKED	01 30 to 04 45. Bridgework (No.66B). Crane and mechanical equipment in use. <u>Isolation of electrical sections 510A, 511E.</u>
243 Barking	Platforms 7 and 8 (Down and Up Tilbury) BLOCKED Platforms 4 and 5 (Down and Up Main) BLOCKED	00 50 to 06 15)Track maintenance.)Mechanical equipment)in use. <u>Possession to be given up for</u>) <u>passage of Engineers'</u> 01 10 to 05 30) <u>trains over No.7</u>) <u>Platform (Down</u>) <u>Tilbury) line.</u>))

SECTION B - TEMPORARY ENGINEERING WORKS - continued

At or between	Lines affected	Remarks	
<u>FENCHURCH STREET TO SHOEburyNESS - continued</u>			
SUNDAY 5 OCTOBER - continued			
244	Laindon (Country End) and Upminster	Up Main BLOCKED	01 00 to 06 00. Track maintenance 22m. 65chs. and 22m. 54chs.
245	Laindon and Leigh-on-Sea	Down and Up BLOCKED	01 25 to 19 00. Track maintenance, track renewal, overhead line work and undertrack excavation. Mechanical equipment in use. <u>Isolation of electrical sections 519A, 520C, 521E, 522A.</u>
MONDAY 6 OCTOBER			
246	Barking	Platform 5 (Up Main) BLOCKED	10 00 to 13 00. Bridgework (No. 20). <u>Isolation of electrical sections 511C.</u> <u>Up trains to travel over No. 8 Platform (Up Tilbury) line.</u>
247	Pitsea and Leigh-on-Sea	Down and Up BLOCKED	01 35 to 04 25. Overhead line work. <u>Isolation of electrical sections 521AB, 522CDE, 523B, 524A.</u>
MONDAY 6 TO SATURDAY 11 OCTOBER			
248	Fenchurch Street	All BLOCKED	21 15 Mon to Fri to 06 00 Tue to Sat. Construction work. Mechanical equipment in use.
249	Fenchurch Street and Gas Factory Jn.	All BLOCKED	21 15 Mon to Fri to 06 00 Tue to Sat. Repairs to platform awnings (Stepney East Station), construction work and painting Stepney East Station. <u>Isolation of electrical sections 501, 502, 503 and 504.</u>
250	East Ham (London End) and Barking Station (Country End)	Down and Up Main BLOCKED	21 15 Mon to Fri to 05 15 Tue to Sat. Bridgework (No. 66B). Crane and mechanical equipment in use. <u>Isolation of electrical sections 510A, 511E.</u>

SECTION B - TEMPORARY ENGINEERING WORKS - continued

<u>At or between</u>	<u>Lines affected</u>	<u>Remarks</u>
----------------------	-----------------------	----------------

FENCHURCH STREET TO SHOEBURYNESS - continued

TUESDAY 7 OCTOBER

251 Pitsea and Leigh-on-Sea	Down BLOCKED	01 30 to 05 00. Track maintenance. Mechanical equipment in use. <u>Single line working over Up line.</u>
-----------------------------	-----------------	--

TUESDAY 7 TO FRIDAY 10 OCTOBER

252 Upminster and Pitsea	Down and Up BLOCKED	01 15 to 03 55 daily. Overhead line work. Mechanical equipment in use. <u>Isolation of electrical sections 517, 518, 519 and 520. Trains diverted via Grays.</u>
--------------------------	------------------------	--

FRIDAY 10 OCTOBER

253 Leigh-on-Sea and Pitsea	Up BLOCKED	01 00 to 04 30. Track maintenance. Mechanical equipment in use. <u>Single line working over Down line.</u>
-----------------------------	---------------	--

UPPER HOLLOWAY TO BARKING, TILBURY LINE JN WEST

UNTIL FURTHER NOTICE

254 Upper Holloway and Crouch Hill Station	Down and Up	Earthwork. 3m 41chs. and 3m 43chs. Mechanical equipment in use. (85/64)
255 Wanstead Park Station	Up	08 00 to 16 00. Platform work. <u>(See Section 'D')</u> . (85/50)
256 Woodgrange Park and Barking Station Jn	Down and Up <u>Between Trains</u>	07 30 to 18 00. Bridgework (No. 6). 12m. 26chs. Crane and mechanical equipment in use. (85/62)
257 Woodgrange Park and Barking Tilbury Line Jn West	Down and Up	Erecting scaffolding in connection with bridge No. 14A. (85/8)

SECTION B - TEMPORARY ENGINEERING WORKS - continued

<u>At or between</u>	<u>Lines affected</u>	<u>Remarks</u>
----------------------	-----------------------	----------------

UPPER HOLLOWAY TO BARKING, TILBURY LINE JN WEST - continued

SATURDAY 4 OCTOBER

258 Barking Station (Country End) and Forest Gate Jn	Up Tilbury/Up and Up Goods Loop BLOCKED to electric trains	01 00 to 04 00. In connection with engineering work at Barking. <u>Isolation of electrical sections 513.</u>
--	---	---

SUNDAY 5 TO MONDAY 6 OCTOBER

259 Forest Gate Jn and Barking Tilbury Line Jn West	All BLOCKED to electric trains	00 50 Sun to 04 00 Mon. In connection with engineering work between Woodgrange Park Jn and Barking Tilbury Line Jn West. <u>Isolation of electrical sections 512 and 513.</u>
260 Woodgrange Park Jn and Barking Tilbury Line Jn West	Down and Up BLOCKED	00 50 Sun to 04 00 Mon. Bridgework (No.14A) and unloading materials. Crane and mechanical equipment in use. <u>Possession to be given up for passage of Diesel trains.</u>

BARKING, TILBURY LINE JN EAST TO TILBURY RIVERSIDE

UNTIL FURTHER NOTICE

261 Dagenham Dock Station	Down and Up	08 00 to 17 00. Construction work. Mechanical equipment in use. (85/14)
262 Rainham Station	Down and Up	08 00 to 17 00. Construction work. Mechanical equipment in use. (85/14)
263 Purfleet Station	Down and Up	09 00 to 16 00. Platform work. Mechanical equipment in use. (85/61)

SECTION B - TEMPORARY ENGINEERING WORKS - continued

At or between	Lines affected	Remarks
---------------	-------------------	---------

BARKING, TILBURY LINE JN EAST TO TILBURY RIVERSIDE - continued

SUNDAY 5 OCTOBER

264 Barking Tilbury All Line Jn East and West Thurrock Jn.	BLOCKED	00 35 to 07 00. Track maintenance. Mechanical equipment in use.
--	---------	--

MONDAY 6 TO WEDNESDAY 8 OCTOBER

265 Purfleet and West Thurrock Jn	Down BLOCKED	23 30 Mon and Tue to 05 00 Tue and Wed. Track maintenance. <u>Single</u> <u>line working over Up line.</u>
---	-----------------	--

SECTION CSIGNALLING AND PERMANENT WAY ALTERATIONS

* * Items marked thus will not appear in future issues and a note must be
* taken of them by all concerned.

DETAILS OF WORK REFERRED TO IN SECTION BSUNDAY 5 OCTOBER - DISS-TIVETSHALL-SWAINSTHORPE

Diss and Tivetshall Signalboxes will be abolished and new colourlight signalling will be commissioned. Full details are published in Supplementary Signalling Notice No. 145 and all concerned should be in possession of a copy of this Notice.
(31)

SUNDAY 5 OCTOBER - LITTLEPORT

The Down Distant signal No. 25 will be replaced No. 24R.
(31)

MONDAY 6 OCTOBER - TEMPLE MILLS YARD

Manor Sidings, and Fans A and B, together with all associated switches and crossings (excluding any running line connections), will be secured out of use pending removal.
(31)

MONDAY 6 OCTOBER - BETWEEN READING LANE JN AND NAVARINO ROAD JN

A 10 m.p.h. Permanent Speed Restriction, applicable to Down trains only, will be IMPOSED on the SINGLE line between 2m 55chs (Reading Lane Jn - including through Reading Lane Jn) and 2m 71chs.

The Maximum Permissible Speed, applicable to DOWN trains over the remaining portion of the SINGLE line between 2m 71chs and Navarino Road Jn will be INCREASED to 30 m.p.h. (See Section 'D').
(31)

DETAILS OF WORK ALREADY CARRIED OUTNEW HALL

The Up Loop has been taken out of use Until Further Notice.
(UFN)

SECTION C - SIGNALLING AND PERMANENT WAY ALTERATIONS - continuedDETAILS OF WORK ALREADY CARRIED OUT - continuedHATFIELD PEVEREL

The facing and trailing crossovers are out of use until further notice.
(UFN)

GISSING LEVEL CROSSING AT 98m 57chs (between Diss and Tivetshall

The level crossing gates have been removed and the crossing converted to one with automatic half-barriers.

Telephone communication has been provided between the crossing and Diss signalbox (previously to Tivetshall).

Working in wrong direction

The barriers have been equipped to work automatically when approached in the reverse direction and for this purpose a combined St. Andrew's Cross/50 m.p.h. speed restriction sign has been provided 954 yards from the crossing applicable to each rail approach in the wrong direction.

(29)

NEWTON FLOTMAN LEVEL CROSSING AT 108m. 19chs. (between Tivetshall and Swainsthorpe)

The level crossing gates have been removed and the crossing converted to one with Automatic half-barriers.

The crossing will be closed to road traffic and the barriers secured in the lowered position until the associated road works are completed when the barriers will be fully commissioned.

Telephone communication has been provided between the level crossing and Swainsthorpe signalbox.

Working in wrong direction

The automatic half-barriers have been equipped to work automatically when approached in the wrong direction, and for this purpose a combined St. Andrews Cross/50 m.p.h. speed restriction sign has been provided 1,003 yards from the crossing applicable to each rail approach in the wrong direction.

(29)

TIVETSHALL

The trailing crossover has been secured out of use pending removal and the associated shunting signals abolished.

(30)

SECTION C - SIGNALLING AND PERMANENT WAY ALTERATIONS - continuedDETAILS OF WORK ALREADY CARRIED OUT - continuedTROWSE UPPER JUNCTION AND TROWSE LOWER JUNCTIONTrowse Upper Junction

Trowse Upper Junction Signal Box, together with all signals worked therefrom has been abolished. All points previously worked therefrom including the Siding line to Victoria Goods Depot have been secured out of use pending removal.

(The catch points are unaffected at this stage).

The Block Section is now between Swainsthorpe and Trowse Lower Junction.

Trowse Lower JunctionSignalling Alterations

A new Trowse Lower Junction Down Main Distant plated TL47 (3-aspect colour light signal exhibiting Yellow or Green aspect only at this stage) has been provided 1,500 yards before reaching the Trowse Lower Junction Down Home signal TL45. (This new Distant signal is 700 yards further from TL45 signal than was the former Trowse Upper Junction Down Main Starting signal TU20 which incorporated the Trowse Lower Junction Down Distant).

An Automatic Warning System track inductor has been provided in conjunction with TL47 new colour light Distant signal.

(29)

TROWSE SWING BRIDGE

The following points have been secured out of use pending removal :-

Trailing Crossover between the Down and Up Main Lines.

Facing connection - Down Main to the Temporary Goods Single Line to Crown Point and Whitlingham Junction (Reinstated Wensum Curve Single Line).

All associated ground shunting signals have been abolished.

The temporary Goods Single Line has been taken out of use and has reverted to being the Crown Point Depot "Dead End" Siding No.1A. A temporary Stop-Block has been provided adjacent to the site of the former permanent red colour light signal TSB3 which has also been abolished.

(30)

THORPE JUNCTION

A new Engine Neck Siding has been brought into use adjacent to and connected to Line 'A/E' via new points giving access at the Norwich Station end.

SECTION C - SIGNALLING AND PERMANENT WAY ALTERATIONS - continuedDETAILS OF WORK ALREADY CARRIED OUT - continuedTHORPE JUNCTION - continued

The new Siding line is located between Carrow Road Bridge and the Up/Down Lowestoft Line Crossovers, and provides standage for stabling up to the equivalent of two main line locomotives (approximately 50 yards standage).

A new "Exit" position light shunting signal plated NO 1779 has been provided at the trap points of the new Engine Neck Siding and a 2-way stencil-type route indicator has been provided. A telephone communicating with Norwich Station signal box has been provided adjacent to NO 1779 signal.

Additional routes on existing signals

The existing signals now applying towards the new Engine Neck Siding and the route indications on new NO 1779 Signal are included in the Description of Signals below.

Main Signals

<u>Line</u>	<u>Signal</u>	<u>Aspect</u> (PL = Position Light)	<u>Route</u> <u>Indication</u>	<u>Application</u> <u>Towards</u>
Platforms 1, 2, 3, 4, 5, 6	NO 574/576 578/580/584 586	PL	'N'	Engine Neck Sidings.
Jubilee Siding	NO 588	PL	'N'	"

Position Light Signals

Middle Siding	NO 1792		'N'	"
Engine Neck Siding	NO 1779		'C'	Line C, Signal No. 1785.
			'E'	Line E Signal No. 1787. (30)

THORPE JUNCTION



Line 'A'/'E' has been realigned nearer to Line 'B', between Carrow Road Bridge and the Up/Down Lowestoft lines crossovers at Thorpe Junction. The associated redundant trap points and sand-drag have been removed.

SECTION C - SIGNALLING AND PERMANENT WAY ALTERATIONS - continuedDETAILS OF WORK ALREADY CARRIED OUT - continuedWESTERFIELD

The notice board at the Lowestoft end of the Down Platform worded, "STOP - OBTAIN TOKEN AND PERMISSION TO PROCEED", has been repositioned 15 yards nearer to the signal box.

(30)

UFFORD LEVEL CROSSING AT 81M. 6OCHS. (East Suffolk Line)

The combined St. Andrews Cross/speed restrictions sign  on the Up approach to Ufford level crossing has been replaced by an  sign 476 yards before reaching the crossing.

(29)

TRIMLEY

The Up Passenger Platform Loop has been taken out of use and the Down Platform line has become the Single Line (Up/Down Platform).

The points at each end of the Loop have been secured out of use in the normal position for through running along the Single line. (The points at the Felixstowe end of the Loop have been secured out of use pending removal).

Signalling Alterations

The Up Platform Loop Starting Signal is now applicable to the Single line.

The Up Single line Home Signal now applies along the Single line towards the Up/Down Platform.

(30)

CAMBRIDGE - COLDHAM LANE DEPOT CARRIAGE SIDINGS

New trap points have been brought into use at the North end of No. 4 Carriage Siding at 56 $\frac{1}{2}$ mp in Coldham Lane Depot.

The new trap points and the adjacent spring points connecting No.4 Carriage Siding to Nos. 4 and 5 Diesel Sidings are now operated from a new single-lever ground frame, the normal position of which sets the former spring points in Nos. 4 and 5 Diesel Sidings towards Coldham Lane Depot exit line Position Light Signal No.740 and the new trap points in the open trap position.

The ground frame lever is maintained locked in the normal position by a padlock, the key to which is held by the Carriage Sidings/Yard Supervisor. Telephone communication has been provided between the new ground frame and Cambridge Signalbox.

SECTION C - SIGNALLING AND PERMANENT WAY ALTERATIONS - continuedDETAILS OF WORK ALREADY CARRIED OUT - continuedCAMBRIDGE - COLDHAM LANE DEPOT CARRIAGE SIDINGS - continued

The "STOP TELEPHONE" notice board at the North end of No.4 Carriage Siding and the associated telephone have been abolished. A new notice board worded "STOP FOR ORDERS" has been provided immediately South of the new trap points in No.4 Carriage Siding.

(30)

* * SNAILWELL (Between Chippenham Junction and Soham)

*

A new trailing connection has been brought into use in the Up line at 3m.p. leading to Firmin Coates Private Siding.

Operation is by two-lever ground frame released from Chippenham Junction signalbox. (Telephone communication has been provided between the ground frame and signalbox).

(28)

FOBBING LEVEL CROSSING 30m 34chs (between Stanford-le-Hope and Pitsea)

The crossing has been converted to automatic half-barriers. Fobbing Gate Box has been abolished.

Telecommunication has been provided between the crossing and Pitsea Signalbox.

Alterations to signalling ('PJ' denotes prefix of Pitsea Signalbox)

Down Tilbury

Semi-automatic signal F3 (level crossing protecting signal) and its associated A.W.S. equipment has been abolished.

PJ22 automatic signal (on the approach to F3) now displays Red or Green aspect only.

Up Tilbury

Level crossing protecting signal F2 now displays Yellow or Green aspect only and functions as Up Distant. This signal has been replated PJ27R. (The semi-auto plate has been removed).

Signal PJ23 (on the approach side of PJ27R signal, former F2) now displays Red or Green aspect only.

(30)

SECTION D

GENERAL INSTRUCTIONS AND NOTICES

A thick vertical line denotes new or amended items.

* * Items marked thus will not appear in future issues and a note must be taken of them by all concerned.
*

EASTERN REGION SECTIONAL APPENDIX (SOUTHERN AREA)

TABLE A : DETAILS OF RUNNING LINES

Running Lines and Signalling System	Location	M. Ch.	Permanent Speed Restrictions		Remarks
			Down m.p.h.	Up m.p.h.	
<u>LIVERPOOL STREET TO NORWICH</u> Page 57 (Page At Colchester (CO) <u>Amend</u> 'Remarks' column entry to read:-	, SD PON)				Colchester (CO) signal box area between Colchester and Flordon.

SE-50

SECTION D - GENERAL INSTRUCTIONS AND NOTICES - continued

EASTERN REGION SECTIONAL APPENDIX (SOUTHERN AREA) - continued

Running Lines and Signalling System	Location	M. Ch.	Permanent Speed Restrictions		Remarks
			Down m.p.h.	Up m.p.h.	
<u>LIVERPOOL STREET TO NORWICH - continued</u>					
Page 60 (Page	, SD PON)				
At Haughley LC (AHB)					
Amend 'Remarks' column entry to read:-					Telephones to Colchester signal box are provided at all 2 aspect distant signals between 82 1/2 m.p. and 90 m.p.
Pages 60 and 61 (Page	, SD PON)				
Delete all details between Mellis LC (AHB-X) and Swainsthorpe and substitute:-					
▲ ▼	Mellis LC (AHB-X)	91 34	X50	X50	<u>Approaching level crossing in wrong direction.</u>
					Telephone to Colchester signal box at 92m. 77chs. (Signal CO 424R).

SE-51

SECTION D - GENERAL INSTRUCTIONS AND NOTICES - continued

EASTERN REGION SECTIONAL APPENDIX (SOUTHERN AREA) - continued

Running Lines and Signalling System	Location	M. Ch.	Permanent Speed Restrictions		Remarks
			Down m.p.h.	Up m.p.h.	
<p><u>LIVERPOOL STREET TO NORWICH - continued</u></p> <p>Pages 60 and 61 (Page , SD PON) - continued:-</p> <p><u>Delete</u> all details between Mellis LC (AHB-X) and Swainsthorpe and <u>substitute</u> - continued:-</p>					
	Palgrave LC (AHB-X)	94 04	X50	X50	<u>Approaching level crossing in wrong direction.</u>
	Diss	94 79			
	Audley End (Norfolk) LC (AHB-X)	97 05	X50	X50	<u>Approaching level crossing in wrong direction.</u>
	Burston LC (AHB-X)	97 42	X50	X50	<u>Approaching level crossing in wrong direction.</u>

SE-52

SECTION D - GENERAL INSTRUCTIONS AND NOTICES - continued

EASTERN REGION SECTIONAL APPENDIX (SOUTHERN AREA) - continued

Running Lines and Signalling System	Location	M. Ch.	Permanent Speed Restrictions		At or Between	Remarks
			Down m.p.h.	Up m.p.h.		
<u>LIVERPOOL STREET TO NORWICH - continued</u>						
Pages 60 and 61 (Page , SD PON) - continued:-						
<u>Delete</u> all details between Mellis LC (AHB-X) and Swainsthorpe and <u>substitute</u> - continued:-						
▲ ▼	Gissing LC (AHB-X)	98 57	X50	X50	<u>Approaching level crossing in wrong direction.</u>	Telephones to Colchester signal box at 104m. 41chs. (Signal CO 448R) and at 105m. 19chs. (Signal CO 453R).
	Hales Street LC (AHB-X)	100 27	X50	X50	<u>Approaching level crossing in wrong direction.</u>	
	Tivetshall LC (AHB-X)	100 43	X50	X50	<u>Approaching level crossing in wrong direction.</u>	
	Moulton LC (AHB-X)	101 51	X50	X50	<u>Approaching level crossing in wrong direction.</u>	
	Flordon	106 63				

SECTION D - GENERAL INSTRUCTIONS AND NOTICES - continued

EASTERN REGION SECTIONAL APPENDIX (SOUTHERN AREA) - continued

Running Lines and Signalling System	Location	M. Ch.	Permanent Speed Restrictions		Remarks
			Down m.p.h.	Up m.p.h.	
<u>LIVERPOOL STREET TO NORWICH - continued</u>					
Pages 60 and 61 (Page , SD PON) - continued:-					
<u>Delete</u> all details between Mellis LC (AHB-X) and Swainsthorpe and <u>substitute</u> - continued:-					
	Newton Flotman LC (AHB-X)	108 19	X50	X50	<u>Approaching level crossing in wrong direction.</u>
	Swainsthorpe LC	109 54			<u>(w.e.f. Sunday 5 October). (12.SD)</u>
<u>BETHNAL GREEN JN TO KING'S LYNN</u>					
Page 82 (Page , SD PON)					
At Reading Lane Jn					
<u>Amend</u> :-					
			10		<u>To Graham Road Curve line.</u> <u>(w.e.f. Monday 6 October). (12.SD)</u>

SE-54

SECTION D - GENERAL INSTRUCTIONS AND NOTICES - continued

EASTERN REGION SECTIONAL APPENDIX (SOUTHERN AREA) - continued

Running Lines and Signalling System	Location	M. Ch.	Permanent Speed Restrictions		Remarks
			Down m.p.h.	Up m.p.h.	
<u>READING LANE JN TO NAVARINO ROAD JN (GRAHAM ROAD CURVE)</u>					
Page 88 (Page , SD PON)					
Delete all details and substitute:-			30	30	MAXIMUM PERMISSIBLE SPEED
	Reading Lane Jn (See page 82)	2 55	10		<u>2m. 55chs. and 2m. 71chs.</u>
	Navarino Road Jn (See page 63)	2 79			
					(w.e.f. Monday 6 October). (12.SD)
Page 111					
<u>TILBURY RIVERSIDE TO PITSEA</u>					
Amend:-	Fobbing LC (AHB)	30 34			(12.SD)

SE-55

SECTION D - GENERAL INSTRUCTIONS AND NOTICES - continuedEASTERN REGION SECTION APPENDIX (SOUTHERN AREA) - continuedOTHER GENERAL INSTRUCTIONS

Page 297 (Page , SD PON)

DOCKLANDS LIGHT RAILWAY LINE BETWEEN BOW JN AND STRATFORD STATION
(ADJACENT TO THE B.R. UP ELECTRIC LINE)

Amend end of first paragraph to read:-

, except that reference to Electrical Control Operator should be read as Controller and Supervisor at Poplar Control Centre, who can be contacted via the Signaller at Bow Jn or Stratford or the Electrical Control Operator at Romford or on British Telecom 538 3440.

(12.SD)

MISCELLANEOUS NOTICESEXPERIMENTAL ULTRASONIC TEST TRAIN VUR 505

The above train will operate on B.R. for an experimental period and the instructions on Pages 4.15 and 4.16 of the General Appendix apply with the following modifications:-

- 2(d) The air brake test must be carried out by the Guard from the rear driving cab.
5. Whilst on running lines, the following arrangements must be applied in respect of the driving of the train:-

Whilst running from site to site under normal running conditions and during testing, the train will be driven by the Speno Driver who must be accompanied by a Motive Power Conductor.

(30)

WORKING OF CLASS 313 AND CLASS 416 ELECTRIC MULTIPLE UNIT
TRAINS BETWEEN DALSTON WESTERN JN AND STRATFORD MARKET

Class 313 Electric Multiple Units

These units must only work between Navarino Road Jn and Stratford Market stabling sidings when either the Graham Road Curve route to Liverpool Street is not available, or when the pantographs have failed to rise. When operating between Dalston Kingsland and Stratford Market stabling sidings and return in the D.C. mode, Drivers must not advance the controller beyond Notch 2.

THESE UNITS MUST NOT RUN BEYOND STRATFORD MARKET TOWARDS NORTH WOOLWICH.

SECTION D - GENERAL INSTRUCTIONS AND NOTICES - continuedMISCELLANEOUS NOTICES - continuedWORKING OF CLASS 313 AND CLASS 416 ELECTRIC MULTIPLE UNIT TRAINS BETWEEN DALSTON WESTERN JN AND STRATFORD MARKET - continuedClass 416 Electric Multiple Units

Not more than two Class 416 units may be coupled together.

When two Class 416 units are running in multiple between Dalston Western Jn and Stratford Market, including the stabling sidings or return, Drivers must not advance the controller beyond Notch 2.

(UFN)

BETWEEN STEPNEY EAST AND FENCHURCH STREET

Until further notice, staff of the Docklands Light Railway will be laying in track adjacent to the Up Main/Slow line between Stepney East Station (lm. 58chs.) and Fenchurch Street. Restricted clearances exist and Drivers must keep a sharp look out and be prepared to sound the warning horn as necessary.

(UFN)

BETHNAL GREEN STATION

Until Further Notice, whilst demolition work is taking place, Drivers of 4-Car EMU trains must stop their trains at the temporary stop boards provided.

(UFN)

DALSTON (KINGSLAND) STATION

The Down and Up platforms have been temporarily shortened at the Stratford end by 25 yards and only accommodate two coaches. Drivers of Down trains booked to stop at this station must bring their train to a stand at signal DW14/16. Drivers of Up trains booked to stop at this station must bring their train to a stand at the temporary stop board which has been provided adjacent to the footbridge.

(LM) (UFN)

CAMBRIDGE HEATH STATION

Whilst platform repairs are taking place, Drivers of trains must stop their trains at the temporary stop boards provided.

(UFN)

LONDON FIELDS STATION

The station has reopened but platform repairs are taking place. Whilst this work is being carried out, Drivers must stop their trains at the temporary stop boards provided.

(UFN)

SECTION D - GENERAL INSTRUCTIONS AND NOTICES - continuedMISCELLANEOUS NOTICES - continuedSAWBRIDGEWORTH STATION

The stop board on the Up platform has been temporarily moved 9 yards towards the Country side of its former position.

(UFN)

WANSTEAD PARK STATION

Whilst platform repairs are taking place, Drivers of Up trains must stop their trains at the temporary stop boards provided.

(UFN)

REPAIRS IN MOTIVE POWER DEPOTS, CARRIAGE SHEDS, WAGON REPAIR SHEDS AND WAREHOUSES

In connection with work being carried out at the undermentioned places, scaffolding or projections may be provided or unusual excavations may be made in the ground:-

Location	Nature of Work	Duration	Commencing date
Stratford T.M.D. All lines.	Repairs to Motive Power Depot. Cranes and mechanical equipment in use.	Continuously. Until Further Notice.	-
Ilford EMU Depot, Nos. 19 and 20 Roads.	Drainage.	08 00 to 17 00 daily. Until Further Notice.	-
Ilford EMU Depot, Carriage Washer Roads BLOCKED	Renewal of carriage washer plant. <u>Isolation of electrical sections 361R.</u>	Continuously. Until Further Notice.	-
Norwich Crown Point T & R.S. M.D., All lines BLOCKED	Construction work (overhead line) and track maintenance. Mechanical equipment in use. <u>Possession to be given up for passage of trains.</u>	08 00 to 17 00 daily. Until further notice.	-
East Ham EMU Depot, All lines.	Shed reconstruction.	Continuously. Until Further Notice.	-

SECTION D - GENERAL INSTRUCTIONS AND NOTICES - continuedMISCELLANEOUS NOTICES - continuedREPAIRS IN MOTIVE POWER DEPOTS, CARRIAGE SHEDS, WAGON REPAIR SHEDS AND WAREHOUSES - continued

In connection with work being carried out at the undermentioned places, scaffolding or projections may be provided or unusual excavations may be made in the ground:-

Location	Nature of Work	Duration	Commencing date
East Ham EMU Depot, Washer Road BLOCKED	Repairs to washer plant. <u>Isolation of electrical sections 509A.</u>	Continuously. Until Further Notice.	-
East Ham EMU Depot, Nos. 10 and 11 Maintenance Shed Roads BLOCKED	Construction work. <u>Isolation of electrical sections EH10, EH11.</u>	Continuously. Until Further Notice.	-
East Ham EMU Depot, Nos. 17, 18, 19 and 20 Sidings BLOCKED to electric trains	In connection with engineering work between East Ham and Barking. Crane and mechanical equipment in use. <u>Isolation of electrical sections 509J.</u>	21 15 Mon to Fri to 05 15 Tue to Sat.	<u>From Monday 29 September until Saturday 4 October.</u>
East Ham EMU Depot, Nos. 17, 18, 19 and 20 Sidings BLOCKED to electric trains	In connection with engineering work between East Ham and Barking. Crane and mechanical equipment in use. <u>Isolation of electrical sections 509J.</u>	01 30 to 04 45. <u>Sunday 5 October.</u>	-
East Ham EMU Depot, Nos. 17, 18, 19 and 20 Sidings BLOCKED to electric trains	In connection with engineering work between East Ham and Barking. Crane and mechanical equipment in use. <u>Isolation of electrical sections 509J.</u>	21 15 Mon to Fri to 05 15 Tue to Sat.	<u>From Monday 6 until Saturday 11 October.</u>

* AUTOMATIC OPEN LEVEL CROSSINGS *

* LOCALLY MONITORED (A.O.C.L.) *

* Drivers are reminded that they must approach the above level crossings *
* prepared to STOP, UNLESS the Driver's white light is flashing and the *
* crossing is seen to be clear. *

* If the Driver's white light does not flash, the Driver MUST stop short of *
* the crossing and must not pass over it until he is satisfied it is safe *
* to do so. This is both a requirement of the Department of Transport and *
* Clause 3.3 of the Instruction on Page 7.3 of the General Appendix. *

BRITISH RAIL
EASTERN REGION

SE

29

WEEKLY OPERATING NOTICE

CONTAINING

TEMPORARY SPEED RESTRICTIONS

TEMPORARY ENGINEERING WORKS

SIGNALLING AND
PERMANENT WAY ALTERATIONS

GENERAL INSTRUCTIONS AND NOTICES

SATURDAY 11 OCTOBER

TO

FRIDAY 17 OCTOBER 1986

INCLUSIVE

Trainmen must pay particular attention to works contained in this notice and keep a good look-out for handsignals which may be exhibited in accordance with the Rules and Regulations.

Work at places other than those mentioned may be in progress and Drivers must be on the look-out and be prepared to stop or run at reduced speed when, and where, handsignals may be exhibited.

SECTION A

TEMPORARY SPEED RESTRICTIONS

(Until further notice unless otherwise specified)

Warning Boards and Indicators provided unless otherwise shown.

† Indicates that the Warning Boards and Indicators will be moved as the work progresses. Where two speeds are shown for a restriction e.g. $\frac{20}{40}$ the Rule

Book, Section U, Clause 1.2 applies.

Location	Lines affected	Mileage		Restr- iction m.p.h.	Remarks
		at or between M. Ch. M. Ch.			
<u>LIVERPOOL STREET TO NORWICH</u>					
1 Bethnal Green Station Jn and Bow Jn	Down Electric	Up Electric	1 55	2 12	20 Trackwork. (86/28)
2 Ilford Car Sheds and Goodmayes Station	Down Main	-	8 37	8 55	20 Trackwork. <u>Warning board also provided on Down Electric line at 7m. 72chs.</u> (86/23)
3 Goodmayes Station and Ilford Car Sheds	-	Up Main	8 55	8 37	20 Trackwork. <u>Warning board also provided on Up Electric line at 9m. 23chs.</u> (86/23)
4 Romford and Gidea Park Station	Down Electric	Up Electric	12 15	12 48	20 Trackwork. (86/24)
5 Harold Wood and Brentwood	Down Main	-	15 02	15 42	$\frac{20}{40}$ Condition of track. (85/61)
6 Brentwood and Ingatestone	Down Main	-	19 65	20 33	50 Condition of track. (86/14)
7 Church Lane LC and Chelmsford	Down	Up	29 24	29 57	20 Trackwork. (86/26)

SECTION A - TEMPORARY SPEED RESTRICTIONS - continued

Location	Lines affected		Mileage		Restr- iction	m.p.h.	Remarks
			M. Ch. M.	Ch. M. Ch.			
<u>LIVERPOOL STREET TO NORWICH - continued</u>							
8 Chelmsford and New Hall G.F.	Down	-	30 50	30 65	50		Condition of track. (86/12)
9 New Hall G.F. and Witham	Down	-	35 65 †	36 20	30		Trackwork. From 23 00 <u>Saturday 11</u> <u>until 16 00</u> <u>Sunday 12</u> <u>October.</u>
10 Witham and New Hall G.F.	-	Up	36 20	35 65	20		Trackwork. (86/28)
11 Hatfield Peveler and Witham	Down	-	37 20 †	38 00	40		Condition of track. (86/28)
12 Kelvedon	-	Up	42 25	42 10	<u>50</u> 80		Condition of track. (86/7)
13 Long Green LC and Marks Tey Station	Down	Up	46 26	46 28	40		Bridgework. From 00 01 <u>Sunday 12</u> <u>October.</u> (86/29)
14 Palgrave LC and Rectory Road LC	-	Up	91 40	91 20	20		Earthwork. (86/28)
15 Swainsthorpe and Trowse Lower Jn	Down	-	112 30	112 70	30		Trackwork. Until 10 00 <u>Wednesday 15</u> <u>October.</u> (86/27)

SHENFIELD JN TO SOUTHEND VICTORIA

16 Billericay and Wickford Station	Down	-	26 10	26 44	40		Condition of track. (86/14)
17 Wick Lane LC and Rayleigh	Down	-	31 35	31 75	40		Condition of embankment. (84/41)

SECTION A - TEMPORARY SPEED RESTRICTIONS - continued

Location	Lines affected	Mileage		Restr- iction	Remarks
		at or between M. Ch. M. Ch.	m.p.h.		
<u>WICKFORD JN TO SOUTHMINSTER</u>					
18 Althorne LC and Burnham-on- Crouch	Single	41 10 † 42 10	20	Trackwork. (85/45)	
<u>WITHAM TO BRAINTREE</u>					
19 Cressing and Braintree	Single	18 75 18 68	20	Bridgework (No. 2102B). <u>From 09 00</u> <u>Monday 13</u> <u>October.</u> (86/29)	
<u>COLCHESTER TO CLACTON</u>					
20 Colchester Road - LC and Wivenhoe	Up	57 72 † 57 12	40	Condition of track. (86/26)	
<u>MANNINGTREE SOUTH JN TO HARWICH</u>					
21 Parkeston Goods - Jn and Wrabness	Up	66 70 66 10	<u>30</u> 50	Condition of track. (86/3)	
<u>EAST SUFFOLK JN TO OULTON BROAD NORTH JN</u>					
22 Bealings LC and Westerfield Jn	Up	74 60 † 73 44	20	Trackwork. (86/21)	
<u>WESTERFIELD JN TO FELIXSTOWE</u>					
23 Trimley	Single	82 55 82 69	20	Trackwork. (86/28)	
<u>NORWICH TO LOWESTOFT</u>					
24 Thorpe Jn and Whitlingham Jn	Down Up	0 36 0 44	20	Trackwork. (85/20)	

SECTION A - TEMPORARY SPEED RESTRICTIONS - continued

Location	Lines affected		Mileage		Restr- iction m.p.h.	Remarks
			at M.	between Ch. M. Ch.		
<u>NORWICH TO LOWESTOFT - continued</u>						
25 Whitlingham Jn and Brundall Jn	Down	Up	4 59 †	5 62	20	Trackwork. (86/28)
<u>BETHNAL GREEN JN TO KING'S LYNN</u>						
26 Cambridge Heath	Down Suburban	Up Suburban	1 57	1 67	20	Platform work. (86/24)
27 Angel Road and Brimsdown	Down	Up	9 60	10 02	20	Trackwork. <u>From 14 00</u> <u>Friday 17</u> <u>October.</u> (86/29)
28 Brimsdown and Waltham Cross	Down	Up	11 54	12 12	20	Trackwork. (86/11)
29 Cheshunt Station and Wharf Road LC	Down	-	15 12 †	15 79	40	Trackwork. (86/26)
30 Wharf Road LC and Cheshunt Station	-	Up	15 79 †	15 12	30	Trackwork. (86/26)
31 Sawbridgeworth and Harlow Mill	-	Up	24 76	24 70	60	Condition of track. (86/16)
32 Whittlesford Station	-	Up	49 10	49 00	40	Platform work. <u>From 08 00</u> <u>Monday 13</u> <u>October.</u> (86/29)
<u>COLDHAM LANE JN TO HAUGHLEY JN</u>						
33 Elmswell LC and Haughley Jn	Down	-	37 15 †	38 00	30	Trackwork. (86/27)

SECTION A - TEMPORARY SPEED RESTRICTIONS - continued

Location	Lines affected	Mileage		Restr- iction m.p.h.	Remarks
		at or between M. Ch. M. Ch.			
<u>ELY NORTH JN TO PETERBOROUGH, CRESCENT JN</u>					
34 Third Drove LC and Welney Road LC	Down	Up	78 00 78 18	20	Condition of track. (86/21)
35 Third Drove LC and Welney Road LC	Down	Up	78 42 78 60	20	Condition of track. (86/21)
36 March East Jn and Badgeney Road LC	-	Up Main	85 40 85 29	20	Trackwork. (85/54) <u>Warning board positioned at signal ME.45.</u> <u>Additional warning board provided on the March East Jn to Wisbech line, positioned at signal ME.52.</u>
37 Three Horse Shoes No. 3 LC	Down	Up	90 74 90 78	<u>20</u> 50	Condition of track. (86/24)
<u>ELY NORTH JN TO TROWSE LOWER JN</u>					
38 Eaton LC and Trowse Lower Jn	Down	Up	121 60 121 64	20	Bridgework (Nos. 1640 and 1640A). (86/23)
<u>FENCHURCH STREET TO SHOEBURYNESS</u>					
39 Southend Central and Thorpe Bay	Down	-	36 31 36 65	30	Trackwork. <u>From 14 00</u> <u>Friday 17</u> <u>October.</u> (86/29)
40 Thorpe Bay and Southend Central	-	Up	36 65 36 31	20	Trackwork. <u>From 14 00</u> <u>Friday 17</u> <u>October.</u> (86/29)

SECTION A - TEMPORARY SPEED RESTRICTIONS - continued

Location	Lines affected	Mileage at or between		Restr- iction m.p.h.	Remarks
		M. Ch. M.	Ch. m.p.h.		
<u>UPPER HOLLOWAY TO BARKING, TILBURY LINE JN WEST</u>					
41 South Tottenham East Jn and Black Horse Road	Down -	6 45	6 57	20	Condition of track. (85/18)
42 Woodgrange Park Jn and Wanstead Park	- Up	11 50	11 44	20	Bridgework (No. 467). <u>From 14 00</u> <u>Friday 17</u> <u>October.</u> (86/29)
<u>TILBURY RIVERSIDE TO PITSEA</u>					
43 Stanford-le- Hope and Gardners LC	Down -	30 11	30 60	40	Condition of track. (86/1)

SECTION B

TEMPORARY ENGINEERING WORKS

At or between	Lines affected	Remarks
<u>LIVERPOOL STREET TO NORWICH</u>		
UNTIL FURTHER NOTICE		
44	Liverpool Street Station Platforms 1 to 10 Inc.	Repairs to station roof. Mechanical equipment in use. (84/41)
45	Liverpool Street Station Platforms 1 to 18 inc.	Cleaning track. (85/21)
46	Liverpool Street Station Platforms 8, 10 and 11 to 18 inc.	Platform work and construction work. Mechanical equipment in use. (86/21)
47	Bethnal Green Station Down Main and Down and Up Suburban	08 00 to 16 00. Demolition work. (See Section 'D'). (85/41)
48	Bethnal Green and Bow Jn All	Signalling work. (86/25)
49	Stratford and Bow Jn Up Electric	07 30 to 18 00. Construction work. Mechanical equipment in use. (85/62)
50	Forest Gate Jn and Ilford All	07 00 to 18 00. Bridgework (No. 75A). 7m. 08chs. Mechanical equipment in use. (85/20)
51	Ilford Station All	08 00 to 17 00. Repairs to station roof and painting station. (86/2)
52	Romford Jn and Gidea Park All	Bridgework (No. 102B). 12m. 48chs. Crane and mechanical equipment in use. (85/54)
53	Ingatestone and Chelmsford Down and Up	07 30 to 18 00. Construction of bridge (No. 143A). 26m. 51chs. Mechanical equipment in use. (84/35)
54	Chelmsford and Hatfield Peverel Down and Up	07 30 to 16 00. Earthwork. 35m. 53chs. (85/27)
55	Colchester Jn and Ardleigh LC Down Main	08 00 to 17 00. Earthwork and formation renewal. 52m. 25chs. and 53m. 75chs. Mechanical equipment in use. (85/41)

SECTION B - TEMPORARY ENGINEERING WORKS - continued

At or between	Lines affected	Remarks
<u>LIVERPOOL STREET TO NORWICH - continued</u>		
UNTIL FURTHER NOTICE - continued		
56 Manningtree North Jn and Bentley LC	Down and Up <u>Between Trains</u>	07 00 to 18 00. Tree felling, bridgework (No. 229) and earthwork. 60m. 06chs. and 61m. 06chs. Crane and mechanical equipment in use. (85/15)
57 Ipswich Goods Jn and Needham Market	Down Main	08 00 to 16 00. Construction work. 69% and 76m.p. (86/19)
58 East Suffolk Jn and Claydon LC	Down and Up	08 00 to 16 00. Bridgework (No.254A). 70m. 17chs. (85/58)
59 Mellis	Down and Up	07 30 to 18 00. Demolition work. 91 $\frac{1}{2}$ mp. Mechanical equipment in use. (86/12)
60 Mellis and Trowse Lower Jn	All <u>Between Trains</u>	07 30 to 18 00. Signalling work. Points and signals disconnected. (86/15)
61 Diss and Mellis	Up	08 00 to 15 00. Construction work. 94m. 05chs. and 94m.p. (86/17)
62 Diss	Down and Up	07 00 to 19 00. Earthwork. Crane and mechanical equipment in use. (85/27)
63 Diss and Audley End LC	Down and Up	Bridgework (No. 315). 95m. 29chs. (86/16)
64 Diss and Tivetshall Jn	Down and Up	07 30 to 18 00. Demolition work 97m 50chs. Mechanical equipment in use. (86/12)
65 Gissing LC	Down and Up	08 00 to 16 00. Level crossing road repairs. 98m. 56chs. Mechanical equipment in use. (86/26)
66 Hales Street LC	Down and Up	08 00 to 16 00. Level crossing road repairs. 100m. 26chs. Mechanical equipment in use. (86/28)

SECTION B - TEMPORARY ENGINEERING WORKS - continued

<u>At or between</u>	<u>Lines affected</u>	<u>Remarks</u>
<u>LIVERPOOL STREET TO NORWICH - continued</u>		
UNTIL FURTHER NOTICE - continued		
67 Tivetshall Jn	Down and Up	07 30 to 18 00. Demolition work and level crossing road repairs. (Tivetshall Jn LC). 100 $\frac{3}{4}$ m.p. Mechanical equipment in use. (86/28)
68 Tivetshall Jn and Swainsthorpe	Down and Up <u>Between Trains</u>	07 30 to 18 00. Bridgework (Nos. 328 and 331A) and demolition work. 103m. 13chs. and 104m. 59chs. Crane and mechanical equipment in use. (86/8)
69 Newton Flotman LC	Down and Up	08 00 to 16 00. Level crossing road repairs. 108m. 17chs. Mechanical equipment in use. (86/26)
70 Swainsthorpe	Down and Up <u>Between Trains</u>	07 30 to 18 00. Demolition work. 109 $\frac{3}{4}$ m.p. Mechanical equipment in use. (86/8)
71 Swainsthorpe and Trowse Lower Jn.	Down and Up	07 00 to 16 00. Bridgework (No. 346). 110m. 62chs. Mechanical equipment in use. (86/25)
72 Trowse Lower Jn and Norwich Station	All <u>Between Trains</u>	07 00 to 17 00. Construction work (overhead line), earthwork, track maintenance and signalling work. Points and signals disconnected. (86/7)
73 Trowse Swing Bridge	Down and Up <u>Between Trains</u>	Bridgework (No. 356). 123m. 36chs. Crane and mechanical equipment in use. (85/33)
74 Trowse Swing Bridge and Thorpe Jn	Down and Up <u>Between Trains</u>	07 30 to 18 00. Construction work. 123 $\frac{1}{2}$ m.p. Crane and mechanical equipment in use. (86/3)
75 Norwich Station	All	Track renewal, platform work and earthwork. Crane and mechanical equipment in use. (85/62)

FRIDAY/SATURDAY 10/11 OCTOBER

76 Liverpool Street Station	Platforms 1, 2, 3 and 4 BLOCKED	23 00 to 06 20. Repairs to station roof. <u>Isolation of electrical sections 306ABC. Trains to be replatformed as necessary.</u>
-----------------------------	------------------------------------	--

SECTION B - TEMPORARY ENGINEERING WORKS - continued

At or between	Lines affected	Remarks
---------------	----------------	---------

LIVERPOOL STREET TO NORWICH - continued

FRIDAY/SATURDAY 10/11 OCTOBER - continued

77	Bethnal Green and Stratford (London End)	Down and Up Electric BLOCKED	23 00 to 05 00. Overhead line work and track maintenance. Mechanical equipment in use. <u>Isolation of electrical sections 309A, 310B.</u> <u>Trains to travel over Main lines.</u>
78	Colchester and Hythe Jn	Down Clacton Avoiding and Clacton Single/ Down and Up Clacton BLOCKED)23 59 to 04 45. Overhead line work.)Mechanical equipment in use.) <u>Isolation of electrical sections 339K, 340N, 381E, 382A. Possession to be given up for passage of Engineers' trains. Electric trains to be replatformed as necessary.</u>
	Colchester	Platform 5 and Bridge Road BLOCKED to electric trains))))

SATURDAY 11 OCTOBER

79	Liverpool Street Station	Platforms 8 and 10 BLOCKED	05 00 to 12 30)Repairs to station roof. <u>Trains to be replatformed as necessary.</u>
		Platform 7 BLOCKED to electric trains	05 00 to 12 30)12 30 <u>Isolation of electrical sections 305CEFGH.</u>
		Platform 9 BLOCKED	05 00 to 15 45))
80	Bethnal Green	Down and Up Main and Down Electric	08 00 to 16 00. Signalling work (No. 59B points).
81	Maryland and Seven Kings	All	00 45 to 02 45. Signalling work. Points and signals disconnected.

SATURDAY 11 TO SUNDAY 12 OCTOBER

82	Chadwell Heath Jn and Gidea Park Station Jn	Down and Up Electric BLOCKED Down and Up Main	20 30 Sat. to 22 00 Sun. Track renewal, formation renewal, track maintenance and overhead line work. Mechanical equipment in use. <u>Isolation of electrical sections 325DE, 326AB.</u> <u>Trains to travel over Main lines.</u>
----	---	---	---

SECTION B - TEMPORARY ENGINEERING WORKS - continued

At or between	Lines affected	Remarks
<u>LIVERPOOL STREET TO NORWICH - continued</u>		
SATURDAY/SUNDAY 11/12 OCTOBER		
83 Bethnal Green and Stratford (London End)	Down and Up Electric BLOCKED Down and Up Main	23 00 to 18 00. Track maintenance, overhead line work and unloading materials. Mechanical equipment in use. <u>Isolation of electrical sections 309A, 310B. Trains to travel over Main lines.</u>
84 Ilford Car Sheds (London End Jn) and Chadwell Heath Jn	Down and Up Main BLOCKED	23 00 to 19 00. Track renewal, track maintenance and bridgework (No. 86). Crane and mechanical equipment in use. <u>Isolation of electrical sections 323B, 324D. Trains to travel over Electric lines.</u>
85 Shenfield and Witham	All BLOCKED to electric trains	23 50 to 13 30. In connection with engineering work. <u>Isolation of electrical sections 333, 334, 335 and 336.</u>
86 New Hall G.F. and Witham	Up BLOCKED Down BLOCKED	23 15 to 16 00) Track maintenance,) track renewal, 23 50 to 13 30) formation renewal,) trimming lineside) vegetation, drainage) and overhead line work.) Mechanical equipment in) use. 23 50 Sat to) 13 30 Possession to be) <u>given up for 1Y02 02 20</u>) <u>Liverpool Street to</u>) <u>Stowmarket and 1F04</u>) <u>09 20 Liverpool Street</u>) <u>to Harwich Parkeston</u>) <u>Quay over Down line,</u>) <u>and for passage of 1C01</u>) <u>07 25 Harwich Parkeston</u>) <u>Quay to Liverpool</u>) <u>Street over Down line</u>) <u>under single line</u>) <u>working.</u>) <u>13 30 to 16 00 Sun</u>) <u>Single line working</u>) <u>over Down line.</u>

SECTION B - TEMPORARY ENGINEERING WORKS - continued

At or between	Lines affected	Remarks
<u>LIVERPOOL STREET TO NORWICH - continued</u>		
SATURDAY/SUNDAY 11/12 OCTOBER - continued		
87 Witham and Kelvedon	Down BLOCKED	23 55 to 07 45. Track maintenance. 39m.p. and 39m. 10chs. Mechanical equipment in use. <u>Possession to be given up for passage of 1Y02 02 20 Liverpool Street to Stowmarket.</u>
88	Not used.	
89 Haughley Jn and Diss	Up BLOCKED Down BLOCKED	22 00 to 15 30)Track renewal. Crane)and mechanical 23 30 to 07 15)equipment in use.) <u>07 15 to 15 30 Sun</u>) <u>Single line working</u>) <u>over Down line.</u>
90	Not used.	
91 Diss and Swainsthorpe	Up BLOCKED Down BLOCKED	22 00 to 07 00)Bridgework (No. 315),)track maintenance and 23 45 to 10 30)track renewal.)Mechanical equipment)in use.
92 Trowse Lower Jn and Norwich	'C' line/Up Main BLOCKED Down Main/ 'W' line BLOCKED	22 00 to 06 45)Track renewal.)Mechanical equipment 23 55 to 12 00)in use. <u>22 00 Sat to</u>) <u>06 45 Possession to be</u>) <u>given up for passage</u>) <u>of 1P04 02 10 Liverpool</u>) <u>Street to Yarmouth over</u>) <u>Up Main/'C' line under</u>) <u>single line working.</u>) <u>06 45 to 12 00 Sun</u>) <u>Single line working</u>) <u>over Up Main/'C'</u>) <u>line.</u>

SECTION B - TEMPORARY ENGINEERING WORKS - continued

At or between	Lines affected		Remarks
<u>LIVERPOOL STREET TO NORWICH - continued</u>			
SATURDAY/SUNDAY 11/12 AND SUNDAY 12 OCTOBER			
93	Liverpool Street and Bethnal Green	Down and Up Suburban BLOCKED to electric trains	23 15 Sat to 18 00)Repairs to station)roof and overhead)line work.)Mechanical)equipment in use.
	Liverpool Street Station	Platforms 9 and 10 BLOCKED to electric trains	23 15 Sat to 04 15)Isolation of) <u>electrical</u>) <u>sections 305 and 306. Electric</u>) <u>trains to travel</u>
		Platforms 1 to 8 inc. BLOCKED	23 15 Sat to 18 00) <u>over Main or</u>) <u>Electric lines.</u>) <u>Trains to be</u>) <u>replatformed as</u>
		Locomotive Holding Sidings BLOCKED to electric trains	23 15 Sat to 18 00) <u>necessary.</u>)))
		Platforms 9 and 10 BLOCKED	04 15 to 18 00 Sun)))
94	Church Lane LC and New Hall G.F.	Up BLOCKED Down BLOCKED Up	23 25 Sat to 13 45)Track maintenance,)track renewal and 23 45 Sat to 13 50)overhead line work.)Mechanical 13 45 to 16 00 Sun)equipment in use.) <u>Possession to be</u>) <u>given up for</u>) <u>passage of 1Y02</u>) <u>02 20 Liverpool</u>) <u>Street to</u>) <u>Stowmarket and</u>) <u>1F04 09 20</u>) <u>Liverpool Street to</u>) <u>Harwich Parkeston</u>) <u>Quay over Down</u>) <u>line, and for</u>) <u>passage of 1C01</u>) <u>07 25 Harwich</u>) <u>Parkeston Quay to</u>) <u>Liverpool Street</u>) <u>over Down line</u>) <u>under single line</u>) <u>working.</u>

SECTION B - TEMPORARY ENGINEERING WORKS - continued

At or between	Lines affected	Remarks
<u>LIVERPOOL STREET TO NORWICH - continued</u>		
SATURDAY/SUNDAY 11/12 AND SUNDAY 12 OCTOBER - continued		
95 Swainsthorpe and Trowse Lower Jn	Up BLOCKED Down BLOCKED Up Down	22 00 Sat to 06 45) Bridgework (No.346), track 23 50 Sat to 10 00) maintenance and) track renewal. 06 45 to 16 00 Sun) Mechanical) equipment in use. 10 00 to 16 00 Sun)
SATURDAY 11 TO FRIDAY 17 OCTOBER		
96 Norwich and Whitlingham Jn	'A' and 'E' lines/ Down and Up Lowestoft/Main BLOCKED) 23 30 Sat to Thu to 05 00 Sun to) Fri. Construction work (overhead) line) and track maintenance.) Mechanical equipment in use.) <u>Possession to be given up for passage</u>) <u>of trains.</u>
Norwich Station	Platforms 4, 5 and 6 BLOCKED)))
SUNDAY 12 OCTOBER		
97 Liverpool Street Station	Platform 11 BLOCKED Platform 12, and connections between Main lines and Platforms 13 and 14 BLOCKED to electric trains	03 30 to 08 00. Construction work. Mechanical equipment in use. <u>Isolation of electrical sections</u> <u>304ABE. Electric trains to/from</u> <u>platforms 13 and 14 to travel over</u> <u>Electric lines. Trains to be</u> <u>replatformed as necessary.</u>
98 Stratford (Country End)	Down and Up Main	08 00 to 16 00. Signalling work (No. 263A points). Points disconnected.
99 Gidea Park (Country End)	Down and Up Electric	08 00 to 16 00. Signalling work (No. 40B points).
100 Shenfield and Church Lane LC	Down Main BLOCKED	00 30 to 07 00. Track maintenance 23% and 23% m.p. <u>Possession to be</u> <u>given up for passage of 1Y02 02 20</u> <u>Liverpool Street to Stowmarket.</u>

SECTION B - TEMPORARY ENGINEERING WORKS - continued

At or between	Lines affected	Remarks
<u>LIVERPOOL STREET TO NORWICH - continued</u>		
SUNDAY 12 OCTOBER - continued		
101 Witham and Colchester	All BLOCKED to electric trains	00 15 to 07 15. In connection with engineering work. <u>Isolation of electrical sections 337, 338, 339DEFGH, 340ABCD.</u>
102 Kelvedon and Marks Tey Station	Down and Up BLOCKED	00 05 to 07 15. Bridgework. 46m. 27chs. <u>Possession to be given up for passage of 1Y02 02 20 Liverpool Street to Stowmarket over Down line.</u>
103 Marks Tey Station and Colchester	Down and Up Main BLOCKED	00 15 to 07 15. Bridgework (Nos. 201 and 202). Mechanical equipment in use. <u>Possession to be given up for passage of 1Y02 02 20 Liverpool Street to Stowmarket over Down Main line.</u>
SUNDAY 12 TO FRIDAY 17 OCTOBER		
104 Trowse Yard and Norwich Station	All BLOCKED	23 15 Sun to Thu to 05 00 Mon to Fri. Construction work (overhead line), track maintenance and track renewal. Mechanical equipment in use. <u>Possession to be given up for passage of trains.</u>
MONDAY 13 OCTOBER		
105 Bethnal Green (London End) and Seven Sisters	Down and Up Suburban/ Down and Up BLOCKED to electric trains	01 15 to 04 45. In connection with overhead line work between Bethnal Green and Hackney Downs. <u>Isolation of electrical sections 313, 314, 401DE, 402ABC. Electric trains to travel over Fast lines and to be diverted via Clapton.</u>
106 Maryland and Seven Kings	All	00 45 to 02 45. Signalling work. Points and signals disconnected.
107 Goodmayes Jn and Gidea Park Jn	Down and Up Main BLOCKED	01 00 to 05 00. Overhead line work. <u>Isolation of electrical sections 323A, 324E, 327C, 328A. Trains to travel over Electric lines.</u>

SECTION B - TEMPORARY ENGINEERING WORKS - continued

At or between	Lines affected	Remarks
<u>LIVERPOOL STREET TO NORWICH - continued</u>		
MONDAY 13 OCTOBER - continued		
108 Witham and New Hall G.F.	Up BLOCKED Up	00 01 to 04 50)Track maintenance and)signalling work. 04 50 to 06 00)Mechanical equipment in)use. <u>Single line</u>) <u>working over Down line.</u>
109 Hill House G.F. All and Manningtree North Jn	All BLOCKED to electric trains	01 40 to 04 00. In connection with overhead line work between Colchester and Ardleigh LC. <u>Isolation of</u> <u>electrical sections 339, 340, 341 and</u> <u>342.</u>
110 Colchester and Ardleigh LC	Down and Up Main BLOCKED	01 40 to 04 00. Overhead line work. <u>Possession to be given up for passage</u> <u>of Diesel trains.</u>
MONDAY 13 TO THURSDAY 16 OCTOBER		
111 Chadwell Heath Jn and Gidea Park Station Jn	Down and Up Electric BLOCKED	10 15 to 15 15 daily. Track maintenance and track renewal. Mechanical equipment in use. <u>Trains to travel over Main lines.</u>
MONDAY 13 TO FRIDAY 17 OCTOBER		
112 Stratford (London End) and Forest Gate Jn	Down and Up Electric BLOCKED	23 55 Mon to Thu to 05 35 Tue to Fri. Track maintenance. Mechanical equipment in use. <u>Trains to travel</u> <u>over Main lines.</u>
113 East Suffolk Jn and Claydon LC	Down Main BLOCKED	23 35 Mon to Thu to 05 30 Tue to Fri. Track maintenance. Mechanical equipment in use. <u>Single line</u> <u>working over Up Main line.</u>
MONDAY 13 TO SATURDAY 18 OCTOBER		
114 Liverpool Street Station	Platforms 1, 2, 3 and 4 BLOCKED	23 00 Mon to Fri to 06 30 Tue to Sat. Repairs to station roof and overhead line work. <u>Isolation of electrical</u> <u>sections 306ABC. Trains to be</u> <u>replatformed as necessary.</u>

SECTION B - TEMPORARY ENGINEERING WORKS - continued

<u>At or between</u>	<u>Lines affected</u>	<u>Remarks</u>
----------------------	-----------------------	----------------

LIVERPOOL STREET TO NORWICH - continued

MONDAY 13 TO SATURDAY 18 OCTOBER - continued

115 Ilford Car Sheds (London End Jn) and Chadwell Heath Jn	Down and Up Main BLOCKED	21 15 Mon to Fri to 05 00 Tue to Sat. Overhead line work. Mechanical equipment in use. <u>Isolation of electrical sections 323B, 324D.</u> <u>Trains to travel over Electric lines.</u>
--	-----------------------------	--

TUESDAY 14 AND WEDNESDAY 15 OCTOBER

116 Chelmsford and Church Lane LC	Up BLOCKED	00 10 to 05 00 daily. Track maintenance. Mechanical equipment in use. <u>Single line working over Down line.</u>
-----------------------------------	---------------	--

WEDNESDAY/THURSDAY 15/16 OCTOBER

117 Ardleigh LC and Colchester	Up Main BLOCKED	23 45 to 05 45. Track maintenance. Mechanical equipment in use. <u>Single line working over Down Main line.</u>
--------------------------------	--------------------	---

FRIDAY 17 TO MONDAY 20 OCTOBER

118 Bethnal Green and Stratford (London End)	Down and Up Electric BLOCKED	23 00 Fri to 05 00 Mon. Track maintenance, track renewal, overhead line work, bridgework (No. 46) and painting Bow Jn Signalbox. Crane and mechanical equipment in use. <u>Isolation of electrical sections 309A, 310B. Trains to travel over Main lines.</u>
--	------------------------------------	---

NAVARINO ROAD JN TO NORTH WOOLWICH

UNTIL FURTHER NOTICE

119 Highbury and Homerton	All	07 30 to 18 00. Earthwork and construction work. Mechanical equipment in use. (86/1)
---------------------------	-----	--

SECTION B - TEMPORARY ENGINEERING WORKS - continued

At or between	Lines affected	Remarks
<u>NAVARINO ROAD JN TO NORTH WOOLWICH - continued</u>		
SATURDAY 11 AND SUNDAY 12 OCTOBER		
120 Dalston Western Jn and Hackney Central	All BLOCKED to AC electric trains	08 00 to 22 00 daily. In connection with engineering work between Bethnal Green and Hackney Downs. <u>Isolation of electrical sections 314DEF.</u>

SUNDAY 12 OCTOBER

121 Navarino Road Jn and Channelsea North Jn	Down and Up BLOCKED	00 01 to 08 00. Construction work (overhead line). Crane and mechanical equipment in use. <u>Isolation of electrical sections 707 and 708.</u>
122 Channelsea North Jn and Stratford Central Jn West	Down and Up	00 01 to 08 00. Construction work (overhead line). <u>Isolation of electrical sections 705C, 706A.</u>
123 Channelsea South Jn and North Woolwich	All BLOCKED	00 15 to 08 00. Tunnelwork (Stratford Low Level and Silvertown Tunnels) and track maintenance. Crane in use. <u>Isolation of electrical sections 701, 702, 703, 704, 705A, 706A.</u>

MONDAY 13 OCTOBER

124 Dalston Western Jn and Hackney Central	All BLOCKED to AC electric trains	01 15 to 04 45. In connection with overhead line work between Bethnal Green and Hackney Downs. <u>Isolation of electrical sections 314DEF.</u>
---	---	--

STRATFORD, LEA JN TO HIGH MEADS JN

SUNDAY 12 OCTOBER

125 Lea Jn and High Meads Jn	Down and Up BLOCKED	00 01 to 08 00. Construction work (overhead line). Crane and mechanical equipment in use.
---------------------------------	------------------------	---

SECTION B - TEMPORARY ENGINEERING WORKS - continued

At or between	Lines affected	Remarks
---------------	----------------	---------

CHANNELSEA SOUTH JN TO STRATFORD CENTRAL JN WEST

UNTIL FURTHER NOTICE

126	Channelsea South Jn and Stratford Central Jn West	Down and Up BLOCKED to electric trains	In connection with engineering work. (86/14)
-----	---	--	---

SUNDAY 12 OCTOBER

127	Channelsea North Jn and Stratford Central Jn West	Down and Up	00 01 to 08 00. Construction work (overhead line). <u>Isolation of electrical sections 705C, 706A.</u>
-----	---	-------------	---

FOREST GATE JN TO WOODGRANGE PARK JN

SUNDAY 12 OCTOBER

128	Forest Gate Jn and Barking Station (Country End)	All BLOCKED to electric trains	00 50 to 20 00. In connection with engineering work. <u>Isolation of electrical sections 512 and 513.</u>
-----	---	--------------------------------------	--

SUNDAY 12 TO MONDAY 13 OCTOBER

129	Forest Gate Jn and Woodgrange Park Jn	Down and Up BLOCKED	00 50 Sun to 04 00 Mon. Overhead line work. <u>Possession to be given up for passage of Diesel trains.</u>
-----	---	------------------------	---

SUNDAY/MONDAY 12/13 OCTOBER

130	Forest Gate Jn and Barking Tilbury Line Jn West	Down and Up BLOCKED to electric trains	20 00 to 04 00. In connection with engineering work. <u>Isolation of electrical sections 512AB, 513EF.</u>
-----	--	--	---

SECTION B - TEMPORARY ENGINEERING WORKS - continued

At or between	Lines affected	Remarks
<u>SHENFIELD JN TO SOUTHEND VICTORIA</u>		
UNTIL FURTHER NOTICE		
131	Billericay Down and Up	07 30 to 17 30. Construction work and platform work. Mechanical equipment in use. (86/19)
132	Wickford Station	All Platform work and earthwork. (85/63)
133	Wickford Jn	All 08 00 to 17 00. Signalling work. (85/41)
134	Rayleigh and Hockley	Down 08 00 to 17 00. Earthwork 34½ and 34¾ m.p. Mechanical equipment in use. (85/61)
135	Southend Victoria Station	All 08 00 to 18 00. Repairs to station roof. (86/20)

SATURDAY 11 OCTOBER

136	Southend Victoria Station	Platforms 2 and 3 BLOCKED	08 00 to 18 00. Repairs to station roof and painting station. <u>Isolation electrical sections 375A, 376H.</u> <u>Trains to be replatformed as necessary.</u>
-----	---------------------------	---------------------------	--

WICKFORD JN TO SOUTHMINSTER

UNTIL FURTHER NOTICE

137	Wickford Jn	All	08 00 to 17 00. Signalling work. (85/41)
138	Fambridge Station	Single	07 30 to 18 00. Platform work. (85/55)
139	Burnham-on-Crouch	Single	07 30 to 18 00. Earthwork. 43m 24chs. (85/30)

SECTION B - TEMPORARY ENGINEERING WORKS - continued

At or between	Lines affected	Remarks
<u>WITHAM TO BRAINTREE</u>		
UNTIL FURTHER NOTICE		
140 Witham and Braintree	Single	07 00 to 18 00. Construction work (Bridge No. 2102B). (86/19)
FRIDAY/SATURDAY 10/11 OCTOBER		
141 Witham and Braintree	Single BLOCKED	23 40 to 05 30. Bridgework (No.2102B). <u>Isolation of electrical sections 379.</u>
SATURDAY/SUNDAY 11/12 OCTOBER		
142 Witham and Braintree	Single BLOCKED	23 40 to 08 45. Bridgework (No.2102B). <u>Isolation of electrical sections 379.</u>
MONDAY 13 TO SATURDAY 18 OCTOBER		
143 Witham and Braintree	Single BLOCKED	23 40 Mon to Fri to 05 30 Tue to Sat. Bridgework (No.2102B). <u>Isolation of electrical sections 379.</u>
<u>COLCHESTER TO CLACTON</u>		
UNTIL FURTHER NOTICE		
144 Colchester Jn and East Gate Jn	Down Clacton Avoiding	08 00 to 17 00. Earthwork. 52m. 25chs. and 52m. 29chs. Mechanical equipment in use. (85/38)

SECTION B - TEMPORARY ENGINEERING WORKS - continued

At or between	Lines affected	Remarks
<u>COLCHESTER TO CLACTON - continued</u>		
FRIDAY/SATURDAY 10/11 OCTOBER		
145 Colchester and Hythe Jn	Down Clacton Avoiding and Clacton Single/ Down and Up Clacton BLOCKED)23 59 to 04 45. Overhead line work.)Mechanical equipment in use.) <u>Isolation of electrical sections</u>) <u>339K, 340N, 381E, 382A. Possession</u>) <u>to be given up for passage of</u>) <u>Engineers' trains. Electric trains</u>) <u>to be replatformed as necessary.</u>
Colchester	Platform 5 and Bridge Road BLOCKED to electric trains))))
SATURDAY/SUNDAY 11/12 OCTOBER		
146 Hythe Station and Great Bentley	Down and Up BLOCKED	23 20 to 07 15. Bridgework (Wivenhoe Station footbridge), painting Wivenhoe Station and overhead line work. Mechanical equipment in use.
SUNDAY 12 OCTOBER		
147 Colchester Jn and Clacton	All BLOCKED to electric trains	00 10 to 07 15. In connection with engineering work between Hythe Station and Great Bentley. <u>Isolation of electrical sections 381, 382, 383, 384, 385 and 386.</u>
148 Thorpe-le-Soken and Clacton	Down and Up BLOCKED	00 10 to 07 30. Track maintenance. 68m. 04chs. Mechanical equipment in use.
TUESDAY/WEDNESDAY 14/15 OCTOBER		
149 Thorpe-le Soken and Clacton	Down BLOCKED	23 45 to 05 00. Trimming lineside vegetation. Mechanical equipment in use. <u>Isolation of electrical sections 385G.</u>

SECTION B - TEMPORARY ENGINEERING WORKS - continued

At or between	Lines affected	Remarks
<u>COLCHESTER TO CLACTON - continued</u>		
THURSDAY/FRIDAY 16/17 OCTOBER		
150 East Gate Jn and Thorpe-le-Soken	Down and Up BLOCKED	23 30 to 04 45. Track maintenance. Mechanical equipment in use. <u>Possession to be given up for passage of Freight trains to/from Hythe.</u>
<u>EAST GATE JN TO ST. BOTOLPHS</u>		
SUNDAY 12 OCTOBER		
151 East Gate Jn and St. Botolphs	All BLOCKED to electric trains	00 10 to 07 15. In connection with engineering work between Hythe Station and Great Bentley. <u>Isolation of electrical sections 381.</u>
<u>COLNE JN TO HYTHE JN</u>		
SUNDAY 12 OCTOBER		
152 Colne Jn and Hythe Jn	Down and Up BLOCKED to electric trains	00 10 to 07 15. In connection with engineering work between Hythe Station and Great Bentley. <u>Isolation of electrical sections 381.</u>
<u>THORPE-LE-SOKEN TO WALTON-ON-NAZE</u>		
SUNDAY 12 OCTOBER		
153 Thorpe-le-Soken and Walton-on-Naze	Single, BLOCKED to electric trains	00 10 to 07 15. In connection with engineering work between Hythe Station and Great Bentley. <u>Isolation of electrical sections 387.</u>
WEDNESDAY 15 TO FRIDAY 17 OCTOBER		
154 Thorpe-le-Soken and Walton-on-Naze	Single BLOCKED	23 30 Wed and Thu to 05 00 Thu and Fri. Track maintenance and trimming lineside vegetation. Mechanical equipment in use. <u>Isolation of electrical sections 387.</u>

SECTION B - TEMPORARY ENGINEERING WORKS - continued

At or between	Lines affected	Remarks
<u>MANNINGTREE SOUTH JN TO HARWICH</u>		
UNTIL FURTHER NOTICE		
155	Wrabness and Mistley Up	07 30 to 17 00. Earthwork. 64m. 46chs. and 64m. 15chs. Mechanical equipment in use. (85/65)
156	Parkeston West and Harwich Town Single	07 30 to 18 00. Track maintenance, track renewal and earthwork. 70 $\frac{1}{2}$ m.p. Mechanical equipment in use. (85/27)
MONDAY 13 TO WEDNESDAY 15 OCTOBER		
157	Wrabness and Manningtree East Jn Up BLOCKED	23 30 Mon and Tue to 05 30 Tue and Wed. Track maintenance, loading materials and overhead line work. Mechanical equipment in use. <u>Isolation of electrical sections 391F. Single line working over Down line.</u>
WEDNESDAY/THURSDAY 15/16 OCTOBER		
158	Manningtree East Jn and Wrabness Down BLOCKED	23 30 to 05 30. Track maintenance, overhead line work and loading materials. Mechanical equipment in use. <u>Isolation of electrical sections 392A. Single line working over Up line.</u>
THURSDAY/FRIDAY 16/17 OCTOBER		
159	Wrabness and Parkeston Goods Jn Down and Up BLOCKED	23 30 to 05 00. Loading materials. <u>Possession to be given up for passage of trains.</u>
160	Parkeston Goods Jn and Dovercourt Down/Through Siding BLOCKED	23 45 to 04 30. Overhead line work. Mechanical equipment in use. <u>Isolation of electrical sections 392FG. Possession to be given up for passage of Diesel trains.</u>

SECTION B - TEMPORARY ENGINEERING WORKS - continued

At or between	Lines affected	Remarks
---------------	----------------	---------

MANNINGTREE SOUTH JN TO HARWICH - continued

FRIDAY/SATURDAY 17/18 OCTOBER

161	Harwich Town and Parkeston Goods Jn	Single/Up BLOCKED)23 45 to 04 30. Overhead line work.)Mechanical equipment in use.) <u>Isolation of electrical sections</u>) <u>391AB. Possession to be given up</u>) <u>for passage of Diesel trains.</u>)
	Parkeston Quay Station	Platform 3 BLOCKED	

EAST SUFFOLK JN TO OULTON BROAD NORTH JN

UNTIL FURTHER NOTICE

162	Westerfield Jn and Woodbridge	Down and Up <u>Between Trains</u>	Bridgework (No. 418A). 76m. 65chs. Mechanical equipment in use. (86/28)
-----	-------------------------------	--------------------------------------	---

SATURDAY/SUNDAY 11/12 OCTOBER

163	Halesworth and Oulton Broad South	Single BLOCKED	22 15 to 11 15. Track maintenance. and track renewal. Crane and mechanical equipment in use.
-----	-----------------------------------	-------------------	--

WESTERFIELD JN TO FELIXSTOWE

UNTIL FURTHER NOTICE

164	Westerfield Jn and Derby Road	Single	08 00 to 16 00. Earthwork. 73m. 13chs. and 73 $\frac{1}{2}$ m.p. (85/61)
165	Derby Road and Felixstowe Beach Jn	Single	07 30 to 17 00. Earthwork. 82 $\frac{1}{2}$ and 83m.p. Mechanical equipment in use. (86/1)

SATURDAY/SUNDAY 11/12 OCTOBER

166	Derby Road and Felixstowe Beach Jn	All BLOCKED	22 00 to 18 00. Earthwork. Mechanical equipment in use.
-----	------------------------------------	----------------	--

SECTION B - TEMPORARY ENGINEERING WORKS - continued

At or between	Lines affected	Remarks	
<u>NORWICH TO LOWESTOFT</u>			
UNTIL FURTHER NOTICE			
167	Norwich Station	All	Track renewal, platform work and earthwork. Crane and mechanical equipment in use. (85/62)
168	Norwich Station and Trowse Lower Jn	All <u>Between Trains</u>	07 00 to 17 00. Construction work (overhead line), earthwork, track maintenance and signalling work. Points and signals disconnected. (86/7)
169	Thorpe Jn	All	08 00 to 17 00. Earthwork and track maintenance. (85/22)
170	Whitlingham Jn and Thorpe Jn	Up	07 30 to 17 00. Earthwork 1½ and 1m.p. Mechanical equipment in use. (86/13)
171	Reedham Swing Bridge	Down and Up BLOCKED	08 00 to 16 00. Bridgework (No. 1238). <u>Possession to be given up for passage of trains.</u> (86/23)
172	Oulton Broad North Jn and Lowestoft	All	08 00 to 16 00. Undertrack excavation. 23 and 23¼m.p. (86/26)

SATURDAY/SUNDAY 11/12 OCTOBER

173	Trowse Yard and Norwich	'C' line/Up Main BLOCKED Down Main/ 'W' line BLOCKED	22 00 to 06 45)Track renewal.)Mechanical equipment in 23 55 to 12 00)use. <u>22 00 Sat to</u>) <u>06 45 Possession to</u>) <u>be given up for passage</u>) <u>of 1P04 02 10</u>) <u>Liverpool Street to</u>) <u>Yarmouth over Up</u>) <u>Main/'C' line under</u>) <u>single line working.</u>) <u>06 45 to 12 00 Sun.</u>) <u>Single line working</u>) <u>over Up Main/'C'</u>) <u>line.</u>
-----	-------------------------	--	---

SECTION B - TEMPORARY ENGINEERING WORKS - continued

At or between	Lines affected	Remarks
<u>NORWICH TO LOWESTOFT - continued</u>		
SATURDAY 11 TO FRIDAY 17 OCTOBER		
174 Norwich and Whitlingham Jn	'A' and 'E' lines/Down and Up Lowestoft/Main BLOCKED)23 30 Sat to Thu to 05 00 Sun to Fri.)Construction work (overhead line) and)track maintenance. Mechanical)equipment in use. <u>Possession to be)given up for passage of trains.</u>)
Norwich Station	Platforms 4, 5 and 6 BLOCKED)))
SUNDAY 12 TO FRIDAY 17 OCTOBER		
175 Trowse Yard and Norwich Station	All BLOCKED	23 15 Sun to Thu to 05 00 Mon to Fri. Construction work (overhead line), track maintenance and track renewal. Mechanical equipment in use. <u>Possession to be given up for passage of trains.</u>
<u>WHITLINGHAM JN TO CROMER</u>		
UNTIL FURTHER NOTICE		
176 Whitlingham Jn and Wroxham	Down and Up	07 30 to 16 30. Bridgework (No. 365). 3m. 48chs. (86/6)
177 Cromer Station	Platforms 1 and 2	Platform work. (86/15)
WEDNESDAY/THURSDAY 15/16 OCTOBER		
178 Wroxham and North Walsham	Single BLOCKED	22 30 to 05 30. Track maintenance. Mechanical equipment in use.
THURSDAY/FRIDAY 16/17 OCTOBER		
179 North Walsham and Cromer	Single BLOCKED	22 30 to 05 45. Track maintenance. Mechanical equipment in use.

SECTION B - TEMPORARY ENGINEERING WORKS - continued

<u>At or between</u>	<u>Lines affected</u>	<u>Remarks</u>
<u>CROMER TO SHERINGHAM</u>		
UNTIL FURTHER NOTICE		
180 Cromer Station	Platforms 1 and 2	Platform work. (86/15)
<u>BRUNDALL JN TO YARMOUTH VIA ACLE</u>		
UNTIL FURTHER NOTICE		
181 Lingwood	Single	08 00 to 17 00. Construction work. 8m. 03chs. (86/12)
<u>BETHNAL GREEN JN TO KING'S LYNN</u>		
UNTIL FURTHER NOTICE		
182 Cambridge Heath Station	Down and Up Suburban	08 00 to 17 00. Platform work. 1m. 61chs. Mechanical equipment in use. <u>(See Section 'D')</u> . (86/24)
183 London Fields Station	Down and Up Suburban	Platform work. 2m. 35chs. Mechanical equipment in use. <u>(See Section 'D')</u> . (86/27)
184 Enfield Lock Station	Up	08 00 to 16 30. Platform work. 11m. 65chs. Mechanical equipment in use. (86/28)
185 Enfield Lock and Waltham Cross	Down and Up	07 00 to 18 00. Bridgework (No.1418C). 12m. 34chs. Crane and mechanical equipment in use. (85/59)
186 Bishops Stortford (Country end) and Stansted	Down and Up Main BLOCKED to electric trains	Overhead line work. <u>Isolation of electrical sections 427, 428 (buffer section)</u> . (85/41)
187 Bishops Stortford and Cambridge (North)	All	07 00 to 18 00. Construction work (overhead line). Mechanical equipment in use. (85/21)

SECTION B - TEMPORARY ENGINEERING WORKS - continued

At or between	Lines affected	Remarks
---------------	----------------	---------

BETHNAL GREEN JN TO KING'S LYNN - continued

UNTIL FURTHER NOTICE - continued

188	Whittlesford Station	Down	Platform work 49m. 02chs. Mechanical equipment in use. <u>Until 08 00 Monday 13 October.</u> (86/21)
189	Whittlesford Station	Down and Up	Platform work. 49m. 02chs. Mechanical equipment in use. <u>From 08 00 Monday 13 October.</u> (86/29)
190	Shelford	Down and Up	Platform work. 52m. 36chs. Mechanical equipment in use. (86/6)
191	Chesterton Jn and Milton Fen LC	Down and Up	07 30 to 18 00. Bridgework (No. 1550B). 58m. 63chs. Mechanical equipment in use. (86/24)

SATURDAY 11 OCTOBER

192	Bethnal Green (Country End) and Bury Street Jn	Down and Up Suburban/ Down and Up BLOCKED to electric trains	00 45 to 05 00. In connection with overhead line work between Hackney Downs North Jn and Seven Sisters. <u>Isolation of electrical sections 401 and 402. Electric trains to travel over Fast lines and to be diverted via Clapton.</u>
193	Whittlesford Crossovers and Great Chesterford	Up Main	08 00 to 18 00. Signalling work.

SECTION B - TEMPORARY ENGINEERING WORKS - continued

At or between	Lines affected	Remarks
---------------	----------------	---------

BETHNAL GREEN JN TO KING'S LYNN - continued

SATURDAY/SUNDAY 11/12 OCTOBER

194	Stanstead and Audley End	Up	22 25 to 08 30)Construction work) (overhead line). 33%) and 4 1/4 m.p. Mechanical) equipment in use.) Possession to be given) up for passage of 1P04) 02 10 Liverpool Street) to Yarmouth and 1H02) 03 10 Liverpool Street) to King's Lynn over) Down line.
		BLOCKED		
		Down	23 50 to 09 00	
		BLOCKED		
195	Audley End and Great Chesterford	Up	22 25 to 08 30)Construction work) (overhead line)) and trimming lineside) vegetation. 4 1/2 and) 4 5/8 m.p. Mechanical) equipment in use.) Possession to be given) up for passage of 1P04) 02 10 Liverpool Street) to Yarmouth and 1H02) 03 10 Liverpool Street) to King's Lynn over) Down line.
		BLOCKED		
		Down	23 50 to 09 00	
		BLOCKED		

SATURDAY 11 AND SUNDAY 12 OCTOBER

196	Bethnal Green (Country End) and Hackney Downs	Down and Up	08 00 to 22 00 daily. Platform work (Cambridge Heath Station). Mechanical equipment in use. <u>Isolation of electrical sections</u> <u>313A, 314B. Trains to travel over</u> <u>Fast lines.</u>
		Suburban BLOCKED	
197	Cheshunt Jn and Bishops Stortford	All	06 00 to 17 00 daily. Signalling work.

SUNDAY 12 OCTOBER

198	Hackney Downs North Jn and Clapton Jn	Down and Up BLOCKED	00 50 to 06 30. Track maintenance. 3m. 08chs. and 3 1/2 m.p. <u>Trains</u> <u>diverted via Southbury.</u>
-----	--	------------------------	---

SECTION B - TEMPORARY ENGINEERING WORKS - continued

At or between	Lines affected	Remarks
<u>BETHNAL GREEN JN TO KING'S LYNN - continued</u>		
SUNDAY 12 OCTOBER - continued		
199 Clapton Jn and Cheshunt Jn	Down and Up Main BLOCKED to electric trains	00 01 to 23 59. In connection with engineering work between Tottenham South Jn and Cheshunt Jn. <u>Isolation of electrical sections 411 and 412. Electric trains diverted via Southbury.</u>
200 Tottenham South Jn and Cheshunt Jn	Down and Up Main BLOCKED	08 00 to 16 00. Track maintenance and loading materials. Crane and mechanical equipment in use. <u>Trains diverted via Southbury.</u>
201 Cheshunt Station and Broxbourne	Down Main BLOCKED Up Main BLOCKED	00 10 to 08 15) Track maintenance,)reballasting and 00 10 to 18 00) overhead line work.) Mechanical equipment in use. <u>00 10 to 08 15</u>) <u>Isolation of electrical sections 413G, 414C.</u>) <u>Possession to be given up for passage of 1P04</u>) <u>02 10 Liverpool Street to Yarmouth, 1H02 03 10</u>) <u>Liverpool Street to King's Lynn and 1H04</u>) <u>04 00 Liverpool Street to Harlow Town over</u>) <u>Down Main line.</u>) <u>08 15 to 18 00 Sun.</u>) <u>Isolation of electrical sections 413G. Single</u>) <u>line working over Down</u>) <u>Main line.</u>
202 Great Chesterford and Whittlesford Crossovers	Down Main	08 00 to 18 00. Signalling work.
203 Shepreth Branch Jn and Coldham Lane Jn	All BLOCKED	00 30 to 08 00. Construction work (overhead line). 53 $\frac{1}{2}$ and 56 $\frac{1}{2}$ m.p. Mechanical equipment in use. <u>Possession to be given up for passage of trains.</u>

SECTION B - TEMPORARY ENGINEERING WORKS - continued

At or between	Lines affected	Remarks
<u>BETHNAL GREEN JN TO KING'S LYNN - continued</u>		
MONDAY 13 OCTOBER		
204 Bethnal Green (London End) and Seven Sisters	Down and Up Suburban/ Down and Up BLOCKED to electric trains	01 15 to 04 45. In connection with overhead line work between Bethnal Green and Hackney Downs. <u>Isolation of electrical sections 313, 314, 401DE, 402ABC. Electric trains to travel over Fast lines and to be diverted via Clapton.</u>
205 Bethnal Green (Country End) and Hackney Downs	Down and Up Suburban BLOCKED	01 15 to 04 45. Overhead line work. <u>Trains to travel over Fast lines. Possession to be given up for passage of 5C02 00 55 Cambridge to Liverpool Street (diverted) crossing from Up Suburban to Up Fast line at Hackney Downs (London End).</u>
MONDAY/TUESDAY 13/14 OCTOBER		
206 Harlow Mill and Harlow Town	Up BLOCKED	23 00 to 05 30. Track maintenance. Mechanical equipment in use. <u>Single line working over Down line.</u>
MONDAY 13 TO FRIDAY 17 OCTOBER		
207 Audley End and Great Chesterford	Down BLOCKED	09 30 to 15 30 daily. Construction work (overhead line). 4½ and 45½m.p. <u>Single line working over Up line.</u>
208 Shepreth Branch Jn and Coldham Lane Jn	All <u>Between Trains</u>	08 00 to 16 00 daily. Construction work (overhead line). 53½ and 56¾m.p. Mechanical equipment in use.
209 Cambridge (North) and Coldham Lane Jn	Down Goods Loop North BLOCKED Down Main	08 00 to 16 00 daily. Earthwork. 56 and 56¾m.p. Mechanical equipment in use.
TUESDAY 14 OCTOBER		
210 Bethnal Green and Hackney Downs	Down and Up Fast BLOCKED	10 45 to 15 00. Overhead line work. <u>Isolation of electrical sections 315, 316, 407C, 408A. Trains to travel over Suburban lines.</u>

SECTION B - TEMPORARY ENGINEERING WORKS - continued

At or between	Lines affected	Remarks
---------------	----------------	---------

BETHNAL GREEN JN TO KING'S LYNN - continued

TUESDAY/WEDNESDAY 14/15 OCTOBER

211 Harlow Town and Harlow Mill	Down BLOCKED	23 15 to 04 20. Track maintenance. Mechanical equipment in use. <u>Single line working over Up line.</u>
---------------------------------	-----------------	--

TUESDAY 14 TO FRIDAY 17 OCTOBER

212 Broxbourne (Country End) and Cheshunt Station	Up Main BLOCKED	00 01 to 04 15 daily. Track maintenance, unloading materials and overhead line work. Mechanical equipment in use. <u>Isolation of electrical sections 413FG. Single line working over Down Main line.</u>
---	--------------------	---

READING LANE JN TO NAVARINO ROAD JN (GRAHAM ROAD CURVE)

SATURDAY 11 AND SUNDAY 12 OCTOBER

213 Reading Lane Jn and Navarino Road Jn	Single BLOCKED to electric trains	08 00 to 22 00 daily. In connection with engineering work between Bethnal Green and Hackney Downs. <u>Isolation of electrical sections 314C.</u>
--	---	--

MONDAY 13 OCTOBER

214 Reading Lane Jn and Navarino Road Jn	Single BLOCKED to electric trains	01 15 to 04 45. In connection with overhead line work between Bethnal Green and Hackney Downs. <u>Isolation of electrical sections 314C.</u>
--	---	--

HACKNEY DOWNS NORTH JN TO ENFIELD TOWN

SATURDAY 11 OCTOBER

215 Bethnal Green (Country End) and Bury Street Jn	Down and Up Suburban/ Down and Up BLOCKED to electric trains	00 45 to 05 00. In connection with overhead line work between Hackney Downs North Jn and Seven Sisters. <u>Isolation of electrical sections 401 and 402. Electric trains to travel over Fast lines and to be diverted via Clapton.</u>
--	--	--

SECTION B - TEMPORARY ENGINEERING WORKS - continued

At or between	Lines affected	Remarks
---------------	----------------	---------

HACKNEY DOWNS NORTH JN TO ENFIELD TOWN - continued

SATURDAY 11 OCTOBER - continued

216	Hackney Downs North Jn and Seven Sisters	Down and Up BLOCKED	00 45 to 05 00. Overhead line work. Mechanical equipment in use. <u>Trains diverted via Clapton.</u>
-----	--	------------------------	--

MONDAY 13 OCTOBER

217	Bethnal Green (London End) and Seven Sisters	Down and Up Suburban/ Down and Up BLOCKED to electric trains	01 15 to 04 45. In connection with overhead line work between Bethnal Green and Hackney Downs. <u>Isolation of electrical sections 313, 314, 401DE, 402ABC. Electric trains to travel over Fast lines and to be diverted via Clapton.</u>
-----	--	--	---

BURY STREET JN TO CHESHUNT

SATURDAY 11 AND SUNDAY 12 OCTOBER

218	Bury Street Jn and Cheshunt Jn	Down and Up	06 00 to 17 00 daily. Signalling work.
-----	--------------------------------	-------------	--

CLAPTON JN TO CHINGFORD

SUNDAY 12 OCTOBER

219	Chingford	All	08 00 to 17 00. Signalling work.
-----	-----------	-----	----------------------------------

BROXBOURNE JN TO HERTFORD EAST

UNTIL FURTHER NOTICE

220	Rye House and St. Margarets	Down and Up	08 00 to 18 00. Bridgework (No. 2035A). 19m. 66chs. Mechanical equipment in use.
-----	-----------------------------	-------------	--

(85/60)

SUNDAY 12 OCTOBER

221	Broxbourne Jn and Hertford East	All BLOCKED	00 30 to 06 30. Platform work and construction work (St. Margarets Station). Mechanical equipment in use. <u>Isolation of electrical sections 434 and 435.</u>
-----	---------------------------------	----------------	--

SECTION B - TEMPORARY ENGINEERING WORKS - continued

At or between	Lines affected	Remarks
---------------	----------------	---------

BROXBOURNE JN TO HERTFORD EAST - continued

TUESDAY 14 TO FRIDAY 17 OCTOBER

222	Broxbourne Jn and Hertford East	All BLOCKED	00 35 to 04 50 daily. Platform work and construction work (St. Margarets Station). Mechanical equipment in use. <u>Isolation of electrical sections 434 and 435.</u>
-----	---------------------------------	-------------	--

COLDHAM LANE JN TO HAUGHLEY JN

UNTIL FURTHER NOTICE

223	Bury St. Edmunds Station	Down	08 00 to 15 00. Repairs to platform awnings. (86/18)
224	Bury St. Edmunds and Elmswell	Down and Up	08 00 to 18 00. Drainage. 29m. 78chs. Mechanical equipment in use. (86/12)

SATURDAY/SUNDAY 11/12 OCTOBER

225	Bury St. Edmunds and Haughley Jn	Up BLOCKED Down BLOCKED	22 00 to 13 15) Track maintenance and) track renewal. Crane 23 15 to 15 30) and mechanical) equipment in use.) <u>13 15 to 15 30 Sun</u>) <u>Single line working</u>) <u>over Up line.</u>
-----	----------------------------------	----------------------------	---

SUNDAY 12 OCTOBER

226	Kennett and Bury St. Edmunds	Down and Up BLOCKED	07 00 to 13 40. Loading materials 18 ³ / ₄ and 28 ³ / ₄ m.p. Mechanical equipment in use.
-----	------------------------------	---------------------	--

CHIPPENHAM JN TO ELY DOCK JN

SATURDAY/SUNDAY 11/12 OCTOBER

227	Soham and Ely Dock Jn	Single/Down and Up BLOCKED	22 15 to 08 00. Track maintenance. 7 ³ / ₄ and 12m.p. Mechanical equipment in use.
-----	-----------------------	----------------------------	---

SECTION B - TEMPORARY ENGINEERING WORKS - continued

At or between	Lines affected	Remarks
---------------	----------------	---------

MARCH EAST JN TO WISBECH

SATURDAY 11 TO MONDAY 13 OCTOBER

228	Whitemoor Jn and Wisbech Goods Yard	Single BLOCKED Single <u>Between Trains</u>	00 01 Sat to 03 00 Mon) Bridgework.)88m.p. 03 00 to 07 00 Mon) Mechanical)equipment in)use.
-----	---	--	---

ELY NORTH JN TO TROWSE LOWER JN

UNTIL FURTHER NOTICE

229	Thetford and Lakenheath	Up	08 00 to 16 00. Track maintenance. 87% and 85% m.p. (86/24)
230	Wymondham and Hethersett	Down and Up <u>Between Trains</u>	07 30 to 18 00. Bridgework, earthwork and construction work. 115m. 65chs. and 117m. 69chs. Cranes and mechanical equipment in use. (86/18)
231	Wymondham and Trowse Lower Jn	Down and Up	07 30 to 16 00. Signalling work. (85/24)
232	Hethersett and Trowse Lower Jn	Down and Up	07 30 to 16 00. Bridgework (Nos.1638, 1640, 1640A and 349). 121m. 17chs. and 122m. 32chs. (86/22)

*FRIDAY/SATURDAY 10/11 OCTOBER

233	Wymondham and Hethersett	Down and Up BLOCKED	23 00 to 06 00. Bridgework (No. 1628A). Crane and mechanical equipment in use.
-----	-----------------------------	------------------------	--

SATURDAY 11 TO SUNDAY 12 OCTOBER

234	Hethersett and Trowse Lower Jn	Down and Up	07 00 Sat to 20 00 Sun. Signalling work (Keswick LC).
-----	--------------------------------------	-------------	--

SECTION B - TEMPORARY ENGINEERING WORKS - continued

At or between	Lines affected	Remarks
---------------	----------------	---------

ELY NORTH JN TO TROWSE LOWER JN - continued

SATURDAY/SUNDAY 11/12 OCTOBER

235	Lakenheath and Brandon	Down and Up BLOCKED	23 00 to 07 30. Loading materials. 82½ and 86¼m.p. Mechanical equipment in use. <u>Possession to be given up for passage of trains.</u>
236	Attleborough	Down and Up BLOCKED	22 30 to 16 00. Level crossing road repairs 108m. 19chs. Crane and mechanical equipment in use. <u>22 30 Sat to 07 30 Possession to be given up for passage of 1P04 02 10 Liverpool Street to Yarmouth over Down line. 07 30 to 16 00 Sun Possession to be given up for passage of trains.</u>
237	Hethersett and Trowse Lower Jn	Up BLOCKED Down BLOCKED	23 00 to 07 15) Bridgework (Nos. 1640 and 1640A). 121¾m.p. 23 00 to 16 00) Crane and mechanical equipment in use. 23 00 Sat to 07 15. Possession to be given up for passage at 1P04 02 10 Liverpool Street to Yarmouth over Up line under single line working. 07 15 to 16 00 Sun. Single line working over Up line.

MONDAY 13 TO SATURDAY 18 OCTOBER

238	Wymondham and Hethersett	Down and Up BLOCKED	23 00 Mon to Fri to 06 00 Tue to Sat. Bridgework (No. 1628A). Crane and mechanical equipment in use.
-----	--------------------------	------------------------	--

WYMONDHAM TO NORTH ELMHAM

UNTIL FURTHER NOTICE

239	Wymondham and North Elmham	Single	08 00 to 16 00. Trimming lineside vegetation. ¼ and 6m.p. Mechanical equipment in use.
-----	----------------------------	--------	--

SECTION B - TEMPORARY ENGINEERING WORKS - continued

<u>At or between</u>	<u>Lines</u>	<u>affected</u>	<u>Remarks</u>
<u>FENCHURCH STREET TO SHOEBURYNESS</u>			
UNTIL FURTHER NOTICE			
240	Fenchurch Street Station	All	Construction/demolition work. Mechanical equipment in use. (84/38)
241	Fenchurch Street and Stepney East	All	Construction work, and in connection with engineering work (Docklands Light Railway). Mechanical equipment in use. (<u>See Section 'D'</u>). (86/25)
242	Fenchurch Street and Gas Factory Jn	All	08 00 to 17 00. Signalling work. (86/1)
243	East Ham	Down and Up	Construction work. Mechanical equipment in use. (83/51)
244	East Ham and Barking (London End)	Down and Up	Erecting scaffolding in connection with bridge No. 66B. (85/8)
245	Leigh-on-Sea and Benfleet	Up	Sea wall work. (85/34)
246	Leigh-on-Sea	Down	09 00 to 16 00. Demolition work. Mechanical equipment in use. (85/60)
247	Westcliff-on- Sea	Down	09 00 to 16 00. Demolition work. Mechanical equipment in use. (85/60)

FRIDAY/SATURDAY 10/11 OCTOBER

248	Fenchurch Street	All BLOCKED	21 15 to 06 00. Construction work. Mechanical equipment in use.
249	Fenchurch Street and Gas Factory Jn	All BLOCKED	21 15 to 06 00. Repairs to platform awnings (Stepney East Station), construction work and painting Stepney East Station. <u>Isolation of electrical sections 501, 502, 503 and 504.</u>

SECTION B - TEMPORARY ENGINEERING WORKS - continued

At or between	Lines affected	Remarks
<u>FENCHURCH STREET TO SHOEBURYNESS - continued</u>		
FRIDAY/SATURDAY 10/11 OCTOBER - continued		
250 East Ham (London End) and Barking Station (London End)	Down and Up Main BLOCKED	21 15 to 05 15. Bridgework (No. 66B). Crane and mechanical equipment in use. <u>Isolation of electrical sections 510A, 511E.</u>
SATURDAY 11 OCTOBER		
251 Upminster and Pitsea	Down and Up BLOCKED	01 15 to 04 25. Overhead line work. Crane and mechanical equipment in use. <u>Isolation of electrical sections 517, 518, 519 and 520. Trains diverted via Grays.</u>
SUNDAY 12 OCTOBER		
252 Forest Gate Jn and Barking Station (Country End)	All BLOCKED to electric trains	00 50 to 20 00. In connection with engineering work. <u>Isolation of electrical sections 512 and 513.</u>
253 Barking Tilbury Line Jn West and Barking Station (Country End)	Down and Up Tilbury BLOCKED	00 50 to 20 00. Bridgework (No.18) and track maintenance. Mechanical equipment in use. <u>Possession to be given up for passage of Engineers' trains.</u>
254 Barking Station	Platform 4 (Down Main) BLOCKED	00 50 to 06 15. Track maintenance. Mechanical equipment in use.
255 Laindon and Pitsea	Down and Up BLOCKED	01 15 to 07 00. Track maintenance. <u>Trains diverted via Grays.</u>
256 Pitsea and Southend Central	Down BLOCKED Up BLOCKED	01 35 to 19 00)Track maintenance,)track renewal, 01 55 to 19 00)reballasting, unloading)rails, overhead line)work and painting)Benfleet Station.)Mechanical equipment)in use. <u>01 55 to)19 00 Isolation of)electrical sections)521AB, 522CDE, 523,)524, 525BC, 526AB.</u>

SECTION B - TEMPORARY ENGINEERING WORKS - continued

At or between	Lines affected	Remarks
<u>FENCHURCH STREET TO SHOEBURYNESS - continued</u>		
SUNDAY 12 OCTOBER - continued		
257 Southend Central and Shoeburyness	Up BLOCKED Down BLOCKED	01 05 to 06 20)Overhead line work)and unloading rails. 01 05 to 06 45)Mechanical equipment)in use. <u>01 05 to</u>) <u>05 45 Isolation of</u>) <u>electrical sections</u>) <u>525A, 526C, 527, 528</u>) <u>and 529.</u>
MONDAY 13 OCTOBER		
258 Pitsea and Southend Central	Down and Up BLOCKED	01 45 to 04 20. Overhead line work. <u>Isolation of electrical sections 523,</u> <u>524, 525BC, 526AB.</u>
MONDAY 13 TO WEDNESDAY 15 OCTOBER		
259 Leigh-on-Sea and Pitsea	Up BLOCKED	23 30 Mon and Tue to 04 30 Tue and Wed. Track maintenance. <u>Single line</u> <u>working over Down line.</u>
MONDAY 13 TO FRIDAY 17 OCTOBER		
260 Leigh-on-Sea Station	Platform 1 (Down Main) BLOCKED	10 00 to 15 30 daily. Platform work. Mechanical equipment in use. <u>Down</u> <u>trains to travel over No.2 Platform</u> <u>(Reversing) line.</u>
MONDAY 13 TO SATURDAY 18 OCTOBER		
261 Fenchurch Street	All BLOCKED	21 15 Mon to Fri to 06 00 Tue to Sat. Construction work. Mechanical equipment in use.
262 Fenchurch Street and Gas Factory Jn.	All BLOCKED	21 15 Mon to Fri to 06 00 Tue to Sat. Repairs to platform awnings (Stepney East Station), construction work and painting Stepney East Station. <u>Isolation of electrical</u> <u>sections 501, 502, 503 and 504.</u>
263 East Ham (London End) and Barking Station (London End)	Down and Up Main BLOCKED	21 15 Mon to Fri to 05 15 Tue to Sat. Bridgework (No. 66B). Crane and mechanical equipment in use. <u>Isolation of electrical sections 510A,</u> <u>511E.</u>

SECTION B - TEMPORARY ENGINEERING WORKS - continued

At or between	Lines affected	Remarks
---------------	----------------	---------

FENCHURCH STREET TO SHOEBURYNESSE - continued

TUESDAY 14 TO FRIDAY 17 OCTOBER

264	Upminster and Laindon	Down and Up BLOCKED	01 15 to 04 25 daily. Overhead line work. Crane and mechanical equipment in use. <u>Trains diverted via Grays.</u>
265	Upminster and Pitsea	Down and Up BLOCKED to electric trains	01 15 to 04 25 daily. In connection with overhead line work between Upminster and Laindon. <u>Isolation of electrical sections 517, 518, 519 and 520. Electric trains diverted via Grays.</u>
266	Laindon and Pitsea	Down and Up BLOCKED	01 15 to 04 25 daily. Track maintenance. Mechanical equipment in use. <u>Trains diverted via Grays.</u>

WEDNESDAY 15 TO FRIDAY 17 OCTOBER

267	Fenchurch Street Station	Platforms 3 and 4 BLOCKED	10 25 and 15 45 daily. Construction work. Mechanical equipment in use. <u>Isolation of electrical sections 501D, 502A. Trains to be replatformed as necessary.</u>
-----	--------------------------	------------------------------	--

UPPER HOLLOWAY TO BARKING, TILBURY LINE JN WEST

UNTIL FURTHER NOTICE

268	Upper Holloway and Crouch Hill Station	Down and Up	Earthwork. 3m 41chs. and 3m 43chs. Mechanical equipment in use. (85/64)
269	Wanstead Park Station	Up	08 00 to 16 00. Platform work. (See Section 'D'). (85/50)
270	Woodgrange Park and Barking Station Jn	Down and Up <u>Between Trains</u>	07 30 to 18 00. Bridgework (No. 6). 12m. 26chs. Crane and mechanical equipment in use. (85/62)
271	Woodgrange Park and Barking Tilbury Line Jn West	Down and Up	Erecting scaffolding in connection with bridge No. 14A. (85/8)

SECTION B - TEMPORARY ENGINEERING WORKS - continued

At or between	Lines affected	Remarks
<u>UPPER HOLLOWAY TO BARKING, TILBURY LINE JN WEST - continued</u>		
SUNDAY 12 OCTOBER		
272 Upper Holloway and South Tottenham West Jn	Down and Up BLOCKED	00 45 to 07 45. Track maintenance. Mechanical equipment in use.
273 Harringay Park Jn and South Tottenham West Jn	Down and Up BLOCKED	07 45 to 12 45. Track maintenance. Mechanical equipment in use.
274 Forest Gate Jn and Barking Station (Country End)	All BLOCKED to electric trains	00 50 to 20 00. In connection with engineering work. <u>Isolation of electrical sections 512 and 513.</u>
SUNDAY 12 TO MONDAY 13 OCTOBER		
275 Woodgrange Park Jn and Barking Tilbury Line Jn West	Down and Up BLOCKED	00 50 Sun to 04 00 Mon. Bridgework (No.14A). Crane and mechanical equipment in use. <u>Possession to be given up for passage of Diesel trains.</u>
SUNDAY/MONDAY 12/13 OCTOBER		
276 Forest Gate Jn and Barking Tilbury Line Jn West	Down and Up BLOCKED to electric trains	20 00 to 04 00. In connection with engineering work. <u>Isolation of electrical sections 512AB, 513EF.</u>
<u>BARKING, TILBURY LINE JN EAST TO TILBURY RIVERSIDE</u>		
UNTIL FURTHER NOTICE		
277 Dagenham Dock Station	Down and Up	08 00 to 17 00. Construction work. Mechanical equipment in use. (85/14)
278 Rainham Station	Down and Up	08 00 to 17 00. Construction work. Mechanical equipment in use. (85/14)

SECTION B - TEMPORARY ENGINEERING WORKS - continued

At or between	Lines	Remarks
	affected	

BARKING, TILBURY LINE JN EAST TO TILBURY RIVERSIDE - continued

UNTIL FURTHER NOTICE - continued

279 Purfleet Station	Down and Up	09 00 to 16 00. Platform work. Mechanical equipment in use. (85/61)
-------------------------	-------------	---

SUNDAY 12 OCTOBER

280 Barking Tilbury All Line Jn East and West Thurrock Jn.	BLOCKED	00 35 to 07 00. Track maintenance. Mechanical equipment in use.
--	---------	--

SECTION C

SIGNALLING AND PERMANENT WAY ALTERATIONS

* * Items marked thus will not appear in future issues and a note must be
* taken of them by all concerned.

DETAILS OF WORK REFERRED TO IN SECTION B

NIL

DETAILS OF WORK ALREADY CARRIED OUT

NEW HALL

The Up Loop has been taken out of use Until Further Notice.

(UFN)

HATFIELD PEVEREL

The facing and trailing crossovers are out of use until further notice.

(UFN)

DISS-TIVETSHALL-SWAINSTHORPE

Diss and Tivetshall Signalboxes have been abolished and new colourlight signalling commissioned. Full details are published in Supplementary Signalling Notice No. 145 and all concerned should be in possession of a copy of this Notice.

(31)

* * GISSING LEVEL CROSSING AT 98m 57chs (between Diss and Tivetshall)
*

The level crossing gates have been removed and the crossing converted to one with automatic half-barriers.

Telephone communication has been provided between the crossing and Diss signalbox (previously to Tivetshall).

Working in wrong direction

The barriers have been equipped to work automatically when approached in the reverse direction and for this purpose a combined St. Andrew's Cross/50 m.p.h. speed restriction sign has been provided 954 yards from the crossing applicable to each rail approach in the wrong direction.

(29)

SECTION C - SIGNALLING AND PERMANENT WAY ALTERATIONS - continuedDETAILS OF WORK ALREADY CARRIED OUT - continued* * NEWTON FLOTMAN LEVEL CROSSING AT 108m. 19chs. (between Tivetshall and Swainsthorpe)

The level crossing gates have been removed and the crossing converted to one with Automatic half-barriers.

The crossing will be closed to road traffic and the barriers secured in the lowered position until the associated road works are completed when the barriers will be fully commissioned.

Telephone communication has been provided between the level crossing and Swainsthorpe signalbox.

Working in wrong direction

The automatic half-barriers have been equipped to work automatically when approached in the wrong direction, and for this purpose a combined St. Andrews Cross/50 m.p.h. speed restriction sign has been provided 1,003 yards from the crossing applicable to each rail approach in the wrong direction.

(29)

TIVETSHALL

The trailing crossover has been secured out of use pending removal and the associated shunting signals abolished.

(30)

* * TROWSE UPPER JUNCTION AND TROWSE LOWER JUNCTION

*

Trowse Upper Junction

Trowse Upper Junction Signal Box, together with all signals worked therefrom has been abolished. All points previously worked therefrom including the Siding line to Victoria Goods Depot have been secured out of use pending removal.

(The catch points are unaffected at this stage).

The Block Section is now between Swainsthorpe and Trowse Lower Junction.

SECTION C - SIGNALLING AND PERMANENT WAY ALTERATIONS - continuedDETAILS OF WORK ALREADY CARRIED OUT - continued** TROWSE UPPER JUNCTION AND TROWSE LOWER JUNCTION - continued

*

Trowse Lower JunctionSignalling Alterations

A new Trowse Lower Junction Down Main Distant plated TL47 (3-aspect colour light signal exhibiting Yellow or Green aspect only at this stage) has been provided 1,500 yards before reaching the Trowse Lower Junction Down Home signal TL45. (This new Distant signal is 700 yards further from TL45 signal than was the former Trowse Upper Junction Down Main Starting signal TU20 which incorporated the Trowse Lower Junction Down Distant).

An Automatic Warning System track inductor has been provided in conjunction with TL47 new colour light Distant signal.

(29)

TROWSE SWING BRIDGE

The following points have been secured out of use pending removal :-

Trailing Crossover between the Down and Up Main Lines.

Facing connection - Down Main to the Temporary Goods Single Line to Crown Point and Whitlingham Junction (Reinstated Wensum Curve Single Line).

All associated ground shunting signals have been abolished.

The temporary Goods Single Line has been taken out of use and has reverted to being the Crown Point Depot "Dead End" Siding No.1A. A temporary Stop-Block has been provided adjacent to the site of the former permanent red colour light signal TSB3 which has also been abolished.

(30)

THORPE JUNCTION

A new Engine Neck Siding has been brought into use adjacent to and connected to Line 'A/E' via new points giving access at the Norwich Station end.

The new Siding line is located between Carrow Road Bridge and the Up/Down Lowestoft Line Crossovers, and provides standage for stabling up to the equivalent of two main line locomotives (approximately 50 yards standage).

A new "Exit" position light shunting signal plated NO 1779 has been provided at the trap points of the new Engine Neck Siding and a 2-way stencil-type route indicator has been provided. A telephone communicating with Norwich Station signal box has been provided adjacent to NO 1779 signal.

SECTION C - SIGNALLING AND PERMANENT WAY ALTERATIONS - continuedDETAILS OF WORK ALREADY CARRIED OUT - continuedTHORPE JUNCTION - continuedAdditional routes on existing signals

The existing signals now applying towards the new Engine Neck Siding and the route indications on new NO 1779 Signal are included in the Description of Signals below.

Main Signals

<u>Line</u>	<u>Signal</u>	<u>Aspect</u> (PL = Position Light)	<u>Route</u> <u>Indication</u>	<u>Application</u> <u>Towards</u>
Platforms 1, 2, 3, 4, 5, 6	NO 574/576 578/580/584 586	PL	'N'	Engine Neck Sidings.
Jubilee Siding	NO 588	PL	'N'	"
<u>Position Light Signals</u>				
Middle Siding	NO 1792		'N'	"
Engine Neck Siding	NO 1779		'C'	Line C, Signal No. 1785.
			'E'	Line E Signal No. 1787. (30)

* * THORPE JUNCTION

*

Line 'A'/'E' has been realigned nearer to Line 'B', between Carrow Road Bridge and the Up/Down Lowestoft lines crossovers at Thorpe Junction. The associated redundant trap points and sand-drag have been removed.

(29)

TEMPLE MILLS YARD

Manor Sidings, and Fans A and B, together with all associated switches and crossings (excluding any running line connections), have been secured out of use pending removal.



(31)

SECTION C - SIGNALLING AND PERMANENT WAY ALTERATIONS - continuedDETAILS OF WORK ALREADY CARRIED OUT - continuedWESTERFIELD

The notice board at the Lowestoft end of the Down Platform worded, "STOP - OBTAIN TOKEN AND PERMISSION TO PROCEED", has been repositioned 15 yards nearer to the signal box.

(30)

* * UFFORD LEVEL CROSSING AT 81M. 60CHS. (East Suffolk Line)

The combined St. Andrews Cross/speed restrictions sign  on the Up approach to Ufford level crossing has been replaced by an  sign 476 yards before reaching the crossing.

(29)

TRIMLEY

The Up Passenger Platform Loop has been taken out of use and the Down Platform line has become the Single Line (Up/Down Platform).

The points at each end of the Loop have been secured out of use in the normal position for through running along the Single line. (The points at the Felixstowe end of the Loop have been secured out of use pending removal).

Signalling Alterations

The Up Platform Loop Starting Signal is now applicable to the Single line.

The Up Single line Home Signal now applies along the Single line towards the Up/Down Platform.

(30)

CAMBRIDGE - COLDHAM LANE DEPOT CARRIAGE SIDINGS

New trap points have been brought into use at the North end of No. 4 Carriage Siding at 56 $\frac{1}{2}$ mp in Coldham Lane Depot.

The new trap points and the adjacent spring points connecting No.4 Carriage Siding to Nos. 4 and 5 Diesel Sidings are now operated from a new single-lever ground frame, the normal position of which sets the former spring points in Nos. 4 and 5 Diesel Sidings towards Coldham Lane Depot exit line Position Light Signal No.740 and the new trap points in the open trap position.

The ground frame lever is maintained locked in the normal position by a padlock, the key to which is held by the Carriage Sidings/Yard Supervisor. Telephone communication has been provided between the new ground frame and Cambridge Signalbox.

SECTION C - SIGNALLING AND PERMANENT WAY ALTERATIONS - continuedDETAILS OF WORK ALREADY CARRIED OUT - continuedCAMBRIDGE - COLDHAM LANE DEPOT CARRIAGE SIDINGS - continued

The "STOP TELEPHONE" notice board at the North end of No.4 Carriage Siding and the associated telephone have been abolished. A new notice board worded "STOP FOR ORDERS" has been provided immediately South of the new trap points in No.4 Carriage Siding.

(30)

LITTLEPORT

The Down Distant signal No. 25 has been replated No. 24R.

(31)

BETWEEN READING LANE JN AND NAVARINO ROAD JN

A 10 m.p.h. Permanent Speed Restriction, applicable to Down trains only, has been IMPOSED on the SINGLE line between 2m 55chs (Reading Lane Jn - including through Reading Lane Jn) and 2m 71chs.

The Maximum Permissible Speed, applicable to DOWN trains over the remaining portion of the SINGLE line between 2m 71chs and Navarino Road Jn has been INCREASED to 30 m.p.h. (See Section 'D').

(31)

FOBBING LEVEL CROSSING 30m 34chs (between Stanford-le-Hope and Pitsea)

The crossing has been converted to automatic half-barriers. Fobbing Gate Box has been abolished.

Telecommunication has been provided between the crossing and Pitsea Signalbox.

Alterations to signalling ('PJ' denotes prefix of Pitsea Signalbox)

Down Tilbury

Semi-automatic signal F3 (level crossing protecting signal) and its associated A.W.S. equipment has been abolished.

PJ22 automatic signal (on the approach to F3) now displays Red or Green aspect only.

Up Tilbury

Level crossing protecting signal F2 now displays Yellow or Green aspect only and functions as Up Distant. This signal has been replated PJ27R. (The semi-auto plate has been removed).

Signal PJ23 (on the approach side of PJ27R signal, former F2) now displays Red or Green aspect only.

(30)

SECTION D

GENERAL INSTRUCTIONS AND NOTICES

A thick vertical line denotes new or amended items.

** Items marked thus will not appear in future issues and a note must be taken of them by all concerned.
*

EASTERN REGION SECTIONAL APPENDIX (SOUTHERN AREA)

TABLE A : DETAILS OF RUNNING LINES

Running Lines and Signalling System	Location	M. Ch.	Permanent Speed Restrictions		Remarks
			Down m.p.h.	Up m.p.h.	
<p><u>LIVERPOOL STREET TO NORWICH</u></p> <p>Page 57 (Page 23, SD PON)</p> <p>At Colchester (CO)</p> <p><u>Amend</u> 'Remarks' column entry to read:-</p>					<p>Colchester (CO) signal box area between Colchester and Flordon.</p>

SE-51

SECTION D - GENERAL INSTRUCTIONS AND NOTICES - continued

EASTERN REGION SECTIONAL APPENDIX (SOUTHERN AREA) - continued

Running Lines and Signalling System	Location	M. Ch.	Permanent Speed Restrictions		Remarks
			Down m.p.h.	Up m.p.h.	
<u>LIVERPOOL STREET TO NORWICH - continued</u>					
Page 60 (Page 23, SD PON)					
At Haughley LC (AHB)					
Amend 'Remarks' column entry to read -					
Pages 60 and 61 (Page 24, SD PON)					
Delete all details between Mellis LC (AHB-X) and Swainsthorpe and substitute:-					
	Mellis LC (AHB-X)	91 34	<u>X50</u>	<u>X50</u>	<u>Approaching level crossing in wrong direction.</u> Telephone to Colchester signal box at 92m. 77chs. (Signal CO 424R).

SE-52

SECTION D - GENERAL INSTRUCTIONS AND NOTICES - continued

EASTERN REGION SECTIONAL APPENDIX (SOUTHERN AREA) - continued

Running Lines and Signalling System	Location	M. Ch.	Permanent Speed Restrictions		Remarks
			Down m.p.h.	Up m.p.h.	
<u>LIVERPOOL STREET TO NORWICH - continued</u>					
Pages 60 and 61 (Page 24, SD PON) - continued:-					
<u>Delete</u> all details between Mellis LC (AHB-X) and Swainsthorpe and <u>substitute</u> - continued:-					
	Palgrave LC (AHB-X)	94 04	<u>X50</u>	<u>X50</u>	<u>Approaching level crossing in wrong direction.</u>
	Diss	94 79			
	Audley End (Norfolk) LC (AHB-X)	97 05	<u>X50</u>	<u>X50</u>	<u>Approaching level crossing in wrong direction.</u>
	Burston LC (AHB-X)	97 42	<u>X50</u>	<u>X50</u>	<u>Approaching level crossing in wrong direction.</u>

SECTION D - GENERAL INSTRUCTIONS AND NOTICES - continued

EASTERN REGION SECTIONAL APPENDIX (SOUTHERN AREA) - continued

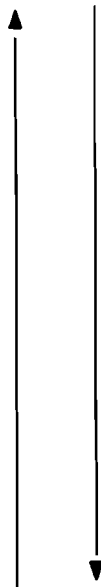
Running Lines and Signalling System	Location	M. Ch.	Permanent Speed Restrictions		Remarks
			Down m.p.h.	Up m.p.h.	
<u>LIVERPOOL STREET TO NORWICH - continued</u>					
Pages 60 and 61 (Page 24, SD PON) - continued:-					
Delete all details between Mellis LC (AHB-X) and Swainsthorpe and substitute - continued:-					
	Gissing LC (AHB-X)	98 57	<u>X50</u>	<u>X50</u>	<u>Approaching level crossing in wrong direction.</u>
	Hales Street LC (AHB-X)	100 27	<u>X50</u>	<u>X50</u>	<u>Approaching level crossing in wrong direction.</u>
	Tivetshall LC (AHB-X)	100 43	<u>X50</u>	<u>X50</u>	<u>Approaching level crossing in wrong direction.</u>
	Moulton LC (AHB-X)	101 51	<u>X50</u>	<u>X50</u>	<u>Approaching level crossing in wrong direction.</u>
	Flordon	106 63			
					Telephones to Colchester signal box at 104m. 41chs. (Signal CO 448R) and at 105m. 19chs. (Signal CO 453R).

SE-54

SECTION D - GENERAL INSTRUCTIONS AND NOTICES - continued

EASTERN REGION SECTIONAL APPENDIX (SOUTHERN AREA) - continued

Running Lines and Signalling System	Location	M. Ch.	Permanent Speed Restrictions		Remarks
			Down m.p.h.	Up m.p.h.	
<u>LIVERPOOL STREET TO NORWICH - continued</u>					
Pages 60 and 61 (Page 24, SD PON) - continued:-					
Delete all details between Mellis LC (AHB-X) and Swainsthorpe and substitute - continued:-					
▲ ●	Newton Flotman LC (AHB-X)	108 19	X50	X50	<u>Approaching level crossing in wrong direction.</u>
▼ ●	Swainsthorpe LC	109 54			(12.SD)
<u>BETHNAL GREEN JN TO KING'S LYNN</u>					
Page 82 (Page 35, SD PON)					
At Reading Lane Jn					
<u>Amend:-</u>					
			10		<u>To Graham Road Curve line.</u> (12.SD)

SECTION D - GENERAL INSTRUCTIONS AND NOTICES - continued

EASTERN REGION SECTIONAL APPENDIX (SOUTHERN AREA) - continued

Running Lines and Signalling System	Location	M. Ch.	Permanent Speed Restrictions		Remarks
			Down m.p.h.	Up m.p.h.	
<u>READING LANE JN TO NAVARINO ROAD JN (GRAHAM ROAD CURVE)</u>					
<u>Page 88</u> (Page 38, SD PON)					
<u>Delete</u> all details and <u>substitute</u> :-					
	Reading Lane Jn (See page 82)	2 55	<u>30</u>	<u>30</u>	MAXIMUM PERMISSIBLE SPEED <u>2m. 55chs. and 2m. 71chs.</u>
	Navarino Road Jn (See page 63)	2 79	<u>10</u>		Controlled by Hackney Downs (H) signal box.
<u>Page 111</u>					Controlled by Dalston Western Jn. (DW) signal box. (12.SD)
<u>TILBURY RIVERSIDE TO PITSEA</u>					
<u>Amend</u> :-	Fobbing LC (AHB)	30 34			(12.SD)

SE-56

SECTION D - GENERAL INSTRUCTIONS AND NOTICES - continuedEASTERN REGION SECTION APPENDIX (SOUTHERN AREA) - continuedINSTRUCTIONS RELATING TO THE RULE BOOKPage 264 (Pages 49 and 50, SD PON)POWER OPERATED POINTS - WRONG DIRECTION MOVEMENTS

<u>Signalbox/location</u>	<u>Point Nos.</u>	
<u>Amend East Gate Jn entry to read :-</u>		
East Gate Jn	25,29	(12.SD)

OTHER GENERAL INSTRUCTIONSPage 297 (Page A37, SD PON)DOCKLANDS LIGHT RAILWAY LINE BETWEEN BOW JN AND STRATFORD STATION
(ADJACENT TO THE B.R. UP ELECTRIC LINE)Amend end of first paragraph to read:-

, except that reference to Electrical Control Operator should be read as Controller and Supervisor at Poplar Control Centre, who can be contacted via the Signaller at Bow Jn or Stratford or the Electrical Control Operator at Romford or on British Telecom 538 3440.

(12.SD)

MISCELLANEOUS NOTICESEXPERIMENTAL ULTRASONIC TEST TRAIN VUR 505

The above train will operate on B.R. for an experimental period and the instructions on Pages 4.15 and 4.16 of the General Appendix apply with the following modifications:-

- 2(d) The air brake test must be carried out by the Guard from the rear driving cab.
5. Whilst on running lines, the following arrangements must be applied in respect of the driving of the train:-

Whilst running from site to site under normal running conditions and during testing, the train will be driven by the Speno Driver who must be accompanied by a Motive Power Conductor.

(30)

SECTION D - GENERAL INSTRUCTIONS AND NOTICES - continuedMISCELLANEOUS NOTICES - continuedWORKING OF CLASS 313 AND CLASS 416 ELECTRIC MULTIPLE UNIT
TRAINS BETWEEN DALSTON WESTERN JN AND STRATFORD MARKETClass 313 Electric Multiple Units

These units must only work between Navarino Road Jn and Stratford Market stabling sidings when either the Graham Road Curve route to Liverpool Street is not available, or when the pantographs have failed to rise. When operating between Dalston Kingsland and Stratford Market stabling sidings and return in the D.C. mode, Drivers must not advance the controller beyond Notch 2.

THESE UNITS MUST NOT RUN BEYOND STRATFORD MARKET TOWARDS NORTH WOOLWICH.

Class 416 Electric Multiple Units

Not more than two Class 416 units may be coupled together.

When two Class 416 units are running in multiple between Dalston Western Jn and Stratford Market, including the stabling sidings or return, Drivers must not advance the controller beyond Notch 2.

(UFN)

BETWEEN STEPNEY EAST AND FENCHURCH STREET

Until further notice, staff of the Docklands Light Railway will be laying in track adjacent to the Up Main/Slow line between Stepney East Station (lm. 58chs.) and Fenchurch Street. Restricted clearances exist and Drivers must keep a sharp look out and be prepared to sound the warning horn as necessary.

(UFN)

BETHNAL GREEN STATION

Until Further Notice, whilst demolition work is taking place, Drivers of 4-Car EMU trains must stop their trains at the temporary stop boards provided.

(UFN)

DALSTON (KINGSLAND) STATION

The Down and Up platforms have been temporarily shortened at the Stratford end by 25 yards and only accommodate two coaches. Drivers of Down trains booked to stop at this station must bring their train to a stand at signal DW14/16. Drivers of Up trains booked to stop at this station must bring their train to a stand at the temporary stop board which has been provided adjacent to the footbridge.

(LM) (UFN)

SECTION D - GENERAL INSTRUCTIONS AND NOTICES - continuedMISCELLANEOUS NOTICES - continuedCAMBRIDGE HEATH STATION

Whilst platform repairs are taking place, Drivers of trains must stop their trains at the temporary stop boards provided.

(UFN)

LONDON FIELDS STATION

The station has reopened but platform repairs are taking place. Whilst this work is being carried out, Drivers must stop their trains at the temporary stop boards provided.

(UFN)

SAWBRIDGEWORTH STATION

The stop board on the Up platform has been temporarily moved 9 yards towards the Country side of its former position.

(UFN)

WANSTEAD PARK STATION

Whilst platform repairs are taking place, Drivers of Up trains must stop their trains at the temporary stop boards provided.

(UFN)

REPAIRS IN MOTIVE POWER DEPOTS, CARRIAGE SHEDS, WAGON REPAIR SHEDS AND WAREHOUSES

In connection with work being carried out at the undermentioned places, scaffolding or projections may be provided or unusual excavations may be made in the ground:-

Location	Nature of Work	Duration	Commencing date
Stratford T.M.D. All lines.	Repairs to Motive Power Depot. Cranes and mechanical equipment in use.	Continuously. Until Further Notice.	-
Ilford EMU Depot, Nos. 19 and 20 Roads.	Drainage.	08 00 to 17 00 daily. Until Further Notice.	-
Ilford EMU Depot, Carriage Washer Roads BLOCKED	Renewal of carriage washer plant. <u>Isolation of electrical sections 361R.</u>	Continuously. Until Further Notice.	-

SECTION D - GENERAL INSTRUCTIONS AND NOTICES - continuedMISCELLANEOUS NOTICES - continuedREPAIRS IN MOTIVE POWER DEPOTS, CARRIAGE SHEDS, WAGON REPAIR SHEDS AND WAREHOUSES - continued

In connection with work being carried out at the undermentioned places, scaffolding or projections may be provided or unusual excavations may be made in the ground:-

Location	Nature of Work	Duration	Commencing date
Ilford EMU Depot, 'B' Shop Roads Nos. 3, 4 and 5.	Construction work. <u>Isolation of electrical sections C3, 4 and 5.</u>	Continuously. Until further notice.	-
Ilford EMU Depot, Nos. 1 and 1A Ley Street Sidings BLOCKED	Construction work. <u>Isolation of electrical sections 361U.</u>	Continuously.	<u>From 09 00 Saturday 11 until 16 00 Sunday 12 October.</u>
Norwich Crown Point T & R.S. M.D., All lines BLOCKED	Construction work (overhead line) and track maintenance. Mechanical equipment in use. <u>Possession to be given up for passage of trains.</u>	08 00 to 17 00 daily. Until further notice.	-
East Ham EMU Depot, All lines.	Shed reconstruction.	Continuously. Until Further Notice.	-
East Ham EMU Depot, Washer Road BLOCKED	Repairs to washer plant. <u>Isolation of electrical sections 509A.</u>	Continuously. Until Further Notice.	-
East Ham EMU Depot, Nos. 10 and 11 Maintenance Shed Roads BLOCKED	Construction work. <u>Isolation of electrical sections EH10, EH11.</u>	Continuously. Until Further Notice.	-

SECTION D - GENERAL INSTRUCTIONS AND NOTICES - continuedMISCELLANEOUS NOTICES - continuedREPAIRS IN MOTIVE POWER DEPOTS, CARRIAGE SHEDS, WAGON REPAIR SHEDS AND WAREHOUSES - continued

In connection with work being carried out at the undermentioned places, scaffolding or projections may be provided or unusual excavations may be made in the ground:-

Location	Nature of Work	Duration	Commencing date
East Ham EMU Depot, Nos. 17, 18, 19 and 20 Sidings BLOCKED to electric trains	In connection with engineering work between East Ham and Barking. Crane and mechanical equipment in use. <u>Isolation of electrical sections 509J.</u>	21 15 Mon to Fri to 05 15 Tue to Sat.	<u>From Monday 6</u> <u>until Saturday</u> <u>11 October.</u>
East Ham EMU Depot, Nos. 17, 18, 19 and 20 Sidings BLOCKED to electric trains	In connection with engineering work between East Ham and Barking. Crane and mechanical equipment in use. <u>Isolation of electrical sections 509J.</u>	21 15 Mon to Fri to 05 15 Tue to Sat.	<u>From Monday 13</u> <u>until Saturday</u> <u>18 October.</u>
Shoeburyness CSD, No. 16 Road BLOCKED	Cleasning Admin. Block windows. <u>Isolation of electrical sections 529A.</u>	10 00 to 12 00. <u>Thursday 16</u> <u>October.</u>	-

MP.32/SE
YORK
2 OCTOBER, 1986

C. McKEEVER
Regional Operations Manager

*

*

*

*

*

*

*

*

*

*

*

*

*

*

*

*

*

*

*

AUTOMATIC OPEN LEVEL CROSSINGS

LOCALLY MONITORED (A.O.C.L.)

Drivers are reminded that they must approach the above level crossings prepared to STOP, UNLESS the Driver's white light is flashing and the crossing is seen to be clear.

If the Driver's white light does not flash, the Driver MUST stop short of the crossing and must not pass over it until he is satisfied it is safe to do so. This is both a requirement of the Department of Transport and Clause 3.3 of the Instruction on Page 7.3 of the General Appendix.

BRITISH RAIL
EASTERN REGION

SE

33

WEEKLY OPERATING NOTICE

CONTAINING

TEMPORARY SPEED RESTRICTIONS

TEMPORARY ENGINEERING WORKS

SIGNALLING AND
PERMANENT WAY ALTERATIONS

GENERAL INSTRUCTIONS AND NOTICES

SATURDAY 8 NOVEMBER

TO

FRIDAY 14 NOVEMBER 1986

INCLUSIVE

Trainmen must pay particular attention to works contained in this notice and keep a good look-out for handsignals which may be exhibited in accordance with the Rules and Regulations.

Work at places other than those mentioned may be in progress and Drivers must be on the look-out and be prepared to stop or run at reduced speed when, and where, handsignals may be exhibited.



WARNING



* *

ENERGISATION OF DOCKLANDS LIGHT RAILWAY BETWEEN
DELTA JUNCTION, STEPNEY EAST, CHRISTIAN STREET
JUNCTION AND TOWER GATEWAY. (ADJACENT TO
B.R. FENCHURCH STREET TO BARKING LINE).

* *

From 00 01 hours on Monday 17 November, 1986, the Conductor
Rails between Delta Junction and Tower Gateway will be energised
at 750 volts D.C. and must thereafter be regarded as 'ALIVE' at
all times.

* *

(12.SD)

* *

SECTION A

TEMPORARY SPEED RESTRICTIONS

(Until further notice unless otherwise specified)

Warning Boards and Indicators provided unless otherwise shown.

† Indicates that the Warning Boards and Indicators will be moved as the work progresses. Where two speeds are shown for a restriction e.g. 20 the Rule Book, Section U, Clause 1.2 applies. 40

 *
 * RULE BOOK : SECTION U *
 *
 * An experimental speed indicator board with black figures on a yellow *
 * background will be used in the Warning Board and Speed Indicator *
 * board for the following Temporary Speed Restriction:- *
 *
 * Church Lane LC Down Up 29 24 29 57 20 Trackwork. *
 * and Chelmsford *
 *
 * In addition to the above equipment an experimental black and white *
 * zebra striped board with twin high powered flashing white lights *
 * will be located at the A.W.S. temporary magnet for the Temporary *
 * Speed Restriction shown above. This board with lights does not *
 * affect the conditions for Drivers working over the Temporary Speed *
 * Restriction, being located only for the purpose of obtaining *
 * reactions to their effectiveness for sighting. *
 *
 * Drivers and Traction Inspectors encountering the experimental *
 * indicators are requested to submit their comments to the Regional *
 * Operations Manager, York under reference MO45/1274 via their *
 * Local Supervisor. *
 *
 *

Location	Lines affected	Mileage		Restr- iction	Remarks
		at or between			
		M. Ch. M. Ch.	m.p.h.		
<u>LIVERPOOL STREET TO NORWICH</u>					
1 Bethnal Green Station Jn and Bow Jn	Down Main	Up Main	1 60 2 10	20	Trackwork. From 11 00 <u>Sunday 9</u> <u>November.</u> (86/33)
2 Bow Jn	Down Main	Up Main	2 60 2 69	40	Bridgework (No. 46). (86/32)

SECTION A - TEMPORARY SPEED RESTRICTIONS - continued

Location	Lines affected		Mileage		Restr- iction m.p.h.	Remarks
			at M.	or between Ch. M. Ch.		
<u>LIVERPOOL STREET TO NORWICH - continued</u>						
3 Bow Jn	Down Electric	-	2 60	2 69	20	Bridgework (No. 46). (86/31)
4 Bow Jn	-	Up Electric	2 69	2 60	20	Bridgework (No. 46). <u>Warning board also provided on Up Main line at 3m. 35chs.</u> (86/31)
5 Harold Wood and Brentwood	Down Main	-	15 02 †	15 75	20	Trackwork. (86/31)
6 Brentwood and and Harold Wood	-	Up Main	15 75 †	15 02	40	Trackwork. (86/31)
7 Brentwood and Ingatestone	Down Main	-	19 65	20 33	50	Condition of track. (86/14)
8 Church Lane LC and Chelmsford	Down	Up	29 24	29 57	20	Trackwork. (86/26)
9 Chelmsford and New Hall G.F.	Down	-	30 50	30 65	50	Condition of track. (86/12)
10 New Hall G.F. and Witham	Down	-	35 65	36 20	30	Trackwork. <u>From 23 00 Saturday 8 until 16 00 Sunday 9 November.</u>
11 Witham and New Hall G.F.	-	Up	36 20	35 65	20	Earthwork. (86/28)
12 Hatfield Peverel and Witham	Down	-	37 20 †	38 00	40	Condition of track. (86/28)
13 Kelvedon	-	Up	42 25	42 10	<u>50</u> 80	Condition of track. (86/7)

SECTION A - TEMPORARY SPEED RESTRICTIONS - continued

Location	Lines affected	Mileage		Restr- iction	m.p.h.	Remarks	
		at or between	M. Ch. M. Ch.				
<u>LIVERPOOL STREET TO NORWICH - continued</u>							
14 Palgrave LC and Rectory Road LC	-	Up		91 40	91 20	20	Earthwork. (86/28)
<u>NAVARINO ROAD JN TO NORTH WOOLWICH</u>							
15 Dalston (Kingsland) and Hackney Central	Up North London/ Down Woolwich	Up Woolwich/ Down North London	(Navarino Road Jn to Camden Road Jn mileage)	1 53	1 23	20	Trackwork. <u>Additional warning board provided on the Reading Lane Jn to Navarino Road Jn (Graham Road Curve) line positioned at signal DW.12.</u> (86/32)
<u>SHENFIELD JN TO SOUTHEND VICTORIA</u>							
16 Billericay and Wickford Station	Down	-		26 10	26 44	40	Condition of track. (86/14)
17 Wick Lane LC and Rayleigh	Down	-		31 35	31 75	40	Condition of embankment. (84/41)
<u>WICKFORD JN TO SOUTHMINSTER</u>							
18 Althorne LC and Burnham-on-Crouch	Single			41 10 †	42 10	20	Trackwork. (85/45)
<u>WITHAM TO BRAINTREE</u>							
19 Cressing and Braintree	Single			18 75	18 68	20	Bridgework (No. 2102B). (86/29)

SECTION A - TEMPORARY SPEED RESTRICTIONS - continued

Location	Lines affected		Mileage		Restr- iction m.p.h.	Remarks
			at M.	between Ch. M. Ch.		
<u>COLCHESTER TO CLACTON</u>						
20 Colchester Road LC and Wivenhoe	-	Up	57 72 †	57 12	40	Condition of track. (86/26)
21 Colchester Road LC	Down	-	58 01	58 04	30	Trackwork. <u>From 23 00</u> <u>Saturday 8</u> <u>until 10 00</u> <u>Wednesday 12</u> <u>November.</u>
22 Colchester Road LC	-	Up	58 04	58 01	30	Trackwork. <u>Until 16 00</u> <u>Sunday 9</u> <u>November.</u> (86/32)
<u>MANNINGTREE SOUTH JN TO HARWICH</u>						
23 Parkeston Goods Jn and Wrabness	-	Up	66 70	66 10	<u>30</u> 50	Condition of track. (86/3)
<u>EAST SUFFOLK JN TO OULTON BROAD NORTH JN</u>						
24 Bealings LC and Westerfield Jn	-	Up	74 60 †	73 44	20	Condition of track. <u>Until 10 00</u> <u>Monday 10</u> <u>November.</u> (86/21)
25 Bealings LC and Westerfield Jn	-	Up	74 60 †	73 44	30	Condition of track. <u>From 10 00</u> <u>Monday 10</u> <u>November.</u> (86/33)
<u>WESTERFIELD JN TO FELIXSTOWE</u>						
26 Trimley	Single		82 55	82 69	20	Trackwork. <u>Until 14 00</u> <u>Monday 10</u> <u>November.</u> (86/28)

SECTION A - TEMPORARY SPEED RESTRICTIONS - continued

Location	Lines affected			Mileage at or between		Restr- iction m.p.h.	Remarks
		M.	Ch.	M.	Ch.		
<u>WESTERFIELD JN TO FELIXSTOWE - continued</u>							
27 Trimley	Single			82 55	82 69	30	Trackwork. <u>From 14 00</u> <u>Monday 10</u> <u>November.</u> (86/33)
<u>NORWICH TO LOWESTOFT</u>							
28 Thorpe Jn and Whitlingham Jn	Down	Up		0 36	0 44	20	Trackwork. (85/20)
29 Whitlingham Jn and Brundall Jn	Down	Up		4 59 †	5 62	20	Trackwork. <u>Until 14 00</u> <u>Monday 10</u> <u>November.</u> (86/28)
30 Whitlingham Jn and Brundall Jn	Down	Up		4 59 †	5 62	30	Trackwork. <u>From 14 00</u> <u>Monday 10</u> <u>November.</u> (86/33)
<u>BETHNAL GREEN JN TO KING'S LYNN</u>							
31 Cambridge Heath	Down Suburban	Up Suburban		1 57	1 67	20	Platform work. (86/24)
32 Angel Road and Brimsdown	Down	Up		9 60	10 02	20	Trackwork. (86/30)
33 Ponders End and Enfield Lock	Down Main	Up Main		10 54	10 70	40	Trackwork. (86/31)
34 Enfield Lock	Down	Up		11 60	11 71	50	Condition of track. (86/31)
35 Sawbridgeworth and Harlow Mill	-	Up		24 76	24 70	60	Condition of track. (86/16)
36 Whittlesford Station	-	Up		49 10	49 00	40	Platform work. (86/29)

SECTION A - TEMPORARY SPEED RESTRICTIONS - continued

Location	Lines affected	Mileage at or between		Restr- iction m.p.h.	Remarks
		M. Ch. M.	Ch. m.p.h.		
<u>COLDHAM LANE JN TO HAUGHLEY JN</u>					
37 Elmswell LC and Haughley Jn	Down	-	37 15 † 38 00	30	Trackwork. <u>Until 10 00</u> <u>Wednesday 12</u> <u>November.</u> (86/27)
<u>ELY NORTH JN TO PETERBOROUGH, CRESCENT JN</u>					
38 Third Drove LC and Welney Road LC	Down	Up	78 00 78 18	20	Condition of track. (86/21)
39 Third Drove LC and Welney Road LC	Down	Up	78 42 78 60	20	Condition of track. (86/21)
40 March East Jn and Badgeney Road LC	-	Up Main	85 36 85 32	10	Condition of track. <u>Warning board</u> <u>positioned at</u> <u>signal ME.45.</u> <u>Additional</u> <u>warning board</u> <u>provided on</u> <u>the March</u> <u>East Jn to</u> <u>Wisbech line,</u> <u>positioned at</u> <u>signal ME.52.</u> (86/31)
41 Three Horse Shoes No. 3 LC	Down	Up	90 74 90 78	<u>20</u> 50	Condition of track. (86/24)

Warning board at 100m. 25chs. (on the Down line) applies only to trains
proceeding over the Down Fast line at Peterborough Station (North).

ELY NORTH JN TO TROWSE LOWER JN

42 Hethersett and Trowse Lower Jn	Down	-	118 60 120 30	60	Signalling work. <u>From 09 00</u> <u>Sunday 9</u> <u>November.</u> (86/33)
--------------------------------------	------	---	---------------	----	--

SECTION A - TEMPORARY SPEED RESTRICTIONS - continued

Location	Lines affected		Mileage		Restr- iction m.p.h.	Remarks
			at M.	or between Ch. M. Ch.		
<u>ELY NORTH JN TO TROWSE LOWER JN - continued</u>						
43 Trowse Lower Jn and Hethersett	-	Up	121 15	119 47	60	Signalling work. <u>From 09 00</u> <u>Sunday 9</u> <u>November.</u> (86/33)
44 Eaton LC and Trowse Lower Jn	Down	Up	121 60	121 64	20	Bridgework (Nos. 1640 and 1640A). (86/23)
<u>FENCHURCH STREET TO SHOEBURYNESS</u>						
45 Gas Factory Jn and Barking Tilbury Line Jn West	Down	Up	4 02	4 38	20	Trackwork. (86/31)
<u>UPPER HOLLOWAY TO BARKING, TILBURY LINE JN WEST</u>						
46 South Tottenham East Jn and Black Horse Road	Down	-	6 45	6 57	20	Condition of track. (85/18)
<u>BARKING, TILBURY LINE JN EAST TO TILBURY RIVERSIDE</u>						
47 Dagenham Dock	Down Main	Up Main	10 47	10 52	20	Level crossing work. <u>Until 14 00</u> <u>Friday 14</u> <u>November.</u> (86/30)
<u>TILBURY RIVERSIDE TO PITSEA</u>						
48 Stanford-le- Hope and Gardners LC	Down	-	30 11	30 60	40	Condition of track. (86/1)
49 Pitsea Hall LC	Down	Up	32 19	32 23	30	Trackwork. <u>From 00 01</u> <u>Sunday 9</u> <u>until 14 00</u> <u>Friday 14</u> <u>November.</u>

SECTION B

TEMPORARY ENGINEERING WORKS

At or between	Lines affected	Remarks
<u>LIVERPOOL STREET TO NORWICH</u>		
UNTIL FURTHER NOTICE		
50	Liverpool Street Station	Platform 1 Demolition work. Mechanical equipment in use. (86/30)
51	Liverpool Street Station	Platforms 1 to 10 Inc. Repairs to station roof. Mechanical equipment in use. (84/41)
52	Liverpool Street Station	Platforms 1 to 18 inc. Cleaning track. (85/21)
53	Liverpool Street Station	Platforms 8, 10 and 11 to 18 inc. Platform work and construction work. Mechanical equipment in use. (86/21)
54	Bethnal Green Station	Down Main and Down and Up Suburban 08 00 to 16 00. Demolition work. (See Section 'D'). (85/41)
55	Bethnal Green and Bow Jn	All Signalling work. (86/25)
56	Stratford and Bow Jn	Up Electric 07 30 to 18 00. Construction work. Mechanical equipment in use. (85/62)
57	Forest Gate Jn and Ilford	All 07 00 to 18 00. Bridgework (No. 75A). 7m. 08chs. Mechanical equipment in use. (85/20)
58	Ilford Station	All 08 00 to 17 00. Repairs to station roof and painting station. (86/2)
59	Romford Jn and Gidea Park	All Bridgework (No. 102B). 12m. 48chs. Crane and mechanical equipment in use. (85/54)

SECTION B - TEMPORARY ENGINEERING WORKS - continued

At or between	Lines affected	Remarks
<u>LIVERPOOL STREET TO NORWICH - continued</u>		
UNTIL FURTHER NOTICE - continued		
60	Ingatestone and Chelmsford	Down and Up 07 30 to 18 00. Construction of bridge (No. 143A). 26m. 51chs. Mechanical equipment in use. (84/35)
61	Chelmsford and Hatfield Peverel	Down and Up 07 30 to 16 00. Earthwork. 35m. 53chs. (85/27)
62	Colchester Jn and Ardleigh LC	Down Main 08 00 to 17 00. Earthwork and formation renewal. 52m. 25chs. and 53m. 75chs. Mechanical equipment in use. (85/41)
63	Manningtree North Jn and Bentley LC	Down and Up <u>Between Trains</u> 07 00 to 18 00. Tree felling, bridgework (No. 229) and earthwork. 60m. 06chs. and 61m. 06chs. Crane and mechanical equipment in use. (85/15)
64	Ipswich Goods Jn and Needham Market	Down Main 08 00 to 16 00. Construction work. 69% and 76m.p. (86/19)
65	East Suffolk Jn and Claydon LC	Down and Up 08 00 to 16 00. Bridgework (No.254A). 70m. 17chs. (85/58)
66	Mellis LC	Down and Up 07 30 to 18 00. Demolition work. 91 $\frac{1}{2}$ mp. Mechanical equipment in use. (86/12)
67	Mellis LC and Trowse Lower Jn	All <u>Between Trains</u> 07 30 to 18 00. Signalling work. Points and signals disconnected. (86/15)
68	Diss and Mellis LC	Up 08 00 to 15 00. Construction work. 94m. 05chs. and 94m.p. (86/17)
69	Diss	Down and Up 07 00 to 19 00. Earthwork. Crane and mechanical equipment in use. (85/27)
70	Diss and Audley End LC	Down and Up Bridgework (No. 315). 95m. 29chs. (86/16)

SECTION B - TEMPORARY ENGINEERING WORKS - continued

<u>At or between</u>	<u>Lines affected</u>	<u>Remarks</u>
<u>LIVERPOOL STREET TO NORWICH - continued</u>		
<u>UNTIL FURTHER NOTICE - continued</u>		
71 Diss and Tivetshall LC	Down and Up	07 30 to 18 00. Demolition work 97m 50chs. Mechanical equipment in use. (86/12)
72 Gissing LC	Down and Up	08 00 to 16 00. Level crossing road repairs. 98m. 56chs. Mechanical equipment in use. (86/26)
73 Hales Street LC	Down and Up	08 00 to 16 00. Level crossing road repairs. 100m. 26chs. Mechanical equipment in use. (86/28)
74 Tivetshall LC	Down and Up	07 30 to 18 00. Demolition work and level crossing road repairs. (Tivetshall LC). 100 $\frac{1}{2}$ m.p. Mechanical equipment in use. (86/28)
75 Tivetshall LC and Swainsthorpe LC	Down and Up <u>Between Trains</u>	07 30 to 18 00. Bridgework (Nos. 328 and 331A) and demolition work. 103m. 13chs. and 104m. 59chs. Crane and mechanical equipment in use. (86/8)
76 Newton Flotman LC	Down and Up	08 00 to 16 00. Level crossing road repairs. 108m. 17chs. Mechanical equipment in use. (86/26)
77 Swainsthorpe LC	Down and Up <u>Between Trains</u>	07 30 to 18 00. Level crossing road repairs and demolition work. 109m. 52chs. and 109 $\frac{3}{4}$ m.p. Mechanical equipment in use. (86/30)
78 Swainsthorpe LC and Trowse Lower Jn.	Down and Up	07 00 to 16 00. Bridgework (No. 346). 110m. 62chs. Mechanical equipment in use. (86/25)

SECTION B - TEMPORARY ENGINEERING WORKS - continued

At or between	Lines affected	Remarks
<u>LIVERPOOL STREET TO NORWICH - continued</u>		
UNTIL FURTHER NOTICE - continued		
79 Trowse Lower Jn and Norwich Station	All <u>Between Trains</u>	07 00 to 17 00. Construction work (overhead line), earthwork, track maintenance and signalling work. Points and signals disconnected. (86/7)
80 Trowse Swing Bridge	Down and Up <u>Between Trains</u>	Bridgework (No. 356). 123m. 36chs. Crane and mechanical equipment in use. (85/33)
81 Trowse Swing Bridge and Thorpe Jn	Down and Up <u>Between Trains</u>	07 30 to 18 00. Construction work. 123 $\frac{1}{2}$ m.p. Crane and mechanical equipment in use. (86/3)
82 Norwich Station	All	Track renewal, platform work and earthwork. Crane and mechanical equipment in use. (85/62)

. FRIDAY/SATURDAY 7/8 NOVEMBER

83 Ilford Car Sheds (London End Jn) and Chadwell Heath Jn	Down and Up Main BLOCKED	23 00 to 05 00. Track maintenance, overhead line work and loading materials. Mechanical equipment in use. <u>Isolation of electrical sections 323B, 324D. Trains to travel over Electric lines.</u>
84 Colchester and Hythe Jn	Down Clacton Avoiding and Clacton Single/ Down and Up Clacton BLOCKED)23 59 to 04 45. Overhead line work.)Mechanical equipment in use.) <u>Isolation of electrical sections 339K, 340N, 381E, 382A. Possession to be given up for passage of Freight trains to/from Hythe. Electric trains to be replatformed as necessary.</u>
Colchester	Platform 5 and Bridge Road BLOCKED to electric trains))))

SECTION B - TEMPORARY ENGINEERING WORKS - continued

At or between	Lines affected	Remarks
LIVERPOOL STREET TO NORWICH - continued		
SATURDAY 8 NOVEMBER		
85 Liverpool Street Station	Platforms 8, 9 and 10 BLOCKED Platform 7 and London End Entry/Exit to/from Locomotive Holding Sidings BLOCKED to electric trains	05 00 to 12 30. Repairs to station roof and construction work. Mechanical equipment in use. <u>Isolation of electrical sections 305CEFGH.</u> <u>Trains to be replatformed as necessary.</u>
86 Bethnal Green and Forest Gate Jn	All	00 30 to 01 45. Signalling work. Points and signals disconnected.
SATURDAY/SUNDAY 8/9 NOVEMBER		
87 Bethnal Green and Bow Jn	Down and Up Main BLOCKED	23 00 to 18 00. Overhead line work, bridgework (Nos. 39 and 46), track maintenance and track renewal. Mechanical equipment in use. <u>Isolation of electrical sections 311B, 312B. Trains to travel over Electric lines.</u>
88 Gidea Park Jn and Shenfield (London End Jn)	Down and Up Main BLOCKED Down and Up Electric	23 00 to 17 00. Reballasting, track maintenance and overhead line work. Mechanical equipment in use. <u>Isolation of electrical sections 331D, 332A. Trains to travel over Electric lines.</u>
89 Shenfield and Witham	All BLOCKED to electric trains	23 50 to 13 30. In connection with engineering work. <u>Isolation of electrical sections 333, 334, 335 and 336.</u>

SECTION B - TEMPORARY ENGINEERING WORKS - continued

At or between	Lines affected	Remarks
<u>LIVERPOOL STREET TO NORWICH - continued</u>		
<u>SATURDAY/SUNDAY 8/9 NOVEMBER - continued</u>		
90 New Hall G.F. and Witham	Up BLOCKED Down BLOCKED	23 15 to 16 00)Track maintenance,)track renewal, 23 50 to 13 30)formation renewal,)loading materials,)drainage and overhead)line work. Crane and)mechanical equipment)in use.) <u>23 50 Sat to 13 30</u>) <u>Possession to be given</u>) <u>up for 1Y02 02 20</u>) <u>Liverpool Street to</u>) <u>Stowmarket over Down</u>) <u>line.</u>) <u>13 30 to 16 00 Sun</u>) <u>Single line working</u>) <u>over Down line.</u>
91 Ipswich Goods Jn and Stowmarket Station (Country End)	Down and Up Main BLOCKED	23 40 to 07 15. Bridgework (Nos. 254 and 257) and track maintenance. 69 $\frac{3}{4}$ m.p. and 72m. 64chs. Mechanical equipment in use. <u>Possession to be given up for passage of 1Y02 02 20 Liverpool Street to Stowmarket over Down Main line.</u>
92 East Suffolk Jn and Haughley Jn	All BLOCKED to electric trains	23 30 to 07 30. In connection with engineering work between Ipswich Goods Jn and Stowmarket Station. <u>Isolation of electrical sections 345 and 346.</u>
93 Haughley Jn and Diss	Up BLOCKED Down BLOCKED	22 00 to 15 30)Track maintenance,)track renewal and 23 35 to 07 15)formation renewal.)Crane and mechanical)equipment in use.) <u>07 15 to 15 30 Sun</u>) <u>Single line working</u>) <u>over Down line.</u>
94 Diss and Flordon	Down and Up BLOCKED	23 55 to 07 00. Loading materials and trimming lineside vegetation. Mechanical equipment in use.

SECTION B - TEMPORARY ENGINEERING WORKS - continued

At or between	Lines affected	Remarks
---------------	----------------	---------

LIVERPOOL STREET TO NORWICH - continued

SATURDAY/SUNDAY 8/9 NOVEMBER - continued

95	Flordon and Trowse Lower Jn	Up BLOCKED Down BLOCKED	22 00 to 06 45) Earthwork. Mechanical equipment in use. 23 55 to 10 00))
96	Trowse Lower Jn and Norwich Station	'C' line/Up Main BLOCKED Down Main/'W' line BLOCKED	23 00 to 06 45) Construction work (overhead line). 23 59 to 07 00) Possession to be given up for passage of 1P04 02 10 Liverpool Street to Yarmouth.
97	Norwich and Whitlingham Jn	'A' and 'E' lines/Down and Up Lowestoft/ Main BLOCKED)23 15 to 07 00. Construction work (overhead line). Possession to be given up for passage of trains.)))
	Norwich Station	Platforms 4, 5 and 6 BLOCKED)))

SATURDAY/SUNDAY 8/9 AND SUNDAY 9 NOVEMBER

98	Liverpool Street and Bethnal Green	Down and Up Suburban BLOCKED	23 15 Sat to 18 00) Repairs to station roof, construction work, demolition work and undertrack
	Liverpool Street Station	Platforms 9 and 10 BLOCKED to electric trains	23 15 Sat to 04 15) excavation. Mechanical equipment in use. Isolation of electrical sections
		Platforms 1 to 8 inc. (and approaches) BLOCKED	23 15 Sat to 18 00) 305 and 306. Trains to travel over Main or Electric lines and to be replatformed
		Locomotive Holding Sidings BLOCKED to electric trains	23 15 Sat to 18 00) as necessary.))))
		Platforms 9 and 10 BLOCKED	04 15 to 18 00 Sun)))

SECTION B - TEMPORARY ENGINEERING WORKS - continued

<u>At or between</u>	<u>Lines affected</u>	<u>Remarks</u>
----------------------	-----------------------	----------------

LIVERPOOL STREET TO NORWICH - continuedSATURDAY/SUNDAY 8/9 AND SUNDAY 9 NOVEMBER - continued

99	Church Lane LC and New Hall G.F.	Up Main BLOCKED Down Main BLOCKED Up Main	23 25 Sat to 13 45 23 45 Sat to 13 50 13 45 to 16 00 Sun)Track maintenance,)track renewal,)repairs to platform)awnings (Chelmsford)Station) and)overhead line work.)Mechanical)equipment in use.) <u>Possession to be given up for passage of 1Y02 02 20 Liverpool Street to Stowmarket over Down Main line.</u>
100	Kelvedon and Marks Tey Station	Up BLOCKED Down BLOCKED	23 30 Sat to 06 15 00 01 to 07 00 Sun)Track maintenance.)Mechanical)equipment in use.) <u>Possession to be given up for passage of 1Y02 02 20 Liverpool Street to Stowmarket over Down line and Engineers' trains.</u>

SUNDAY 9 NOVEMBER

101	Stratford (London End)	Down and Up Main and Down Electric	08 00 to 16 00.	Signalling work (No. 204A points).
102	Gidea Park	Down and Up Electric	08 00 to 16 00.	Signalling work (Nos. 40A points).
103	Shenfield and Church Lane LC	Down and Up Main BLOCKED	00 45 to 07 00.	Track maintenance. <u>Possession to be given up for passage of 1Y02 02 20 Liverpool Street to Stowmarket over Down Main line.</u>

SECTION B - TEMPORARY ENGINEERING WORKS - continued

At or between	Lines affected	Remarks
<u>LIVERPOOL STREET TO NORWICH - continued</u>		
SUNDAY 9 TO FRIDAY 14 NOVEMBER		
104 Trowse Swing Bridge and Norwich	Down Main/ 'W' line and 'C' line/Up Main BLOCKED)23 30 Sun to Thu to 05 00 Mon to)Fri. Construction work (overhead)line) and track maintenance.)Mechanical equipment in use.) <u>Possession to be given up for passage</u>
Norwich Station	Platforms 1, 2 and 3 BLOCKED) <u>of trains.</u>))
105 Norwich and Whitlingham Jn	'A' and 'E' lines/Down and Up Lowestoft/ Main BLOCKED)23 30 Sun to Thu to 05 00 Mon to)Fri. Construction work (overhead)line) and track maintenance.)Mechanical equipment in use.) <u>Possession to be given up for passage</u>
Norwich Station	Platforms 4, 5 and 6 BLOCKED) <u>of trains.</u>))
MONDAY 10 NOVEMBER		
106 Shenfield and Wickford Station	Down and Up Southend and Southend Loop/ Down and Up BLOCKED to electric trains)01 15 to 04 25. In connection with)overhead line work between Shenfield)Jn and Mountnessing Jn. <u>Isolation</u>) <u>of electrical sections 329AB, 330E,)371 and 372.</u>)
Shenfield	Platform 1/Up Passenger Loop BLOCKED to electric trains))))
107 Colchester and Hythe Jn	Down Clacton Avoiding and Clacton Single/ Down and Up Clacton BLOCKED)01 00 to 04 45. Overhead line work.) <u>Isolation of electrical sections)339K, 340N, 381E, 382A. Electric)trains to be replatformed as)necessary.</u>)
Colchester	Platform 5 and Bridge Road BLOCKED to electric trains))))

SECTION B - TEMPORARY ENGINEERING WORKS - continued

At or between	Lines affected	Remarks
<u>LIVERPOOL STREET TO NORWICH - continued</u>		
MONDAY/TUESDAY 10/11 NOVEMBER		
108 Ilford Car Sheds (London End Jn) and Gidea Park Jn	Down and Up Main BLOCKED	23 00 to 05 00. Track maintenance. Mechanical equipment in use. <u>Trains to travel over Electric lines.</u>
MONDAY 10 TO WEDNESDAY 12 NOVEMBER		
109 Liverpool Street Station	Platforms 14 and 15 BLOCKED	23 50 Mon and Tue to 05 00 Tue and Wed. Construction work. Mechanical equipment in use. <u>Isolation of electrical sections 302A, 304D.</u> <u>Trains to be replatformed as necessary.</u>
MONDAY 10 TO FRIDAY 14 NOVEMBER		
110 Liverpool Street Station	Platform 10 BLOCKED	10 40 to 15 40 daily. Construction work. Mechanical equipment in use. <u>Isolation of electrical sections 305H.</u> <u>Trains to be replatformed as necessary.</u>
111 Diss and Haughley Jn	Up BLOCKED	22 00 Mon to Thu to 05 00 Tue to Fri. Track maintenance. Mechanical equipment in use. <u>Possession to be given up for passage of trains.</u>
TUESDAY 11 NOVEMBER		
112 Shenfield (London End) and Mountnessing Jn	Down and Up Electric and Southend Loop (and Middle and Down Sidings) BLOCKED	10 20 to 14 15. Overhead line work. <u>Isolation of electrical sections 329CD, 330CD, 372B.</u> <u>Trains to travel over Main lines.</u> <u>Trains to/from Southend direction to travel over Southend lines.</u>
TUESDAY 11 TO THURSDAY 13 NOVEMBER		
113 Ilford Car Sheds (London End Jn) and Gidea Park Jn	Down and Up Main BLOCKED	23 00 Tue and Wed and 05 00 Wed and Thu. Rail grinding and track maintenance. Mechanical equipment in use. <u>Sparks may be emitted during grinding operations.</u> <u>Trains to travel over Electric lines.</u>

SECTION B - TEMPORARY ENGINEERING WORKS - continued

<u>At or between</u>	<u>Lines affected</u>	<u>Remarks</u>
----------------------	-----------------------	----------------

LIVERPOOL STREET TO NORWICH - continued

TUESDAY 11 TO FRIDAY 14 NOVEMBER

114 Chelmsford and Church Lane LC	Up BLOCKED	00 10 to 05 00 daily. Track maintenance. Mechanical equipment in use. <u>Single line working over Down line.</u>
-----------------------------------	---------------	--

WEDNESDAY 12 TO FRIDAY 14 NOVEMBER

115 Liverpool Street Station	Platforms 14 and 15 BLOCKED	23 50 Wed and Thu to 05 00 Thu and Fri. Construction work. Mechanical equipment in use. <u>Trains to be replatformed as necessary.</u>
------------------------------	--------------------------------	--

THURSDAY/FRIDAY 13/14 NOVEMBER

116 Ilford Car Sheds (London End Jn) and Gidea Park Jn	Down and Up Main BLOCKED	23 00 to 05 00. Track maintenance. Mechanical equipment in use. <u>Trains to travel over Electric lines.</u>
--	-----------------------------	--

FRIDAY 14 TO MONDAY 17 NOVEMBER

117 Bethnal Green and Bow Jn	Down and Up Main BLOCKED	23 00 Fri to 05 00 Mon. Bridgework (No. 36) and overhead line work. Mechanical equipment in use. <u>Isolation of electrical sections 311B, 312B. 23 00 Fri to 12 00 Sat</u> <u>Trains to travel over Electric lines. 12 00 to 23 15 Sat, 02 15 to 04 15 Sun, and 13 30 Sun to 04 00 Mon. Diesel trains to/from Stratford direction to travel over Up Electric (between Bow Jn and Wheler Street Jn)/Up Main (between Wheler Street Jn and Liverpool Street) line under single line working. Trains to/from Hackney Downs direction to travel over Suburban lines between Liverpool Street and Bethnal Green (Country End). 04 00 to 05 00 Mon Trains to travel over Electric lines.</u>
------------------------------	-----------------------------	--

SECTION B - TEMPORARY ENGINEERING WORKS - continued

At or between	Lines affected	Remarks
---------------	----------------	---------

LIVERPOOL STREET TO NORWICH - continued

FRIDAY 14 TO MONDAY 17 NOVEMBER - continued

118	Bethnal Green and Bow Jn	Down Electric	23 00 Fri to 12 00 Sat)	Bridgework (No. 36) and
		Up Electric	23 00 Fri to 04 00 Mon)	overhead line work.
		Down Electric BLOCKED	12 00 Sat to 04 00 Mon)	Mechanical equipment in use. <u>12 00 Sat</u>
	Bethnal Green and Stratford (London End)	Down and Up Electric BLOCKED to electric trains	12 00 Sat to 04 00 Mon)	to 04 00 Mon <u>Isolation of electrical sections 309A, 310B.</u> <u>12 00 to 23 15 Sat, 02 15 to 04 15 Sun, and 13 30 Sun to 04 00 Mon.</u>
				<u>Diesel trains to/from Stratford direction to travel over Up Electric (between Bow Jn and Wheler Street Jn)/Up Main (between Wheler Street Jn and Liverpool Street) line under single line working. Trains to/from Hackney Downs direction to travel over Suburban lines between Liverpool Street and Bethnal Green (Country End).</u>

NAVARINO ROAD JN TO NORTH WOOLWICH

UNTIL FURTHER NOTICE

119	Highbury and Homerton	All	07 30 to 18 00.	Earthwork and construction work. Mechanical equipment in use.
-----	-----------------------	-----	-----------------	---

(86/1)

SUNDAY 9 NOVEMBER

120	Dalston Western Jn and Hackney Central	All BLOCKED to AC electric trains	00 01 to 16 00.	In connection with engineering work between Dalston Western Jn and Channelsea North Jn. <u>Isolation of electrical sections 314DEF.</u>
-----	--	--------------------------------------	-----------------	---

SECTION B - TEMPORARY ENGINEERING WORKS - continued

At or between	Lines affected	Remarks
---------------	----------------	---------

NAVARINO ROAD JN TO NORTH WOOLWICH - continued

SUNDAY 9 NOVEMBER - continued

121	Dalston Western Jn and Channelsea North Jn	All BLOCKED	00 01 to 16 00. Construction work (overhead line), track maintenance and unloading materials. Crane and mechanical equipment in use. <u>Isolation of DC electrical sections 707, 708, 709B, 710A.</u>
122	Channelsea North Jn and Stratford Central Jn West	Down and Up	00 01 to 08 00. Construction work (overhead line). <u>Isolation of electrical sections 705C, 706A.</u>
123	Channelsea South Jn and North Woolwich	All BLOCKED	00 15 to 07 30. Tunnelwork (Stratford Low Level Tunnel) and bridgework (Nos. 618A and 619). <u>Isolation of electrical sections 703, 704, 705AB, 706BC.</u>

STRATFORD, LEA JN TO HIGH MEADS JN

SUNDAY 9 NOVEMBER

124	Lea Jn and High Meads Jn	Down and Up BLOCKED	00 01 to 08 00. Construction work (overhead line). Crane and mechanical equipment in use.
-----	--------------------------	------------------------	---

CHANNELSEA SOUTH JN TO STRATFORD CENTRAL JN WEST

UNTIL FURTHER NOTICE

125	Channelsea South Jn and Stratford Central Jn West	Down and Up BLOCKED to electric trains	In connection with engineering work. (86/14)
-----	---	--	--

SUNDAY 9 NOVEMBER

126	Channelsea North Jn and Stratford Central Jn West	Down and Up	00 01 to 08 00. Construction work (overhead line). <u>Isolation of electrical sections 705C, 706A.</u>
-----	---	-------------	--

SECTION B - TEMPORARY ENGINEERING WORKS - continued

At or between	Lines affected	Remarks
<u>FOREST GATE JN TO WOODGRANGE PARK JN</u>		
SUNDAY 9 NOVEMBER		
127 Forest Gate Jn and Barking Station (Country End)	Down and Up/ Down and Up Tilbury and Up Goods Loop BLOCKED	00 50 to 06 15. Overhead line work and bridgework (No. 14A). Crane and mechanical equipment in use. <u>Isolation of electrical sections 512 and 513. Possession to be given up for passage of Engineers' trains.</u>
<u>ROMFORD TO UPMINSTER</u>		
TUESDAY 11 NOVEMBER		
128 Romford and Upminster	Single BLOCKED	01 00 to 05 00. Overhead line work. <u>Isolation of electrical sections 327D.</u>
<u>SHENFIELD JN TO SOUTHEND VICTORIA</u>		
UNTIL FURTHER NOTICE		
129 Billericay	Down and Up	07 30 to 17 30. Construction work and platform work. Mechanical equipment in use. (86/19)
130 Wickford Station	All	Platform work and earthwork. (85/63)
131 Wickford Jn	All	08 00 to 17 00. Signalling work. (85/41)
132 Rayleigh and Hockley	Down	08 00 to 17 00. Earthwork 34½ and 34¾ m.p. Mechanical equipment in use. (85/61)
133 Southend Victoria Station	All	08 00 to 18 00. Repairs to station roof. (86/20)
SUNDAY 9 NOVEMBER		
134 Wickford Jn and Southend Victoria	Down and Up BLOCKED	00 45 to 07 45. Painting Hockley and Rochford Stations. <u>Possession to be given up for passage of 1K06 03 20 Liverpool Street to Southend Victoria over Down line and 5H43 06 15 Southend Victoria to Thornton Field Car. M.D. over Up line.</u>

SECTION B - TEMPORARY ENGINEERING WORKS - continued

At or between	Lines affected	Remarks
---------------	----------------	---------

SHENFIELD JN TO SOUTHEND VICTORIA - continued

SUNDAY 9 NOVEMBER - continued

135	Rayleigh (London End) and Southend Victoria	Down and Up BLOCKED to electric trains	00 45 to 07 45. In connection with engineering work between Wickford Jn and Southend Victoria. <u>Isolation of electrical sections 375 and 376.</u>
-----	--	--	---

MONDAY 10 NOVEMBER

136	Shenfield and Wickford Station	Down and Up Southend and Southend Loop/ Down and Up BLOCKED to electric trains)01 15 to 04 25. In connection with)overhead line work between Shenfield)Jn and Mountnessing Jn. <u>Isolation)of electrical sections 329AB, 330E,)371 and 372.</u>
	Shenfield	Platform 1/Up Passenger Loop BLOCKED to electric trains))))
137	Shenfield Jn and Mountnessing Jn	Down and Up Southend BLOCKED	01 15 to 04 25. Overhead line work.

TUESDAY 11 NOVEMBER

138	Shenfield (London End) and Mountnessing Jn	Down and Up Electric and Southend Loop (and Middle and Down Sidings) BLOCKED	10 20 to 14 15. Overhead line work. <u>Isolation of electrical sections 329CD, 330CD, 372B. Trains to travel over Main lines. Trains to/from Southend direction to travel over Southend lines.</u>
-----	--	---	--

TUESDAY 11 AND WEDNESDAY 12 NOVEMBER

139	Shenfield Jn and Wickford Station	All BLOCKED to electric trains	00 35 to 04 00 daily. In connection with overhead line work between Mountnessing Jn and Billericay. <u>Isolation of electrical sections 371 and 372.</u>
140	Mountnessing Jn and Billericay (Country End)	Down and Up BLOCKED	00 35 to 04 00 daily. Overhead line work. Mechanical equipment in use.

SECTION B - TEMPORARY ENGINEERING WORKS - continued

At or between	Lines affected	Remarks
---------------	----------------	---------

SHENFIELD JN TO SOUTHEND VICTORIA - continued

TUESDAY 11 AND WEDNESDAY 12 NOVEMBER - continued

141 Wickford Station and Hockley	Down and Up	11 30 to 14 30 daily. Unloading materials. 29½ and 36m.p.
----------------------------------	-------------	---

WICKFORD JN TO SOUTHMINSTER

UNTIL FURTHER NOTICE

142 Wickford Jn	All	08 00 to 17 00. Signalling work. (85/41)
143 Fambridge Station	Single	07 30 to 18 00. Platform work. (85/55)
144 Burnham-on-Crouch	Single	07 30 to 18 00. Earthwork. 43m 24chs. (85/30)

SUNDAY 9 NOVEMBER

145 Wickford Jn and Southminster	Single BLOCKED	00 30 to 08 00. Track maintenance. Mechanical equipment in use.
----------------------------------	-------------------	---

WITHAM TO BRAINTREE

UNTIL FURTHER NOTICE

146 Witham and Braintree	Single	07 00 to 18 00. Construction work (Bridge No. 2102B). (86/19)
--------------------------	--------	---

FRIDAY/SATURDAY 7/8 NOVEMBER

147 Witham and Braintree	Single BLOCKED	23 40 to 05 30. Bridgework (No.2102B), overhead line work and track maintenance. Mechanical equipment in use. <u>Isolation of electrical sections 379.</u>
--------------------------	-------------------	--

SECTION B - TEMPORARY ENGINEERING WORKS - continued

At or between	Lines affected	Remarks
---------------	----------------	---------

WITHAM TO BRAINTREE - continued

SATURDAY/SUNDAY 8/9 NOVEMBER

148	Witham and Braintree	Single BLOCKED	23 40 to 08 45. Bridgework (No.2102B) and overhead line work. Mechanical equipment in use. <u>Isolation of electrical sections 379.</u>
-----	----------------------	-------------------	---

MONDAY 10 TO SATURDAY 15 NOVEMBER

149	Witham and Braintree	Single BLOCKED	23 40 Mon to Fri to 05 30 Tue to Sat. Bridgework (No.2102B) and overhead line work. Mechanical equipment in use. <u>Isolation of electrical sections 379.</u>
-----	----------------------	-------------------	---

COLCHESTER TO CLACTON

UNTIL FURTHER NOTICE

150	Colchester Jn and East Gate Jn	Down Clacton Avoiding	08 00 to 17 00. Earthwork. 52m. 25chs. and 52m. 29chs. Mechanical equipment in use. (85/38)
-----	--------------------------------	-----------------------	--

FRIDAY/SATURDAY 7/8 NOVEMBER

151	Colchester and Hythe Jn	Down Clacton Avoiding and Clacton Single/Down and Up Clacton BLOCKED)23 59 to 04 45. Overhead line work.)Mechanical equipment in use.) <u>Isolation of electrical sections 339K, 340N, 381E 382A. Possession to be given up for passage of Freight trains to/from Hythe Electric trains to be replatformed as necessary.</u>)))
	Colchester	Platform 5 and Bridge Road BLOCKED to electric trains	

SECTION B - TEMPORARY ENGINEERING WORKS - continued

At or between	Lines affected	Remarks
---------------	----------------	---------

COLCHESTER TO CLACTON - continued

SATURDAY/SUNDAY 8/9 NOVEMBER

152	Hythe Station and Great Bentley	Up BLOCKED Down BLOCKED	23 20 to 07 45)Track maintenance)and level crossing 23 20 to 15 45)road repairs) <u>(Colchester Road LC).</u>)Crane and mechanical)equipment in use.) <u>07 15 to 15 45 Sun.</u>) <u>Isolation of electrical</u>) <u>sections 382C, 384A.</u>) <u>07 45 to 15 45 Sun.</u>) <u>Single line working</u>) <u>over Up line.</u>
-----	---------------------------------------	----------------------------------	--

SUNDAY 9 NOVEMBER

153	Colchester Jn and Clacton	All BLOCKED to electric trains	00 10 to 07 15. In connection with engineering work between Hythe Station and Great Bentley. <u>Isolation of</u> <u>electrical sections 381, 382, 383,</u> <u>384, 385 and 386.</u>
-----	------------------------------	--------------------------------------	---

MONDAY 10 NOVEMBER

154	Colchester and Hythe Jn	Down Clacton Avoiding and Clacton Single/ Down and Up Clacton BLOCKED)01 00 to 04 45. Overhead line work.) <u>Isolation of electrical sections</u>) <u>339K, 340N, 381E, 382A. Electric</u>) <u>trains to be replatformed as</u>) <u>necessary.</u>))
	Colchester	Platform 5 and Bridge Road BLOCKED to electric trains))))

EAST GATE JN TO ST BOTOLPHS

SUNDAY 9 NOVEMBER

155	East Gate Jn and St Botolphs	All BLOCKED to electric trains	00 10 to 07 15. In connection with engineering work between Hythe Station and Great Bentley. <u>Isolation of</u> <u>electrical sections 381.</u>
-----	------------------------------------	--------------------------------------	---

SECTION B - TEMPORARY ENGINEERING WORKS - continued

<u>At or between</u>	<u>Lines affected</u>	<u>Remarks</u>
<u>COLNE JN TO HYTHE JN</u>		
SUNDAY 9 NOVEMBER		
156 Colne Jn and Hythe Jn	Down and Up BLOCKED to electric trains	00 10 to 07 15. In connection with engineering work between Hythe Station and Great Bentley. <u>Isolation of electrical sections 381.</u>
<u>THORPE-LE-SOKEN TO WALTON-ON-NAZE</u>		
SUNDAY 9 NOVEMBER		
157 Thorpe-le-Soken and Walton-on-Naze	Single BLOCKED to electric trains	00 10 to 07 15. In connection with engineering work between Hythe Station and Great Bentley. <u>Isolation of electrical sections 387.</u>
<u>MANNINGTREE SOUTH JN TO HARWICH</u>		
UNTIL FURTHER NOTICE		
158 Wrabness and Mistley	Up	07 30 to 17 00. Earthwork. 64m. 46chs. and 64m. 15chs. Mechanical equipment in use. (85/65)
159 Parkeston West and Harwich Town	Single	07 30 to 18 00. Track maintenance, track renewal and earthwork. 70 $\frac{1}{2}$ m.p. Mechanical equipment in use. (85/27)
SATURDAY/SUNDAY 8/9 NOVEMBER		
160 Parkeston Goods Jn and Parkeston East LC	All BLOCKED	23 20 to 06 45. Track maintenance. Mechanical equipment in use.
MONDAY 10 TO WEDNESDAY 12 NOVEMBER		
161 Wrabness and Parkeston Goods Jn	Down BLOCKED	23 15 Mon and Tue to 05 00 Tue and Wed. Track maintenance. Mechanical equipment in use. <u>Single line working over Up line.</u>

SECTION B - TEMPORARY ENGINEERING WORKS - continued

At or between	Lines affected	Remarks
---------------	----------------	---------

MANNINGTREE SOUTH JN TO HARWICH - continued

WEDNESDAY/THURSDAY 12/13 NOVEMBER

162 Harwich , Parkeston Quay and Harwich Town	Single BLOCKED	23 35 to 05 20. Track maintenance. Mechanical equipment in use. <u>Possession to be given up for passage of Freight trains.</u>
--	-------------------	---

EAST SUFFOLK JN TO OULTON BROAD NORTH JN

UNTIL FURTHER NOTICE

163 Westerfield Jn and Woodbridge	Down and Up BLOCKED	07 00 to 19 00. Bridgework (No.418A). 76m. 65chs. Mechanical equipment in use. <u>Possession to be given up for passage of trains.</u> <u>From 07 00 Sunday 9 November</u> (86/33)
--------------------------------------	------------------------	--

SATURDAY/SUNDAY 8/9 NOVEMBER

164 Woodbridge , and Saxmundham	All BLOCKED	23 10 to 09 45. Track maintenance. Mechanical equipment in use.
165 Halesworth , and Oulton Broad North Jn	Single BLOCKED	22 30 to 08 00. Track maintenance. 116 $\frac{1}{2}$ m.p. and 116m. 25chs. Mechanical equipment in use.

SATURDAY 8 TO MONDAY 10 NOVEMBER

166 Westerfield and Woodbridge	Down BLOCKED Up BLOCKED	23 10 Sat to 10 30 Sun)Track)Maintenance, 23 10 Sat to 05 00 Mon)track renewal)and loading)materials.)Crane and)mechanical)equipment in)use. <u>10 30 Sun</u>) <u>to 05 00 Mon.</u>) <u>Single line</u>) <u>working over</u>) <u>Down line.</u>
-----------------------------------	----------------------------------	--

SECTION B - TEMPORARY ENGINEERING WORKS - continued

At or between	Lines affected	Remarks
---------------	----------------	---------

EAST SUFFOLK JN TO OULTON BROAD NORTH JN - continued

MONDAY 10 TO WEDNESDAY 12 NOVEMBER

167	Westerfield Jn and Woodbridge	Down and Up BLOCKED	23 15 Mon and Tue to 06 15 Tue and Wed. Bridgework (Nos 412, 420 and 424) and track maintenance. Mechanical equipment in use.
-----	-------------------------------	------------------------	---

MONDAY 10 TO FRIDAY 14 NOVEMBER

168	Woodbridge and Saxmundham	All BLOCKED	23 00 Mon to Thu to 05 30 Tue to Fri. Track maintenance and loading rails and materials. Crane and mechanical equipment in use.
169	Halesworth and Oulton Board South	Single BLOCKED	08 00 to 16 00 daily. Trimming lineside vegetation and trolleying materials. Mechanical equipment in use. <u>Possession to be given up for passage of trains.</u>

WEDNESDAY/THURSDAY 12/13 NOVEMBER

170	East Suffolk Jn and Westerfield	Down BLOCKED	22 00 to 05 45. Bridgework (No. 404). 69m. 70chs. and 70m. 10chs. Mechanical equipment in use. <u>Single line working over Up line.</u>
-----	---------------------------------	-----------------	---

THURSDAY/FRIDAY 13/14 NOVEMBER

171	Woodbridge and Westerfield Jn	Up BLOCKED	23 15 to 06 15. Track maintenance. Mechanical equipment in use.
-----	-------------------------------	---------------	---

WESTERFIELD JN TO FELIXSTOWE

UNTIL FURTHER NOTICE

172	Westerfield Jn and Derby Road	Single	08 00 to 16 00. Earthwork. 73m. 13chs. and 73 $\frac{1}{2}$ m.p. (85/61)
173	Derby Road and Felixstowe Beach Jn	Single	07 30 to 17 00. Earthwork. 82 $\frac{1}{2}$ and 83m.p. Mechanical equipment in use. (86/1)

SECTION B - TEMPORARY ENGINEERING WORKS - continued

At or between	Lines affected	Remarks
---------------	----------------	---------

WESTERFIELD JN TO FELIXSTOWE - continued

SATURDAY 8 TO MONDAY 10 NOVEMBER

174	Derby Road and Felixstowe Beach Jn	Single BLOCKED	22 00 Sat to 05 00 Mon. Level crossing road repairs (Trimley LC). Crane and mechanical equipment in use.
-----	------------------------------------	----------------	--

NORWICH TO LOWESTOFT

UNTIL FURTHER NOTICE

175	Norwich Station	All	Track renewal, platform work and earthwork. Crane and mechanical equipment in use. (85/62)
176	Norwich Station and Trowse Lower Jn	All <u>Between Trains</u>	07 00 to 17 00. Construction work (overhead line), earthwork, track maintenance and signalling work. Points and signals disconnected. (86/7)
177	Thorpe Jn	All	08 00 to 17 00. Earthwork and track maintenance. (85/22)
178	Whitlingham Jn and Thorpe Jn	Up	07 30 to 17 00. Earthwork 1½ and 1m.p. Mechanical equipment in use. (86/13)
179	Reedham Swing Bridge	Down and Up BLOCKED	08 00 to 16 00. Bridgework (No. 1238). <u>Possession to be given up for passage of trains.</u> (86/23)
180	Oulton Broad North Jn and Lowestoft	All	08 00 to 16 00. Undertrack excavation. 23 and 23½m.p. (86/26)

SATURDAY/SUNDAY 8/9 NOVEMBER

181	Trowse Lower Jn and Norwich Station	'C' line/Up Main BLOCKED Down Main/'W' line BLOCKED	23 00 to 06 45) Construction work (overhead line). 23 59 to 07 00) <u>Possession to be given up for passage of 1P04 02 10 Liverpool Street to Yarmouth.</u>
-----	-------------------------------------	--	--

SECTION B - TEMPORARY ENGINEERING WORKS - continued

At or between	Lines affected	Remarks
<u>NORWICH TO LOWESTOFT - continued</u>		
<u>SATURDAY/SUNDAY 8/9 NOVEMBER - continued</u>		
182 Norwich and Whitlingham Jn	'A' and 'E' lines/ Down and Up Lowestoft/Main BLOCKED)23 15 to 07 00. Construction work) <u>(overhead line). Possession to be</u>) <u>given up for passage of trains.</u>)))
Norwich Station	Platforms 4, 5 and 6 BLOCKED)))
183 Whitlingham Jn and Cantley	Down BLOCKED Up BLOCKED	23 30 to 08 00)Track maintenance,)loading rails and 23 30 to 16 00)level crossing road)repairs (Brundall LC).)Crane and mechanical)equipment in use.)23 30 Sat to 08 00) <u>Possession to be given</u>) <u>up for passage of 1P04</u>) <u>02 10 Liverpool Street</u>) <u>to Yarmouth and 1B02</u>) <u>04 39 Norwich to</u>) <u>Lowestoft over Down</u>) <u>line. 08 00 to 16 00</u>) <u>Sun Single line working</u>) <u>over Down line.</u>
184 Oulton Broad North and Lowestoft	Up BLOCKED Down BLOCKED	23 00 to 07 30)Track maintenance. 22m.)10chs. and 22½m.p. 23 59 to 07 30)Mechanical equipment in)use. <u>Possession to be</u>) <u>given up for passage of</u>) <u>trains.</u>

SUNDAY 9 TO FRIDAY 14 NOVEMBER

185 Trowse Swing Bridge and Norwich	Down Main/ 'W' line and 'C' line/Up Main BLOCKED)23 30 Sun to Thu to 05 00 Mon to)Fri. Construction work (Overhead)line) and track maintenance.)Mechanical equipment in use.) <u>Possession to be given up for</u>) <u>passage of trains.</u>))
Norwich Station	Platforms 1, 2, and 3 BLOCKED)))

SECTION B - TEMPORARY ENGINEERING WORKS - continued

At or between	Lines affected	Remarks
---------------	----------------	---------

NORWICH TO LOWESTOFT - continued

SUNDAY 9 TO FRIDAY 14 NOVEMBER - continued

186	Norwich and Whitlingham Jn	'A' and 'E' lines/Down and Up Lowestoft/ Main BLOCKED)23 30 Sun to Thu to 05 00 Mon to Fri.)Construction work (overhead line) and)track maintenance. Mechanical)equipment in use. <u>Possession to be given up for passage of trains.</u>))))
	Norwich Station	Platforms 4, 5 and 6 BLOCKED))))

WHITLINGHAM JN TO CROMER

UNTIL FURTHER NOTICE

187	Whitlingham Jn and Wroxham	Down and Up	07 30 to 16 30. Bridgework (No. 365). 3m. 48chs. (86/6)
188	Cromer Station	Platforms 1 and 2	Platform work. (86/15)

CROMER TO SHERINGHAM

* UNTIL FURTHER NOTICE

189	Cromer Station	Platforms 1 and 2	Platform work. (86/15)
-----	----------------	----------------------	-------------------------------

BRUNDALL JN TO YARMOUTH VIA ACLE

UNTIL FURTHER NOTICE

190	Lingwood	Single	08 00 to 17 00. Construction work. 8m. 03chs. (86/12)
191	Brundall Jn and Yarmouth	All	08 00 to 16 00. Signalling work. (86/30)

SUNDAY 9 NOVEMBER

192	Brundall Jn and Yarmouth	Single BLOCKED	07 00 to 16 00. Trolleying materials. 6 and 18m.p.
-----	-----------------------------	-------------------	---

SECTION B - TEMPORARY ENGINEERING WORKS - continued

At or between	Lines affected	Remarks
<u>REEDHAM JN TO YARMOUTH</u>		
UNTIL FURTHER NOTICE		
193 Reedham Jn and Yarmouth	All	08 00 to 16 00. Signalling work. (86/30)
<u>BETHNAL GREEN JN TO KING'S LYNN</u>		
UNTIL FURTHER NOTICE		
194 Cambridge Heath Station	Down and Up Suburban	08 00 to 17 00. Platform work. 1m. 61chs. Mechanical equipment in use. (<u>See Section 'D'</u>). (86/24)
195 London Fields Station	Down and Up Suburban	Platform work. 2m. 35chs. Mechanical equipment in use. (<u>See Section 'D'</u>). (86/27)
196 Enfield Lock Station	Up	08 00 to 16 30. Platform work. 11m. 65chs. Mechanical equipment in use. (86/28)
197 Enfield Lock and Waltham Cross	Down and Up	07 00 to 18 00. Bridgework (No.1418C). 12m. 34chs. Crane and mechanical equipment in use. (85/59)
198 Bishops Stortford (Country end) and Stansted	Down and Up Main BLOCKED to electric trains	Overhead line work. <u>Isolation of electrical sections 427, 428 (buffer section).</u> (85/41)
199 Bishops Stortford and Cambridge (North)	All	07 00 to 18 00. Construction work (overhead line). Mechanical equipment in use. (85/21)
200 Stansted and Chesterton Jn	All	08 00 to 18 00. Signalling work. <u>From 08 00 Monday 10 November.</u> (86/33)
201 Whittlesford Station	Down and Up	Platform work. 49m. 02chs. Mechanical equipment in use. (86/29)
202 Chesterton Jn and Milton Fen LC	Down and Up	07 30 to 18 00. Bridgework (No. 1550B). 58m. 63chs. Mechanical equipment in use. (86/24)

SECTION B - TEMPORARY ENGINEERING WORKS - continued

<u>At or between</u>	<u>Lines affected</u>	<u>Remarks</u>
<u>BETHNAL GREEN JN TO KING'S LYNN - continued</u>		
SATURDAY 8 NOVEMBER		
203 Coldham Lane Jn and Waterbeach	All <u>Between Trains</u>	07 00 to 16 00. Bridgework (Nos.1547, 1548, 1548A, 1549 and 1550A).
SATURDAY/SUNDAY 8/9 NOVEMBER		
204 Bishops Stortford (London End) and Stansted	Platform 1/ Down Main and Up Main BLOCKED to electric trains	18 00 to 10 00. In connection with engineering work between Bishops Stortford and Elsenham. <u>Isolation of electrical sections 417AB, 418C.</u>
205 Bishops Stortford and Elsenham	Up Main BLOCKED Down Main BLOCKED	22 30 to 08 30)Construction work.) (overhead line). 23 40 to 09 00)30% and 35% <u>m.p.</u>)Mechanical equipment in)use. <u>Possession to</u>) <u>be given up for passage</u>) <u>of 1P04 02 10 Liverpool</u>) <u>Street to Yarmouth and</u>) <u>1H02 03 10 Liverpool</u>) <u>Street to King's Lynn</u>) <u>over Down Main line.</u>
206 Audley End and Great Chesterford	Down and Up BLOCKED	23 50 to 08 00. Tunnelwork (Audley End and Littlebury tunnels) and trimming lineside vegetation. 42 and 43% <u>m.p.</u> Mechanical equipment in use. <u>Possession to be given up for passage</u> <u>of 1P04 02 10 Liverpool Street to</u> <u>Yarmouth and 1H02 03 10 Liverpool</u> <u>Street to King's Lynn over Down line.</u>
SUNDAY 9 NOVEMBER		
207 Hackney Downs North Jn and and Copper Mill North Jn/ Chingford	All BLOCKED	00 55 to 06 25. Track maintenance 3m. 79chs. and 4m. 21chs. <u>Trains diverted</u> <u>via Southbury.</u>

SECTION B - TEMPORARY ENGINEERING WORKS - continued

<u>At or between</u>	<u>Lines affected</u>	<u>Remarks</u>
----------------------	-----------------------	----------------

BETHNAL GREEN JN TO KING'S LYNN - continued

SUNDAY 9 NOVEMBER - continued

208	Clapton Jn and Cheshunt Jn	Down and Up Main BLOCKED to electric trains	00 01 to 22 00. In connection with engineering work between Tottenham South Jn and Cheshunt Jn. <u>Isolation of electrical sections 411 and 412. Electric trains diverted via Southbury.</u>
209	Tottenham South Jn and Cheshunt Jn	Down and Up Main BLOCKED	00 01 to 22 00. Track maintenance, formation renewal, drainage and overhead line work. Crane and mechanical equipment in use. <u>Trains diverted via Southbury.</u>
210	Audley End	Up Main	08 00 to 12 00. Signalling work. <u>(See Section 'C').</u>
211	Whittlesford Station and Shelford LC	All	08 00 to 18 00. Signalling work.
212	Shepreth Branch Jn and Coldham Lane Jn	All <u>Between Trains</u>	00 30 to 08 00. Construction work. (overhead line). 53% and 56% m.p. Mechanical equipment in use.
213	Cambridge Station	Platforms 2 and 3 BLOCKED	01 30 to 08 00. Track maintenance. 55% and 55% m.p. <u>Trains to be replatformed as necessary.</u>
214	Waterbeach and Ely Dock Jn	Down and Up BLOCKED	00 35 to 08 00. Track maintenance. 61 and 69 m.p. <u>Possession to be given up for passage of 1P04 02 10 Liverpool Street to Yarmouth and 1H02 03 10 Liverpool Street to King's Lynn over Down line.</u>
215	Littleport Bypass LC	Down and Up	07 00 to 16 00. Signalling work.

SUNDAY/MONDAY 9/10 NOVEMBER

216	Shepreth Branch Jn and Cambridge	Down Main and Down Goods Loop South BLOCKED	23 00 to 05 30. Construction work (overhead line). 53% and 56 m.p. Mechanical equipment in use. <u>Single line working over Up Main line.</u>
-----	----------------------------------	--	---

SECTION B - TEMPORARY ENGINEERING WORKS - continued

<u>At or between</u>	<u>Lines affected</u>	<u>Remarks</u>
<u>BETHNAL GREEN JN TO KING'S LYNN - continued</u>		
MONDAY 10 NOVEMBER		
217 Clapton Jn and Broxbourne Jn (County End)	All BLOCKED to electric trains	01 00 to 03 55. In connection with overhead line work between Brimsdown and Cheshunt Station. <u>Isolation of electrical sections 411, 412, 413 and 414.</u>
218 Brimsdown and Cheshunt Station	Down and Up Main BLOCKED	01 00 to 03 55. Overhead line work. <u>Possession to be given up for passage of Diesel trains.</u>
MONDAY/TUESDAY 10/11 NOVEMBER		
219 Harlow Town and Broxbourne Jn	Up BLOCKED	23 05 to 04 40. Track maintenance. Mechanical equipment in use. <u>Single line working over Down line.</u>
MONDAY 10 AND TUESDAY 11 NOVEMBER		
220 Elsenham and Stansted	Up BLOCKED	09 20 to 15 45 daily. Construction work (overhead line). 35½ and 33¾m.p. <u>Single line working over Down line.</u>
MONDAY 10 TO FRIDAY 14 NOVEMBER		
221 Shepreth Branch Jn and Coldham Lane Jn	All <u>Between Trains</u>	08 00 to 16 00 daily. Construction work (overhead line). 53¾ and 56¾m.p. Mechanical equipment in use.
222 Shepreth Branch Jn and Coldham Lane Jn	All <u>Between Trains</u>	23 30 Mon to Thu to 06 30 Tue to Fri. Construction work (overhead line). 53¾ and 56¾m.p. Mechanical equipment in use.
WEDNESDAY 12 AND THURSDAY 13 NOVEMBER		
223 Tottenham Hale and Brimsdown	Down BLOCKED	00 01 to 05 45 daily. Track maintenance. Mechanical equipment in use. <u>Single line working over Up line.</u>

SECTION B - TEMPORARY ENGINEERING WORKS - continued

At or between	Lines affected	Remarks
<u>BETHNAL GREEN JN TO KING'S LYNN - continued</u>		
WEDNESDAY 12 TO FRIDAY 14 NOVEMBER		
224 Stansted and Bishops Stortford	Up Main BLOCKED	09 30 to 15 50 daily. Construction work (overhead line). 33% and 30% m.p. , <u>Single line working over Down Main line.</u>

THURSDAY/FRIDAY 13/14 NOVEMBER

225 Harlow Mill and Spelbrook	Down BLOCKED	23 15 to 04 40. Rail grinding and track maintenance. Mechanical equipment in use. <u>Sparks may be emitted during grinding operations.</u> <u>Single line working over Up line.</u>
-------------------------------	-----------------	--

READING LANE JN TO NAVARINO ROAD JN (GRAHAM ROAD CURVE)

SUNDAY 9 NOVEMBER

226 Reading Lane Jn and Navarino Road Jn	Single BLOCKED to electric trains	00 01 to 16 00. In connection with engineering work between Dalston Western Jn and Channelsea North Jn. <u>Isolation of electrical sections 314C.</u>
--	---	--

CLAPTON JN TO CHINGFORD

SATURDAY 8 NOVEMBER

227 Clapton Jn and Chingford	Down and Up BLOCKED	00 55 to 04 00. Overhead line work. Mechanical equipment in use. <u>Isolation of electrical sections 409 and 410.</u>
------------------------------	------------------------	--

SUNDAY 9 NOVEMBER

228 Hackney Downs North Jn and Copper Mill North Jn/ Chingford	All BLOCKED	00 55 to 06 25. Track maintenance. 3m. 79chs. and 4m. 21chs. <u>Trains diverted via Southbury.</u>
--	----------------	--

THURSDAY 13 AND FRIDAY 14 NOVEMBER

229 Clapton Jn and Chingford	Down and Up BLOCKED	00 25 to 04 00 daily. Overhead line work. Mechanical equipment in use. <u>Isolation of electrical sections 409 and 410.</u>
------------------------------	------------------------	--

SECTION B - TEMPORARY ENGINEERING WORKS - continued

At or between	Lines affected	Remarks
---------------	----------------	---------

BROXBOURNE JN TO HERTFORD EAST

UNTIL FURTHER NOTICE

230 Rye House and St. Margarets	Down and Up	08 00 to 18 00. Bridgework (No. 2035A). 19m. 66chs. Mechanical equipment in use. (85/60)
---------------------------------	-------------	---

SUNDAY 9 NOVEMBER

231 Broxbourne Jn and Hertford East	All BLOCKED	00 30 to 06 30. Platform work and construction work (St. Margarets Station). Mechanical equipment in use. <u>Isolation of electrical sections 434 and 435.</u>
-------------------------------------	-------------	--

MONDAY 10 NOVEMBER

232 Broxbourne Jn and St. Margarets	Down and Up BLOCKED to electric trains	01 00 to 03 55. In connection with overhead line work between Brimsdown and Cheshunt Station. <u>Isolation of electrical sections 414.</u>
-------------------------------------	--	--

TUESDAY 11 TO FRIDAY 14 NOVEMBER

* 233 Broxbourne Jn and Hertford East	All BLOCKED	00 35 to 04 50 daily. Platform work and construction work (St. Margarets Station). Mechanical equipment in use.
---------------------------------------	-------------	---

COLDHAM LANE JN TO HAUGHLEY JN

UNTIL FURTHER NOTICE

234 Bury St. Edmunds Station	Down	08 00 to 15 00. Repairs to platform awnings. (86/18)
235 Bury St. Edmunds and Elmswell	Down and Up	08 00 to 18 00. Drainage. 29m. 78chs. Mechanical equipment in use. (86/12)

SECTION B - TEMPORARY ENGINEERING WORKS - continued

At or between	Lines affected	Remarks
---------------	----------------	---------

COLDHAM LANE JN TO HAUGHLEY JN - continued

SATURDAY/SUNDAY 8/9 NOVEMBER

236 Kennett and Bury St. Edmunds	Down and Up BLOCKED	23 00 to 13 30. Track maintenance and loading rails. Crane and mechanical equipment in use.
----------------------------------	------------------------	---

SUNDAY 9 NOVEMBER

237 Bury St. Edmunds and Haughley Jn	Down and Up	07 00 to 13 15. Loading rails. Mechanical equipment in use.
--------------------------------------	-------------	---

ELY NORTH JN TO PETERBOROUGH, CRESCENT JN

SATURDAY 8 TO SUNDAY 9 NOVEMBER

238 Chettisham and Manea	Down BLOCKED Up BLOCKED	11 30 Sat to 18 00 Sun) Bridgework (Nos. 1813 and 11 45 Sat to 14 00 Sun) 1814) 78 and) 78 ³ m.p. Crane) and mechanical) equipment in) use. <u>14 00</u>) to <u>18 00 Sun.</u>) <u>Single line</u>) <u>working over</u>) <u>Up line.</u>
--------------------------	----------------------------------	---

SUNDAY 9 NOVEMBER

239 Black Bank and Manea	Down and Up	07 00 to 14 00. Signalling work.
240 March West Jn. and Whittlesea	Down and Up Main BLOCKED	00 01 to 08 00. Loading materials. 92 and 94m.p. Mechanical equipment in use.

WEDNESDAY/THURSDAY 12/13 NOVEMBER

241 Chettisham and Manea	Down BLOCKED	23 15 to 05 00. Bridgework (Nos. 1813 and 1814). 78 and 78 ³ m.p. <u>Single line working over Up line.</u>
--------------------------	-----------------	---

SECTION B - TEMPORARY ENGINEERING WORKS - continued

At or between	Lines affected	Remarks
<u>ELY NORTH JN TO TROWSE LOWER JN</u>		
UNTIL FURTHER NOTICE		
242	Thetford and Lakenheath	Up 08 00 to 16 00. Track maintenance. 87% and 85% m.p. (86/24)
243	Wymondham and Hethersett	Down and Up <u>Between Trains</u> 07 30 to 18 00. Bridgework, earthwork and construction work. 115m. 65chs. and 117m. 69chs. Cranes and mechanical equipment in use. (86/18)
244	Wymondham and Trowse Lower Jn	Down and Up 07 30 to 16 00. Signalling work. (85/24)
245	Hethersett and Trowse Lower Jn	Down and Up 07 30 to 16 00. Bridgework (Nos. 1638, 1640, 1640A and 349). 121m. 17chs. and 122m. 32chs. (86/22)

SATURDAY 8 TO SUNDAY 9 NOVEMBER

246	Hethersett and Trowse Lower Jn	Down and Up 07 00 Sat to 22 00 Sun. Signalling work. <u>(See Section 'C')</u> .
-----	--------------------------------	--

SATURDAY/SUNDAY 8/9 NOVEMBER

247	Hethersett and Trowse Lower Jn	Up BLOCKED Down BLOCKED
		21 30 to 16 30) Bridgework (Nos. 1640 and 1640A). 121% m.p. 23 35 to 07 15) Crane and mechanical equipment in use.) 23 35 Sat to 07 15.) Possession to be given up for passage of 1P04) 02 10 Liverpool Street) to Yarmouth over Down) line. 07 15 to 16 30) Sun. Single line) <u>working over Down line.</u>

SECTION B - TEMPORARY ENGINEERING WORKS - continued

<u>At or between</u>	<u>Lines affected</u>	<u>Remarks</u>
<u>ELY NORTH JN TO TROWSE LOWER JN - continued</u>		
MONDAY 10 TO WEDNESDAY 12 NOVEMBER		
248 Lakenheath and Brandon	Down BLOCKED	22 45 Mon and Tue to 05 45 Tue and Wed. Loading rails. Mechanical equipment in use.
MONDAY 10 TO FRIDAY 14 NOVEMBER		
249 Brandon and Harling Road	Down and Up BLOCKED	23 30 Mon to Thu to 06 15 Tue to Fri. Trimming lineside vegetation and track maintenance. Mechanical equipment in use.
WEDNESDAY 12 TO FRIDAY 14 NOVEMBER		
250 Attleborough and Wymondham	Down and Up BLOCKED	23 15 Wed and Thu to 06 30 Thu and Fri. Loading rails. Mechanical equipment in use.
<u>WYMONDHAM TO NORTH ELMHAM</u>		
UNTIL FURTHER NOTICE		
251 Wymondham and North Elmham	Single	08 00 to 16 00. Trimming lineside vegetation. ½ and 6m.p. Mechanical equipment in use. (85/31)
MONDAY 10 TO FRIDAY 14 NOVEMBER		
252 Wymondham and North Elmham	Single	08 00 to 16 00 daily. Trimming lineside vegetation. 7½ and 9½m.p. Mechanical equipment in use.
<u>FENCHURCH STREET TO SHOEBURYNESSE</u>		
UNTIL FURTHER NOTICE		
253 Fenchurch Street Station	All	Construction/demolition work. Mechanical equipment in use. (84/38)

SECTION B - TEMPORARY ENGINEERING WORKS - continued

At or between	Lines affected	Remarks
---------------	----------------	---------

FENCHURCH STREET TO SHOEBURYNESS - continued

UNTIL FURTHER NOTICE - continued

254	Fenchurch Street and Stepney East	All	Construction work, and in connection with engineering work (Docklands Light Railway). Mechanical equipment in use. <u>(See Section 'D')</u> . (86/25)
255	Fenchurch Street and Gas Factory Jn	All	08 00 to 17 00. Signalling work. (86/1)
256	East Ham	Down and Up	Construction work. Mechanical equipment in use. (83/51)
257	East Ham and Barking (London End)	Down and Up	Erecting scaffolding in connection with bridge No. 66B. (85/8)
258	Leigh-on-Sea and Benfleet	Up	Sea wall work. (85/34)
259	Leigh-on-Sea	Down	09 00 to 16 00. Demolition work. Mechanical equipment in use. (85/60)
260	Westcliff-on-Sea	Down	09 00 to 16 00. Demolition work. Mechanical equipment in use. (85/60)

FRIDAY/SATURDAY 7/8 NOVEMBER

261	Fenchurch Street and Gas Factory Jn	All BLOCKED	21 15 to 06 00. Repairs to platform awnings (Stepney East Station), construction work and painting Stepney East Station. <u>Isolation of electrical sections 501, 502, 503 and 504.</u>
262	Gas Factory Jn and East Ham (London End)	Down and Up BLOCKED	21 15 to 06 00. Track maintenance, unloading materials and undertrack excavation. Mechanical equipment in use. <u>Isolation of electrical sections 507 and 508.</u>

SECTION B - TEMPORARY ENGINEERING WORKS - continued

At or between	Lines affected	Remarks
---------------	----------------	---------

FENCHURCH STREET TO SHOEBURYNESSE - continued

FRIDAY 7 TO MONDAY 10 NOVEMBER

263	Fenchurch Street Station	Platforms 1 and 2 BLOCKED	21 15 Fri to 06 00 Sat)	Construction work
		Platforms 3 and 4 BLOCKED	21 15 Fri to 05 00 Mon)	(installing escalator). Mechanical equipment in use. <u>Isolation of electrical sections 501D, 502A.</u> <u>Trains to be replatformed as necessary.</u>

SATURDAY 8 NOVEMBER

264	Upminster and Pitsea	Down and Up BLOCKED	01 15 to 04 25.	Overhead line work. Crane and mechanical equipment in use. <u>Isolation of electrical sections 517, 518, 519 and 520.</u> <u>Trains diverted via Grays.</u>
-----	----------------------	------------------------	-----------------	--

SATURDAY/SUNDAY 8/9 NOVEMBER

265	Gas Factory Jn and East Ham (London End)	Down and Up BLOCKED	21 15 to 18 00.	Track maintenance. Crane and mechanical equipment in use. <u>Isolation of electrical sections 507 and 508. Trains diverted via Stratford and Forest Gate Jn.</u>
-----	--	------------------------	-----------------	--

SUNDAY 9 NOVEMBER

266	Forest Gate Jn and Barking Station (Country End)	Down and Up/ Down and Up Tilbury and Up Goods Loop BLOCKED	00 50 to 06 15.	Overhead line work and bridgework (No. 14A). Crane and mechanical equipment in use. <u>Isolation of electrical sections 512 and 513. Possession to be given up for passage of Engineers' trains.</u>
-----	--	--	-----------------	--

SECTION B - TEMPORARY ENGINEERING WORKS - continued

At or between	Lines affected	Remarks
---------------	----------------	---------

FENCHURCH STREET TO SHOEBURYNESS - continued

SUNDAY 9 NOVEMBER - continued

267	Laindon and Pitsea	Up BLOCKED Down BLOCKED	00 01 to 05 45)Track maintenance)and drainage. 01 15 to 07 15))
268	Leigh-on-Sea and Pitsea	Up BLOCKED	08 00 to 18 00. Painting station and repairs to platform awnings (Benfleet Station). <u>Isolation of electrical sections 521AB. Single line working over Down line.</u>
269	Leigh-on-Sea and Southend Central	Up BLOCKED Down BLOCKED	00 01 to 05 30)Track renewal (No. 102B)points) and painting 01 35 to 07 30)Chalkwell station.) <u>00 01 to 05 30.</u>) <u>Isolation of electrical sections 523, 525C.</u>) <u>01 35 to 07 30.</u>) <u>Isolation of electrical sections 524, 526A.</u>

MONDAY 10 NOVEMBER

270	Christian Street Jn. and East Ham (London End)	Down and Up BLOCKED	00 01 to 06 00. Overhead line work. <u>Isolation of electrical sections 505, 506, 507 and 508.</u>
-----	--	------------------------	--

MONDAY/TUESDAY 10/11 NOVEMBER

271	Leigh-on-Sea and Pitsea	Up BLOCKED	23 30 to 04 30. Rail grinding. 29m.p. and 29m. 30chs. Mechanical equipment in use. <u>Sparks may be emitted during grinding operations.</u> <u>Single line working over Down line.</u>
-----	-------------------------	---------------	---

MONDAY 10 TO SATURDAY 15 NOVEMBER

272	Fenchurch Street Station	Platforms 1,2,3 and 4 BLOCKED	21 15 Mon to Fri to 06 00 Tue to Sat. Construction work. Mechanical equipment in use.
-----	--------------------------	----------------------------------	---

SECTION B - TEMPORARY ENGINEERING WORKS - continued

At or between	Lines affected	Remarks
---------------	----------------	---------

FENCHURCH STREET TO SHOEBURYNESS - continued

MONDAY 10 TO SATURDAY 15 NOVEMBER - continued

273	Fenchurch Street and Gas Factory Jn.	All BLOCKED	21 15 Mon to Fri to 06 00 Tue to Sat. Repairs to platform awnings (Stepney East Station), construction work and painting Stepney East Station. <u>Isolation of electrical sections 501, 502, 503 and 504.</u>
274	Gas Factory Jn and East Ham (London End)	Down and Up BLOCKED	21 15 Mon to Fri to 06 00 Tue to Sat. Track maintenance and undertrack excavation. Mechanical equipment in use. <u>Isolation of electrical sections 505, 506, 507 and 508.</u>
275	Upminster and Pitsea	Up BLOCKED Down BLOCKED	23 45 Mon to Fri to 04 25 Tue to Sat) Overhead line work. Mechanical equipment in use.) <u>Isolation of electrical sections 517 and 519.</u> 23 45 Mon to Fri to 01 15 Tue to Sat. Up trains diverted via Grays.)01 15 to 04 25 Tue to Sat. Isolation of electrical sections 518 and 520. Trains diverted via Grays.

TUESDAY 11 TO FRIDAY 14 NOVEMBER

276	Barking and Upminster	Down and Up Main BLOCKED	01 00 to 04 15 daily. Track maintenance and loading materials. Mechanical equipment in use. <u>Trains diverted via Grays.</u>
-----	-----------------------	-----------------------------	---

GAS FACTORY JN TO BOW JN

FRIDAY/SATURDAY 7/8 NOVEMBER

277	Gas Factory Jn and Bow Jn	Single BLOCKED to electric trains	21 15 to 06 00. In connection with engineering work. <u>Isolation of electrical sections 506A.</u>
-----	---------------------------	--------------------------------------	--

SECTION B - TEMPORARY ENGINEERING WORKS - continued

At or between	Lines affected	Remarks
<u>GAS FACTORY JN TO BOW JN - continued</u>		
MONDAY 10 NOVEMBER		
278 Gas Factory Jn and Bow Jn	Single BLOCKED to electric trains	00 01 to 06 00. In connection with overhead line work between Christian Street Jn and East Ham. <u>Isolation of electrical sections 506.</u>
<u>UPPER HOLLOWAY TO BARKING, TILBURY LINE JN WEST</u>		
UNTIL FURTHER NOTICE		
279 Upper Holloway and Crouch Hill Station	Down and Up	Earthwork. 3m 41chs. and 3m 43chs. Mechanical equipment in use. (85/64)
280 Wanstead Park Station	Up	08 00 to 16 00. Platform work. <u>(See Section 'D')</u> . (85/50)
281 Woodgrange Park and Barking Station Jn	Down and Up <u>Between Trains</u>	07 30 to 18 00. Bridgework (No. 6). 12m. 26chs. Crane and mechanical equipment in use. (85/62)
282 Woodgrange Park and Barking Tilbury Line Jn West	Down and Up	Erecting scaffolding in connection with bridge No. 14A. (85/8)
SUNDAY 9 NOVEMBER		
283 Upper Holloway and Harringay Park Jn	Down and Up BLOCKED	08 00 to 16 30. Track maintenance. 3m. 70chs. and 4m. 10chs. <u>Possession to be given up for passage of empty H.S.T.s between Bounds Green and St. Pancras.</u>
284 South Tottenham East Jn and Woodgrange Park Jn	Down and Up BLOCKED	00 50 to 06 15. Overhead line work. Mechanical equipment in use.
285 Forest Gate Jn. and Barking Station (Country End)	Down and Up/ Down and Up Tilbury and Up Goods Loop BLOCKED	00 50 to 06 15. Overhead line work and bridgework (No. 14A). Crane and mechanical equipment in use. <u>Isolation of electrical sections 512 and 513. Possession to be given up for passage of Engineers' trains.</u>

SECTION B - TEMPORARY ENGINEERING WORKS - continued

At or between	Lines affected	Remarks
---------------	----------------	---------

BARKING, TILBURY LINE JN EAST TO TILBURY RIVERSIDE

UNTIL FURTHER NOTICE

286	Dagenham Dock Station	Down and Up	08 00 to 17 00. Construction work. Mechanical equipment in use. (85/14)
287	Rainham Station	Down and Up	08 00 to 17 00. Construction work. Mechanical equipment in use. (85/14)
288	Purfleet Station	Down and Up	09 00 to 16 00. Platform work. Mechanical equipment in use. (85/61)

SUNDAY 9 NOVEMBER

289	West Thurrock Jn. and Barking Tilbury Line Jn West	Up Main BLOCKED	00 45 to 06 50. Rail grinding 14 $\frac{1}{2}$ and 13 $\frac{1}{2}$ m.p. Mechanical equipment in use. <u>Sparks may be emitted during grinding operations.</u>
290	West Thurrock Jn and Tilbury Riverside	All BLOCKED	01 15 to 07 00. Track maintenance. Mechanical equipment in use.

TILBURY RIVERSIDE TO PITSEA

SUNDAY 9 NOVEMBER

291	Tilbury Riverside and Pitsea	Down and Up BLOCKED	01 15 to 18 00. Track maintenance, overhead line work, unloading materials and undertrack excavation. <u>Mechanical equipment in use.</u> <u>Isolation of electrical sections 536 and 537.</u>
-----	------------------------------	------------------------	---

SUNDAY/MONDAY 9/10 NOVEMBER

292	Tilbury East Jn and Stanford-le-Hope	Down BLOCKED	23 15 to 05 15. Rail grinding 23m. 30chs. and 24 $\frac{1}{2}$ m.p. Mechanical equipment in use. <u>Sparks may be emitted during grinding operations.</u> <u>Single line working over Up line.</u>
-----	--------------------------------------	-----------------	---

SECTION CSIGNALLING AND PERMANENT WAY ALTERATIONS

* * Items marked thus will not appear in future issues and a note must be
* taken of them by all concerned.

DETAILS OF WORK REFERRED TO IN SECTION BSUNDAY 9 NOVEMBER - BETWEEN HETHERSETT AND TROWSE LOWER JUNCTIONHethersett

The Down Main semaphore Starting Signal will be replaced by a 2-aspect (RED/GREEN) colour light signal plated HT13, 35 yards further from the signal box.

The Up Main Home 2-aspect colour light signal No. HTB will be repositioned 1,350 yards further from the signal box on a new right-hand bracket post.

The Up Main colour light Distant signal No. HTA (together with its associated A.W.S. track inductor) will be repositioned 1¼ miles further from the signal box to a position 2,037 yards before reaching the repositioned Up Home signal.

Reference should be made to the associated diagram included in this notice.

Level Crossings

Intwood Automatic Half-barrier Level Crossing at 119m. 47chs.

Keswick Automatic Half Barrier Level Crossing at 120m.p.

The barriers at these crossings will be equipped to work automatically when approached in the reverse direction and for this purpose, combined St. Andrew's Cross/30m.p.h. speed restriction signs will be provided applicable to each rail approach to the crossings in the wrong direction.

Eaton Minature Warning Lights Level Crossing at 120m. 29chs.

A combined St. Andrew's Cross/30m.p.h. speed restriction sign will be provided applicable to each wrong direction rail approach to Eaton Level Crossing.

A 'Whistle' board will be provided on each rail approach for normal and wrong direction of travel.

The distance of the St. Andrew's Cross/speed restriction signs and 'Whistle' boards from the three level crossings is as shown on the diagram.

SECTION C - SIGNALLING AND PERMANENT WAY ALTERATIONS - continued

DETAILS OF WORK REFERRED TO IN SECTION B - continued

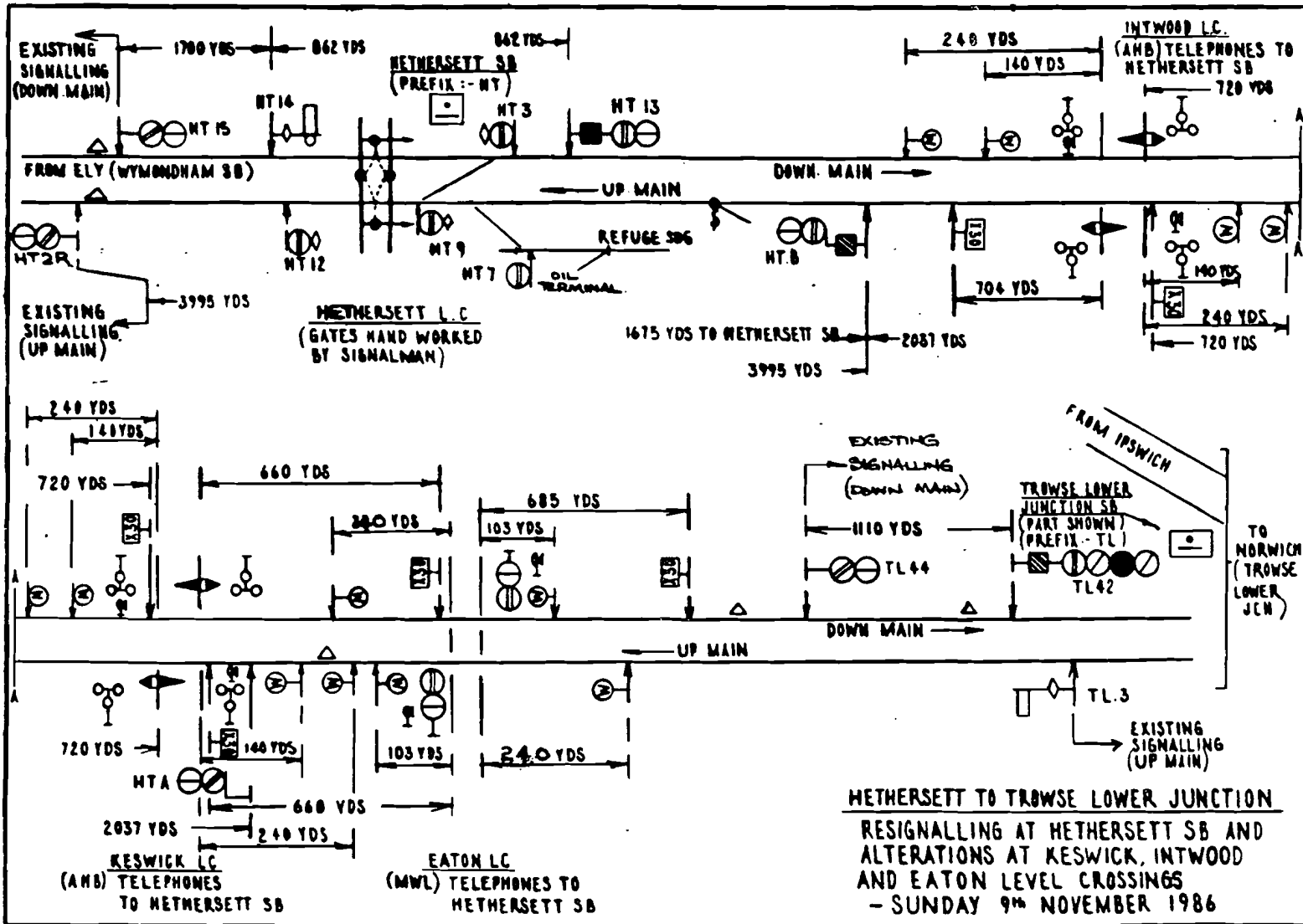

SECTION C - SIGNALLING AND PERMANENT WAY ALTERATIONS - continuedDETAILS OF WORK REFERRED TO IN SECTION B - continuedSUNDAY 9 NOVEMBER - AUDLEY END

3-aspect signal CA47, reading from the Up Main to Down Main at the north end of Audley End Up Platform, will be fitted with AWS equipment, 100 yards on the approach side of the signal.

(36)

MONDAY 10 NOVEMBER - BETWEEN GAS FACTORY JN AND EAST HAM

The 60 m.p.h. Permanent Speed Restriction on the Down line between 2m. 73chs. and 6 $\frac{1}{2}$ m.p. will be withdrawn and the following Permanent Speed Restrictions will then apply on the Down line:-

60 m.p.h. between 2m. 73chs. and 3m. 12chs.

70 m.p.h. between 3m. 12chs. and 6m.p.

60 m.p.h. between 6m.p. and 6 $\frac{1}{2}$ m.p.

(See Section 'D') (36)

DETAILS OF WORK ALREADY CARRIED OUTNEW HALL

The Up Loop has been taken out of use Until Further Notice.

(UFN)

HATFIELD PEVEREL

The facing and trailing crossovers are out of use until further notice.

(UFN)

BETWEEN SWAINSTHORPE AND TROWSE LOWER JUNCTION

Swainsthorpe signal box, together with all signalling worked therefrom has been abolished.

New colour light signalling has been commissioned in accordance with the diagram included in this notice.

Except for the section between Trowse Lower Junction (Trowse Yard if open) and Trowse Swing Bridge, which is signalled in accordance with the Absolute Block Regulations, the Track Circuit Block Regulations now apply throughout between Colchester and Trowse Lower Junction, and between Trowse Swing Bridge and Norwich.

SECTION C - SIGNALLING AND PERMANENT WAY ALTERATIONS - continuedDETAILS OF WORK ALREADY CARRIED OUT - continuedBETWEEN SWAINSTHORPE AND TROWSE LOWER JUNCTION - continuedAlterations to Existing Signalling

Trowse Lower Junction Up Branch (former Starting) signal No.TL5 has been converted to a 3-aspect signal.

Level CrossingsSwainsthorpe Level Crossing at 109m. 54chs.

This crossing has been converted to an automatic half-barrier crossing. Telephone communication has been provided between the crossing and Colchester Signal Box.

The crossing is closed to road traffic and the barriers secured in the lowered position until the associated road works are completed when the barriers will be fully commissioned.

Working in the Wrong Direction

The barriers are equipped to work automatically when approached in the wrong direction, and for this purpose a combined St. Andrew's Cross/50m.p.h. speed restriction sign has been provided 955 yards from the crossing on each rail approach in the wrong direction.

Newton Flotman Automatic Half-Barrier Level Crossing at 108m. 19chs.

The telephones at this crossing have been altered to communicate with Colchester S.B. (previously to Swainsthorpe S.B.).

Catchpoints

The catchpoints in the Up Main at 113m. 21chs. and at 113m. 61chs. (between Trowse Lower Junction and the site of former Trowse Upper Junction), have been secured in the closed position pending removal and replacement by plain line.

Automatic Warning System

A.W.S. has been provided in conjunction with all main line colour light signals.

(34)

* * TROWSE YARD

*

The trailing connection leading from the Down Main to Down Sidings has been secured out of use pending removal of the points and of the Down Sidings (Warehouse Loading Dock).

All associated signalling has been abolished.

(33)

SECTION C - SIGNALLING AND PERMANENT WAY ALTERATIONS - continuedDETAILS OF WORK ALREADY CARRIED OUT - continuedNORWICH STATION

No. 1 Platform line has been shortened by 5 yards and new buffer stops installed.

(34)

WOODHAM FERRERS AUTOMATIC OPEN LEVEL CROSSING AT 34M. 05CHS.

A Plunger (housed in a locked cabinet) has been provided attached to the post carrying the Down side Drivers flashing white light signal.

When the train is ready to depart and the Drivers white light is not illuminating, (providing the train is standing on the Down Platform line,), in order to reactivate the road traffic signals which may have extinguished on account of power failure or have been 'Timed-out', the Driver should unlock the cabinet by means of the Drivers No. 1 key and press the Plunger.

(35)

SECTION C - SIGNALLING AND PERMANENT WAY ALTERATIONS - continued

DETAILS OF WORK ALREADY CARRIED OUT - continued

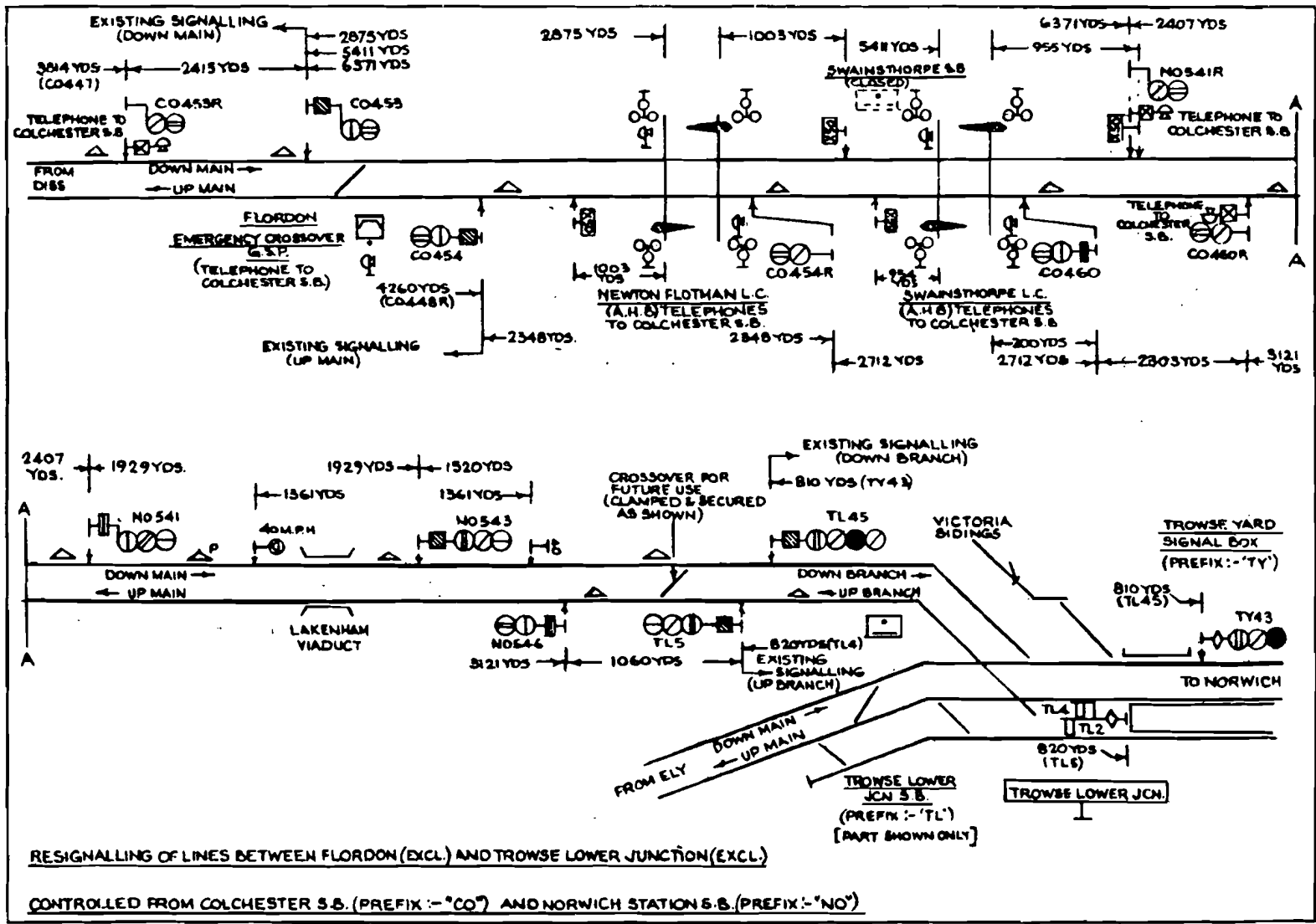

SECTION D

GENERAL INSTRUCTIONS AND NOTICES

A thick vertical line denotes new or amended items.

* * Items marked thus will not appear in future issues and a note must be taken of them by all concerned.
*



EASTERN REGION SECTIONAL APPENDIX (SOUTHERN AREA)

TABLE A : DETAILS OF RUNNING LINES

Running Lines and Signalling System	Location	M. Ch.	Permanent Speed Restrictions		Remarks
			Down m.p.h.	Up m.p.h.	
<u>LIVERPOOL STREET TO NORWICH</u> <u>Page 57</u> (Page 23, SD PON) At Colchester (CO) <u>Amend</u> 'Remarks' column entry to read:-					Colchester (CO) signal box area between Colchester and Swainsthorpe.

SECTION D - GENERAL INSTRUCTIONS AND NOTICES - continued

EASTERN REGION SECTIONAL APPENDIX (SOUTHERN AREA) - continued

Running Lines and Signalling System	Location	M. Ch.	Permanent Speed Restrictions		Remarks
			Down m.p.h.	Up m.p.h.	
<u>LIVERPOOL STREET TO NORWICH - continued</u>					
Page 60 (Page 23, SD PON)					
At Haughley LC (AHB)					
<u>Amend</u> 'Remarks' column entry to read:-					
Pages 60 and 61 (Pages A29 and 24, SD PON)					
<u>Delete</u> all details between Mellis LC (AHB-X) and Trowse Lower Jn and <u>substitute</u> :-					
 	Mellis LC (AHB-X)	91 34	X50	X50	<u>Approaching level crossing in wrong direction.</u> Telephone to Colchester signal box at 92m. 77chs. (Signal CO 424R).
					Telephones to Colchester signal box are provided at all 2 aspect distant signals between 82½m.p. and 90m.p.

SE-56

SECTION D - GENERAL INSTRUCTIONS AND NOTICES - continued

EASTERN REGION SECTIONAL APPENDIX (SOUTHERN AREA) - continued

Running Lines and Signalling System	Location	M. Ch.	Permanent Speed Restrictions		Remarks
			Down m.p.h.	Up m.p.h.	
<u>LIVERPOOL STREET TO NORWICH - continued</u>					
Pages 60 and 61 (Pages A29 and 24, SD PON) - continued:-					
<u>Delete</u> all details between Mellis LC (AHB-X) and Trowse Lower Jn and <u>substitute</u> - continued:-					
	Palgrave LC (AHB-X)	94 04	X50	X50	<u>Approaching level crossing in wrong direction.</u>
	Diss	94 79			
	Audley End (Norfolk) LC (AHB-X)	97 05	X50	X50	<u>Approaching level crossing in wrong direction.</u>
	Burston LC (AHB-X)	97 42	X50	X50	<u>Approaching level crossing in wrong direction.</u>

SECTION D - GENERAL INSTRUCTIONS AND NOTICES - continued

EASTERN REGION SECTIONAL APPENDIX (SOUTHERN AREA) - continued

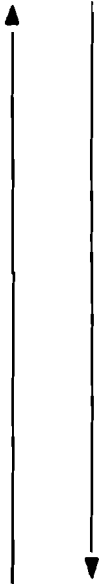
Running Lines and Signalling System	Location	M. Ch.	Permanent Speed Restrictions		Remarks
			Down m.p.h.	Up m.p.h.	
<u>LIVERPOOL STREET TO NORWICH - continued</u>					
Pages 60 and 61 (Pages A29 and 24, SD PON) - continued:-					
<u>Delete</u> all details between Mellis LC (AHB-X) and Trowse Lower Jn and <u>substitute</u> - continued:-					
	Gissing LC (AHB-X)	98 57	X50	X50	<u>Approaching level crossing in wrong direction.</u>
	Hales Street LC (AHB-X)	100 27	X50	X50	<u>Approaching level crossing in wrong direction.</u>
	Tivetshall LC (AHB-X)	100 43	X50	X50	<u>Approaching level crossing in wrong direction.</u>
	Moulton LC (AHB-X)	101 51	X50	X50	<u>Approaching level crossing in wrong direction.</u>
	Flordon	106 63			
					Telephones to Colchester signal box at 104m. 41chs. (Signal CO 448R) and at 105m. 19chs. (Signal CO 453R).

SECTION D - GENERAL INSTRUCTIONS AND NOTICES - continued

EASTERN REGION SECTIONAL APPENDIX (SOUTHERN AREA) - continued

Running Lines and Signalling System	Location	M. Ch.	Permanent Speed Restrictions		Remarks
			Down m.p.h.	Up m.p.h.	
<u>LIVERPOOL STREET TO NORWICH - continued</u>					
Pages 60 and 61 (Pages A29 and 24, SD PON) - continued:-					
<u>Delete all details between Mellis LC (AHB-X) and Trowse Lower Jn and substitute - continued:-</u>					
	Newton Flotman LC (AHB-X)	108 19	<u>X50</u>	<u>X50</u>	<u>Approaching level crossing in wrong direction.</u>
	Swainsthorpe LC (AHB-X)	109 54	<u>X50</u>	<u>X50</u>	<u>Approaching level crossing in wrong direction.</u>
				<u>90</u>	<u>111m. 15chs. and 110m. 55chs.</u>
				<u>80</u>	<u>111m. 15chs. and 112m. 62chs.</u>
				<u>40</u>	<u>112m. 62chs. and 113m. 46chs.</u>
			<u>35</u>	<u>113m. 46chs. and 123m.p.</u>	
	Trowse Lower Jn (See page 103)	<u>113 68</u> <u>123 00</u>			Telephones to Colchester signal box at 110m. 16chs. (Signal NO 541R) and at 111m. 07chs. (Signal CO 460R). Norwich (NO) signal box area between Swainsthorpe (exclusive) and Trowse Lower Jn (exclusive).

SE-59

(12.SD)

SECTION D - GENERAL INSTRUCTIONS AND NOTICES - continued

EASTERN REGION SECTIONAL APPENDIX (SOUTHERN AREA) - continued

Running Lines and Signalling System	Location	M. Ch.	Permanent Speed Restrictions		Remarks
			Down m.p.h.	Up m.p.h.	
<p><u>BETHNAL GREEN JN TO KING'S LYNN</u></p> <p><u>Page 82</u> (Page 35, SD PON)</p> <p>At Reading Lane Jn</p> <p><u>Amend:-</u></p>			10		<p><u>To Graham Road Curve line.</u></p> <p>(12.SD)</p>
<p><u>READING LANE JN TO NAVARINO ROAD JN (GRAHAM ROAD CURVE)</u></p> <p><u>Page 88</u> (Page 38, SD PON)</p> <p><u>Delete</u> all details and <u>substitute:-</u></p>	<p>Reading Lane Jn (See page 82)</p>	2 55	30	30	<p>MAXIMUM PERMISSIBLE SPEED</p> <p><u>2m. 55chs. and 2m. 71chs.</u></p>
<p>I</p>	<p>Navarino Road Jn (See page 63)</p>	2 79			<p>Controlled by Dalston Western Jn. (DW) signal box.</p> <p>(12.SD)</p>

SE-60

SECTION D - GENERAL INSTRUCTIONS AND NOTICES - continued

EASTERN REGION SECTIONAL APPENDIX (SOUTHERN AREA) - continued

Running Lines and Signalling System	Location	M. Ch.	Permanent Speed Restrictions		Remarks
			Down m.p.h.	Up m.p.h.	
<p><u>ELY NORTH JN TO PETERBOROUGH, CRESCENT JN</u></p> <p><u>Page 97</u></p> <p>At Norwood Road LC</p> <p><u>Amend</u> 'Remarks' columns entry to read :-</p>					<p>UGL.76.</p> <p>(12.SD)</p>

SECTION D - GENERAL INSTRUCTIONS AND NOTICES - continued

EASTERN REGION SECTIONAL APPENDIX (SOUTHERN AREA) - continued

Running Lines and Signalling System	Location	M. Ch.	Permanent Speed Restrictions		Remarks	
			Down m.p.h.	Up m.p.h.		
<p><u>ELY NORTH JN TO TROWSE LOWER JN</u></p> <p><u>Page 103</u></p> <p><u>Delete</u> all details between Hethersett and Trowse Lower Jn and <u>substitute:-</u></p>						
	Hethersett (HT) LC	117 73			<p>URS 48 C. Up at 118m. 48chs. (457 yards after passing signal HT B).</p>	
	Intwood LC (AHB-X)	119 47	X30	X30		<u>Approaching level crossing in wrong direction.</u>
	Keswick LC (AHB-X)	120 00	X30	X30		<u>Approaching level crossing in wrong direction.</u>
	Eaton LC (R/G-X)	120 29	X30	X30		<u>Approaching level crossing in wrong direction.</u>
	Trowse Lower Jn (See page 61)	123 00				
					(W.e.f. Sunday 9 November) (12.SD)	

SE-62

SECTION D - GENERAL INSTRUCTIONS AND NOTICES - continued

EASTERN REGION SECTIONAL APPENDIX (SOUTHERN AREA) - continued

Running Lines and Signalling System	Location	M. Ch.	Permanent Speed Restrictions		Remarks
			Down m.p.h.	Up m.p.h.	
<p><u>FENCHURCH STREET TO SHOEBURYNESS</u></p> <p><u>Pages 104 and 105</u></p> <p><u>Delete all details between Gas Factory Jn and East Ham and substitute:-</u></p>					
	Gas Factory Jn (See page 107)	2 57	<u>20</u>		<u>To Bow Jn line.</u>
	OHNS	3 75	<u>60</u>		<u>2m. 73chs. and 3m. 12chs.</u>
			<u>70</u>		<u>3m. 12chs. and 6m.p.</u>
			<u>60</u>		<u>6m.p. and 2m. 73chs.</u>
	East Ham	6 40	<u>40</u>		<u>6m.p. and 6½m.p.</u>
			<u>55</u>		<u>6½m.p. and 7m. 08chs.</u>
					<u>6m. 50chs. and 6m.p.</u>
					<u>(W.e.f. Monday 10 November)</u>

SE-63

(12.SD)

SECTION D - GENERAL INSTRUCTIONS AND NOTICES - continued

EASTERN REGION SECTIONAL APPENDIX (SOUTHERN AREA) - continued

Running Lines and Signalling System	Location	M. Ch.	Permanent Speed Restrictions		Remarks
			Down	Up	
			m.p.h.		At or Between
<u>FENCHURCH STREET TO SHOEBURYNESS - continued</u>					
<u>Page 105</u>					
<u>Delete:-</u>	Dagenham East GF's	11 25			
					(12.SD)
<u>TILBURY RIVERSIDE TO PITSEA</u>					
<u>Amend:-</u>	Fobbing LC (AHB)	30 34			
					(12.SD)

SE-64

SECTION D - GENERAL INSTRUCTIONS AND NOTICES - continuedEASTERN REGION SECTION APPENDIX (SOUTHERN AREA) - continuedINSTRUCTIONS RELATING TO THE RULE BOOK

Page 264 (Pages 49 and 50, SD PON)

POWER OPERATED POINTS - WRONG DIRECTION MOVEMENTS

<u>Signalbox/location</u>	<u>Point Nos.</u>	
<u>Amend East Gate Jn entry to read :-</u>		
East Gate Jn	25,29	(12.SD)

OTHER GENERAL INSTRUCTIONS

Page 297 (Page A37, SD PON)

DOCKLANDS LIGHT RAILWAY LINE BETWEEN BOW JN AND STRATFORD STATION
(ADJACENT TO THE B.R. UP ELECTRIC LINE)Amend end of first paragraph to read:-

, except that reference to Electrical Control Operator should be read as Controller and Supervisor at Poplar Control Centre, who can be contacted via the Signaller at Bow Jn or Stratford or the Electrical Control Operator at Romford or on British Telecom 538 3440.

(12.SD)

LOCAL INSTRUCTIONS

Page 317

WICKFORD TO SOUTHMINSTERAdd :- WOODHAM FERRERS A.O.C.L. LEVEL CROSSING

Woodham Ferrers level crossing must be worked in accordance with the General Appendix Instructions for A.O.C.L. level crossings, except that in the event of the red road signals not being automatically initiated, the Driver must press the plunger located in a locked Cabinet (Drivers No. 1 Key) on the White light post to activate the road signals. When the white light is flashing, the Driver may proceed as normal. If, after operation of the plunger, the white light still does not flash, the Driver must proceed in accordance with Clause 3.3 of the instructions.

(12.SD)

SECTION D - GENERAL INSTRUCTIONS AND NOTICES - continuedMISCELLANEOUS NOTICESPERMANENTLY COUPLED D.B. 2 x 45 TONNE VANS

The West German Railways are manufacturing 200 45 tonne 2 axle general merchandise vans which will be permanently coupled in 100 pairs.

Each pair of wagons will be identified by a single number in the following range:-

23 80 2794 000-2 to 23 80 2794 099-4

Only one wagon in each pair is fitted with a distributor, and in the event of a coupling breaking the brakes would only apply on the wagon fitted with the distributor - the air supply to the "slave wagon" would be lost when the pipes parted.

For this reason:-

1. These wagons must not be included in a fully fitted block train of this type of wagon.
2. These wagons must not be included in the rear-most three positions of any other fully fitted freight train.
3. Any train including a pair of these wagons, must consist of a minimum of 5 vehicles, to avoid these D.B. wagons being in the last three.

The TOPS trainlist programme will be altered as soon as possible to reflect this.

(12.D)

WORKING INSTRUCTIONS FOR A.C. ELECTRIFIED LINES - BR.29987

From 1st December 1986, a new book will take effect which will replace the current edition dated 3rd May 1975 and the amendments thereto.

The book will be in loose leaf form, A5 size, with a flexible cover and its format has been designed so that part of the book can be separately issued in place of the existing "Extracts from the Working Instructions" book BR.29988, which will be discontinued from the same date.

The new book is divided into three main sections viz:-

Section A (BR.29987) - Definitions, Description of System and General Instructions. This will be issued to every employee working on or in the vicinity of lines electrified on the A.C. overhead line system.

Section B (BR.29987/14) - Isolation and Earthing of Overhead Line Equipment.

Section C (BR.29987/15) - Protection of Staff Servicing/Maintaining Locomotives or Trains in Sidings/Depots equipped for electric traction.

SECTION D - GENERAL INSTRUCTIONS AND NOTICES - continuedMISCELLANEOUS NOTICES - continuedWORKING INSTRUCTIONS FOR A.C. ELECTRIFIED LINES - BR.29987 - continued

Note: Sections B and C will be issued only to staff involved with the instructions contained therein.

The new book is currently being distributed and the appropriate section(s), together with a copy of the explanatory leaflet, BR.29987/16, must be made available to staff immediately upon receipt.

Any member of the staff who is in possession of the current issue of the A.C. Working Instructions, or Extracts thereto, who does not receive a copy of the appropriate section(s) of the new book by 10 November must promptly advise his Supervisor.

(36)

GREAT EASTERN ELECTRIFIED LINES : BARKING AREAINSTALLATION OF DEAD SECTION

A DEAD SECTION has been installed at overhead line structure number A7/12 at 7m. 12chs. on the UP MAIN, London side of Barking Flyover.

(12.SD)

WORKING OF CLASS 313 AND CLASS 416 ELECTRIC MULTIPLE UNIT
TRAINS BETWEEN DALSTON WESTERN JN AND STRATFORD MARKETClass 313 Electric Multiple Units

These units must only work between Navarino Road Jn and Stratford Market stabling sidings when either the Graham Road Curve route to Liverpool Street is not available, or when the pantographs have failed to rise. When operating between Dalston Kingsland and Stratford Market stabling sidings and return in the D.C. mode, Drivers must not advance the controller beyond Notch 2.

THESE UNITS MUST NOT RUN BEYOND STRATFORD MARKET TOWARDS NORTH WOOLWICH.

Class 416 Electric Multiple Units

Not more than two Class 416 units may be coupled together.

When two Class 416 units are running in multiple between Dalston Western Jn and Stratford Market, including the stabling sidings or return, Drivers must not advance the controller beyond Notch 2.

(UFN)

SECTION D - GENERAL INSTRUCTIONS AND NOTICES - continued

MISCELLANEOUS NOTICES - continued

BETWEEN STEPNEY EAST AND FENCHURCH STREET

Until further notice, staff of the Docklands Light Railway will be laying in track adjacent to the Up Main/Slow line between Stepney East Station (1m. 58chs.) and Fenchurch Street. Restricted clearances exist and Drivers must keep a sharp look out and be prepared to sound the warning horn as necessary.

(UFN)

BETHNAL GREEN STATION

Until Further Notice, whilst demolition work is taking place, Drivers of 4-Car EMU trains must stop their trains at the temporary stop boards provided.

(UFN)

CAMBRIDGE HEATH STATION

Whilst platform repairs are taking place, Drivers of trains must stop their trains at the temporary stop boards provided.

(UFN)

LONDON FIELDS STATION

The station has reopened but platform repairs are taking place. Whilst this work is being carried out, Drivers must stop their trains at the temporary stop boards provided.

(UFN)

SAWBRIDGEWORTH STATION

The stop board on the Up platform has been temporarily moved 9 yards towards the Country side of its former position.

(UFN)

WANSTEAD PARK STATION

Whilst platform repairs are taking place, Drivers of Up trains must stop their trains at the temporary stop boards provided.

(UFN)

SECTION D - GENERAL INSTRUCTIONS AND NOTICES - continuedMISCELLANEOUS NOTICES - continuedREPAIRS IN MOTIVE POWER DEPOTS, CARRIAGE SHEDS, WAGON REPAIR SHEDS AND WAREHOUSES

In connection with work being carried out at the undermentioned places, scaffolding or projections may be provided or unusual excavations may be made in the ground:-

Location	Nature of Work	Duration	Commencing date
Stratford T.M.D. All lines.	Repairs to Motive Power Depot. Cranes and mechanical equipment in use.	Continuously. Until Further Notice.	-
Ilford EMU Depot, Nos. 19 and 20 Roads.	Drainage.	08 00 to 17 00 daily. Until Further Notice.	-
Ilford EMU Depot, 'B' Shop Roads Nos. 3, 4 and 5.	Construction work. <u>Isolation of electrical sections C3, 4 and 5.</u>	Continuously. Until further notice.	-
Ilford EMU Depot, Nos. 6, 7, 8, 9 and 10 Sidings (Country End) BLOCKED	Track renewal.	Continuously. Until further notice.	-
Ilford EMU Depot, Nos. 6 to 11 inc. Sidings BLOCKED Nos. 12,13,14,15 and 16 sidings BLOCKED to electric trains	Track maintenance and track renewal. <u>Isolation of electrical sections 361H.</u>	10 00 to 15 00 daily.	<u>From Wednesday</u> <u>12 until</u> <u>Thursday 13</u> <u>November.</u>
Norwich Crown Point T & R.S. M.D., All lines BLOCKED	Construction work (overhead line) and track maintenance. Mechanical equipment in use. <u>Possession</u> <u>to be given up for</u> <u>passage of trains.</u>	08 00 to 17 00 daily. Until further notice.	-
East Ham EMU Depot, All lines.	Shed reconstruction.	Continuously. Until Further Notice.	-

SECTION D - GENERAL INSTRUCTIONS AND NOTICES - continuedMISCELLANEOUS NOTICES - continuedREPAIRS IN MOTIVE POWER DEPOTS, CARRIAGE SHEDS, WAGON REPAIR SHEDS AND WAREHOUSES

In connection with work being carried out at the undermentioned places, scaffolding or projections may be provided or unusual excavations may be made in the ground:-

Location	Nature of Work	Duration	Commencing date
East Ham EMU Depot, Washer Road BLOCKED	Repairs to washer plant. <u>Isolation of electrical sections 509A.</u>	Continuously. Until Further Notice.	-
East Ham EMU Depot, Nos. 10 and 11 Maintenance Shed Roads BLOCKED	Construction work. <u>Isolation of electrical sections EH10, EH11.</u>	Continuously. Until Further Notice.	-
Shoeburyness CSD, No. 16 Road BLOCKED	Cleaning Admin. Block windows. <u>Isolation of electrical sections 529A.</u>	10 00 to 12 00. <u>Thursday 13 November.</u>	-

MP.32/SE
YORK
30 OCTOBER, 1986

C. McKEEVER
Regional Operations Manager

BRITISH RAIL
EASTERN REGION

SE

34

WEEKLY OPERATING NOTICE

CONTAINING

TEMPORARY SPEED RESTRICTIONS

TEMPORARY ENGINEERING WORKS

SIGNALLING AND
PERMANENT WAY ALTERATIONS

GENERAL INSTRUCTIONS AND NOTICES

SATURDAY 15 NOVEMBER

TO

FRIDAY 21 NOVEMBER 1986

INCLUSIVE

Trainmen must pay particular attention to works contained in this notice and keep a good look-out for handsignals which may be exhibited in accordance with the Rules and Regulations.

Work at places other than those mentioned may be in progress and Drivers must be on the look-out and be prepared to stop or run at reduced speed when, and where, handsignals may be exhibited.



WARNING



*
*
* ENERGISATION OF DOCKLANDS LIGHT RAILWAY BETWEEN *
* DELTA JUNCTION, STEPNEY EAST, CHRISTIAN STREET *
* JUNCTION AND TOWER GATEWAY. (ADJACENT TO *
* B.R. FENCHURCH STREET TO BARKING LINE). *
*
* From 00 01 hours on Monday 17 November, 1986, the Conductor *
* Rails between Delta Junction and Tower Gateway will be energised *
* at 750 volts D.C. and must thereafter be regarded as 'ALIVE' at *
* all times. *
*
* (12.SD) *
*

SECTION A

TEMPORARY SPEED RESTRICTIONS

(Until further notice unless otherwise specified)

Warning Boards and Indicators provided unless otherwise shown.

† Indicates that the Warning Boards and Indicators will be moved as the work progresses. Where two speeds are shown for a restriction e.g. 20 the Rule Book, Section U, Clause 1.2 applies. 40

 *
 * RULE BOOK : SECTION U *
 *
 * An experimental speed indicator board with black figures on a yellow *
 * background will be used in the Warning Board and Speed Indicator *
 * board for the following Temporary Speed Restriction:- *
 *
 * Church Lane LC Down Up 29 24 29 57 20 Trackwork. *
 * and Chelmsford *
 *
 * In addition to the above equipment an experimental black and white *
 * zebra striped board with twin high powered flashing white lights *
 * will be located at the A.W.S. temporary magnet for the Temporary *
 * Speed Restriction shown above. This board with lights does not *
 * affect the conditions for Drivers working over the Temporary Speed *
 * Restriction, being located only for the purpose of obtaining *
 * reactions to their effectiveness for sighting. *
 *
 * Drivers and Traction Inspectors encountering the experimental *
 * indicators are requested to submit their comments to the Regional *
 * Operations Manager, York under reference MO45/1274 via their *
 * Local Supervisor. *
 *

Location	Lines affected		Mileage		Restr- iction	Remarks
			M. Ch.	M. Ch.		
<u>LIVERPOOL STREET TO NORWICH</u>						
1 Bethnal Green Station Jn and Bow Jn	Down Main	Up Main	1 60	2 10	20	Trackwork. (86/33)
2 Bow Jn	Down Main	Up Main	2 60	2 69	40	Bridgework (No. 46). (86/32) <u>Until 11 00</u> <u>Sunday 16</u> <u>November.</u>

SECTION A - TEMPORARY SPEED RESTRICTIONS - continued

Location	Lines affected	Mileage		Restr- iction m.p.h.	Remarks	
		at or between M. Ch. M. Ch.				
<u>LIVERPOOL STREET TO NORWICH - continued</u>						
3 Bow Jn	Down Main	-	2 60	2 69	20	Bridgework (No. 46). <u>From 11 00</u> <u>Sunday 16</u> <u>November.</u> (86/34)
4 Bow Jn	Down Electric	-	2 60	2 69	20	Bridgework (No. 46). (86/31)
5 Bow Jn	-	Up Main	2 69	2 60	20	Bridgework (No. 46). <u>Warning</u> <u>board also</u> <u>provided on</u> <u>Up Cambridge</u> <u>line at</u> <u>3m. 12chs.</u> <u>From 11 00</u> <u>Sunday 16</u> <u>November.</u> (86/34)
6 Bow Jn	-	Up Electric	2 69	2 60	20	Bridgework (No. 46). <u>Warning</u> <u>board also</u> <u>provided on</u> <u>Up Main line</u> <u>at 3m. 27chs.</u> <u>Until 11 00</u> <u>Sunday 16</u> <u>November.</u> (86/31)

SECTION A - TEMPORARY SPEED RESTRICTIONS - continued

Location	Lines affected		Mileage		Restr- iction	Remarks
			at or between			
			M.	Ch. M.	Ch.	m.p.h.
<u>LIVERPOOL STREET TO NORWICH - continued</u>						
7 Bow Jn	-	Up Electric	2 69	2 60	20	Bridgework (No. 46). <u>Warning boards also provided on Up Main line at 3m. 27chs. and on Up Cambridge line at 3m. 12chs. From 11 00 Sunday 16 November.</u> (86/34)
8 Harold Wood and Brentwood	Down Main	-	15 02 †	15 75	20	Trackwork. <u>Until 14 00 Friday 21 November.</u> (86/31)
9 Harold Wood and Brentwood	Down Main	-	16 24	16 44	40	Trackwork. <u>From 14 00 Monday 17 until 10 00 Friday 21 November.</u>
10 Brentwood and and Harold Wood	-	Up Main	15 75 †	15 02	40	Trackwork. <u>Until 14 00 Friday 21 November.</u> (86/31)
11 Brentwood and Ingatestone	Down Main	-	19 65	20 33	50	Condition of track. (86/14)
12 Church Lane LC and Chelmsford	Down	Up	29 24	29 57	20	Trackwork. (86/26)
13 Chelmsford and New Hall G.F.	Down	-	30 50	30 65	50	Condition of track. (86/12)

SECTION A - TEMPORARY SPEED RESTRICTIONS - continued

Location	Lines affected		Mileage		Restr- iction m.p.h.	Remarks
			at or between M. Ch. M. Ch.			
<u>LIVERPOOL STREET TO NORWICH - continued</u>						
14 New Hall G.F. and Witham	Down	-	35 65	36 20	30	Trackwork. From 23 00 <u>Saturday 15</u> <u>until 16 00</u> <u>Sunday 16</u> <u>November.</u>
15 Witham and New Hall G.F.	-	Up	36 20	35 65	20	Earthwork. (86/28)
16 Hatfield Peverel and Witham	Down	-	37 20 †	38 00	40	Condition of track. (86/28)
17 Kelvedon	-	Up	42 25	42 10	<u>50</u> 80	Condition of track. (86/7)
18 Palgrave LC and Rectory Road LC	-	Up	91 40	91 20	20	Earthwork. (86/28)
<u>SHENFIELD JN TO SOUTHEND VICTORIA</u>						
19 Billericay and Wickford Station	Down	-	26 10	26 44	40	Condition of track. (86/14)
20 Wick Lane LC and Rayleigh	Down	-	31 35	31 75	40	Condition of embankment. (84/41)
<u>WICKFORD JN TO SOUTHMINSTER</u>						
21 Althorne LC and Burnham-on- Crouch		Single	41 10 †	42 10	20	Trackwork. (85/45)
<u>WITHAM TO BRAINTREE</u>						
22 Cressing and Braintree		Single	18 75	18 68	20	Bridgework (No. 2102B). (86/29)

SECTION A - TEMPORARY SPEED RESTRICTIONS - continued

Location	Lines affected		Mileage		Restr-	Remarks
			at or between	Restr-		
			M. Ch. M. Ch.	m.p.h.		
<u>COLCHESTER TO CLACTON</u>						
23 Colchester Road - LC and Wivenhoe	-	Up	57 72 †	57 12	40	Condition of track. (86/26)
<u>MANNINGTREE SOUTH JN TO HARWICH</u>						
24 Parkeston Goods - Jn and Wrabness	-	Up	66 70	66 10	<u>30</u> 50	Condition of track. (86/3)
<u>EAST SUFFOLK JN TO OULTON BROAD NORTH JN</u>						
25 Bealings LC - and Westerfield Jn	-	Up	74 60 †	73 44	30	Condition of track. (86/33)
<u>WESTERFIELD JN TO FELIXSTOWE</u>						
26 Trimley	Single		82 55	82 69	30	Trackwork. (86/33)
<u>NORWICH TO LOWESTOFT</u>						
27 Thorpe Jn and Whitlingham Jn	Down	Up	0 36	0 44	20	Trackwork. (85/20)
28 Whitlingham Jn and Brundall Jn	Down	Up	4 59 †	5 62	30	Trackwork. Until 22 00 <u>Saturday 15</u> <u>November.</u> (86/33)
29 Brundall Gardens and Brundall Jn	Down	-	5 50	5 65	30	Trackwork. From 22 00 <u>Saturday 15</u> <u>November.</u> (86/34)

SECTION A - TEMPORARY SPEED RESTRICTIONS - continued

Location	Lines affected		Mileage		Restr- iction	Remarks
			M. Ch.	M. Ch.		
<u>BETHNAL GREEN JN TO KING'S LYNN</u>						
30 Tottenham South Jn	Down	-	5 39	5 43	20	Condition of track. (86/32)
31 Angel Road and Brimsdown	Down	Up	9 60	10 02	20	Trackwork. (86/30)
32 Enfield Lock	Down	Up	11 60	11 71	50	Condition of track. (86/31)
33 Sawbridgeworth and Harlow Mill	-	Up	24 76	24 70	60	Condition of track. (86/16)
34 Whittlesford Station	-	Up	49 10	49 00	40	Platform work. (86/29)
<u>HACKNEY DOWNS NORTH JN TO ENFIELD TOWN</u>						
35 Stamford Hill	-	Up	5 12	4 78	20	Condition of track. <u>From 10 00</u> <u>Tuesday 18</u> <u>November.</u> (86/34)
36 Silver Street and Bury Street Jn	Down	Up	8 40	8 67	20	Trackwork. <u>From 14 00</u> <u>Friday 21</u> <u>November.</u> (86/34)
<u>ELY NORTH JN TO PETERBOROUGH, CRESCENT JN</u>						
37 Third Drove LC and Welney Road LC	Down	Up	78 00	78 18	20	Condition of track. (86/21)
38 Third Drove LC and Welney Road LC	Down	Up	78 42	78 60	20	Condition of track. (86/21)

SECTION A - TEMPORARY SPEED RESTRICTIONS - continued

Location	Lines affected		Mileage				Restr- iction m.p.h.	Remarks
			M.	Ch.	M.	Ch.		
<u>ELY NORTH JN TO PETERBOROUGH, CRESCENT JN - continued</u>								
39 March East Jn and Badgeney Road LC	-	Up Main	85	36	85	32	10	Condition of track. <u>Warning board positioned at signal ME.45. Additional warning board provided on the March East Jn to Wisbech line, positioned at signal ME.52. (86/31)</u>
40 Three Horse Shoes No. 3 LC	Down	Up	90	74	90	78	<u>20</u> 50	Condition of track. (86/24)

Warning board at 100m. 25chs. (on the Down line) applies only to trains
proceeding over the Down Fast line at Peterborough Station (North).

ELY NORTH JN TO TROWSE LOWER JN

41 Hethersett and Trowse Lower Jn	Down	-	118	60	120	30	60	Signalling work. (86/33)
42 Trowse Lower Jn and Hethersett	-	Up	121	15	119	47	60	Signalling work. (86/33)
43 Eaton LC and Trowse Lower Jn	Down	Up	121	60	121	64	20	Bridgework (Nos. 1640 and 1640A). (86/23)

FENCHURCH STREET TO SHOE BURYNESS

44 Gas Factory Jn and Barking Tilbury Line Jn West	Down	Up	4	02	4	38	20	Trackwork. (86/31)
---	------	----	---	----	---	----	----	-----------------------

SECTION A - TEMPORARY SPEED RESTRICTIONS - continued

Location	Lines affected		Mileage at or between		Restr- iction m.p.h.	Remarks
			M. Ch.	M. Ch.		
<u>UPPER HOLLOWAY TO BARKING, TILBURY LINE JN WEST</u>						
45 South Tottenham East Jn and Black Horse Road	Down	-	6 45	6 57	20	Condition of track. (85/18)
<u>TILBURY RIVERSIDE TO PITSEA</u>						
46 Stanford-le- Hope and Gardners LC	Down	-	30 11	30 60	40	Condition of track. <u>Until 00 01</u> <u>Sunday 16</u> <u>November.</u> (86/1)
47 Stanford-le- Hope and Gardners LC	Down	-	30 11	30 60	20	Trackwork. <u>From 00 01</u> <u>Sunday 16</u> <u>November.</u> (86/34)
48 Gardners LC and Stanford-le- Hope	-	Up	30 60	30 11	30	Trackwork. <u>From 00 01</u> <u>Sunday 16</u> <u>November.</u> (86/34)

SECTION B

TEMPORARY ENGINEERING WORKS

At or between	Lines affected	Remarks
<u>LIVERPOOL STREET TO NORWICH</u>		
UNTIL FURTHER NOTICE		
49	Liverpool Street Station Platform 1	Demolition work. Mechanical equipment in use. (86/30)
50	Liverpool Street Station Platforms 1 to 10 Inc.	Repairs to station roof. Mechanical equipment in use. (84/41)
51	Liverpool Street Station Platforms 1 to 18 inc.	Cleaning track. (85/21)
52	Liverpool Street Station Platforms 8, 10 and 11 to 18 inc.	Platform work and construction work. Mechanical equipment in use. (86/21)
53	Liverpool Street Platform 10 Shunt Spur BLOCKED	Track maintenance and track renewal. (86/33)
54	Bethnal Green Station Down Main and Down and Up Suburban	08 00 to 16 00. Demolition work. (See Section 'D'). (85/41)
55	Bethnal Green and Bow Jn All	Signalling work. (86/25)
56	Stratford and Bow Jn Up Electric	07 30 to 18 00. Construction work. Mechanical equipment in use. (85/62)
57	Forest Gate Jn and Ilford All	07 00 to 18 00. Bridgework (No. 75A). 7m. 08chs. Mechanical equipment in use. (85/20)
58	Ilford Station All	08 00 to 17 00. Repairs to station roof and painting station. (86/2)
59	Romford Jn and Gidea Park All	Bridgework (No. 102B). 12m. 48chs. Crane and mechanical equipment in use. (85/54)

SECTION B - TEMPORARY ENGINEERING WORKS - continued

<u>At or between</u>	<u>Lines affected</u>	<u>Remarks</u>
<u>LIVERPOOL STREET TO NORWICH - continued</u>		
UNTIL FURTHER NOTICE - continued		
60 Ingatestone and Chelmsford	Down and Up	07 30 to 18 00. Construction of bridge (No. 143A). 26m. 51chs. Mechanical equipment in use. (84/35)
61 Chelmsford and Hatfield Peverel	Down and Up	07 30 to 16 00. Earthwork. 35m. 53chs. (85/27)
62 Colchester Jn and Ardleigh LC	Down Main	08 00 to 17 00. Earthwork and formation renewal. 52m. 25chs. and 53m. 75chs. Mechanical equipment in use. (85/41)
63 Manningtree North Jn and Bentley LC	Down and Up <u>Between Trains</u>	07 00 to 18 00. Tree felling, bridgework (No. 229) and earthwork. 60m. 06chs. and 61m. 06chs. Crane and mechanical equipment in use. (85/15)
64 Ipswich Goods Jn and Needham Market	Down Main	08 00 to 16 00. Construction work. 69% and 76m.p. (86/19)
65 East Suffolk Jn and Claydon LC	Down and Up	08 00 to 16 00. Bridgework (No.254A). 70m. 17chs. (85/58)
66 Mellis LC	Down and Up	07 30 to 18 00. Demolition work. 91%mp. Mechanical equipment in use. (86/12)
67 Mellis LC and Trowse Lower Jn	All <u>Between Trains</u>	07 30 to 18 00. Signalling work. Points and signals disconnected. (86/15)
68 Diss and Mellis LC	Up	08 00 to 15 00. Construction work. 94m. 05chs. and 94m.p. (86/17)
69 Diss	Down and Up	07 00 to 19 00. Earthwork. Crane and mechanical equipment in use. (85/27)
70 Diss and Audley End LC	Down and Up	Bridgework (No. 315). 95m. 29chs. (86/16)

SECTION B - TEMPORARY ENGINEERING WORKS - continued

<u>At or between</u>	<u>Lines affected</u>	<u>Remarks</u>
<u>LIVERPOOL STREET TO NORWICH - continued</u>		
UNTIL FURTHER NOTICE - continued		
71	Diss and Tivetshall LC	Down and Up 07 30 to 18 00. Demolition work 97m 50chs. Mechanical equipment in use. (86/12)
72	Gissing LC	Down and Up 08 00 to 16 00. Level crossing road repairs. 98m. 56chs. Mechanical equipment in use. (86/26)
73	Hales Street LC	Down and Up 08 00 to 16 00. Level crossing road repairs. 100m. 26chs. Mechanical equipment in use. (86/28)
74	Tivetshall LC	Down and Up 07 30 to 18 00. Demolition work and level crossing road repairs. (Tivetshall LC). 100 $\frac{1}{2}$ m.p. Mechanical equipment in use. (86/28)
75	Tivetshall LC and Swainsthorpe LC	Down and Up <u>Between Trains</u> 07 30 to 18 00. Bridgework (Nos. 328 and 331A) and demolition work. 103m. 13chs. and 104m. 59chs. Crane and mechanical equipment in use. (86/8)
76	Newton Flotman LC	Down and Up 08 00 to 16 00. Level crossing road repairs. 108m. 17chs. Mechanical equipment in use. (86/26)
77	Swainsthorpe LC	Down and Up <u>Between Trains</u> 07 30 to 18 00. Level crossing road repairs and demolition work. 109m. 52chs. and 109 $\frac{3}{4}$ m.p. Mechanical equipment in use. (86/30)
78	Swainsthorpe LC and Trowse Lower Jn.	Down and Up 07 00 to 16 00. Bridgework (No. 346). 110m. 62chs. Mechanical equipment in use. (86/25)

SECTION B - TEMPORARY ENGINEERING WORKS - continued

At or between	Lines affected	Remarks
<u>LIVERPOOL STREET TO NORWICH - continued</u>		
UNTIL FURTHER NOTICE - continued		
79 Trowse Lower Jn and Norwich Station	All <u>Between Trains</u>	07 00 to 17 00. Construction work (overhead line), earthwork, track maintenance and signalling work. Points and signals disconnected. (86/7)
80 Trowse Swing Bridge	Down and Up <u>Between Trains</u>	Bridgework (No. 356). 123m. 36chs. Crane and mechanical equipment in use. (85/33)
81 Trowse Swing Bridge and Thorpe Jn	Down and Up <u>Between Trains</u>	07 30 to 18 00. Construction work. 123 $\frac{1}{2}$ m.p. Crane and mechanical equipment in use. (86/3)
82 Norwich Station	All	Track renewal, platform work and earthwork. Crane and mechanical equipment in use. (85/62)

FRIDAY 14 TO MONDAY 17 NOVEMBER

83 Bethnal Green and Bow Jn	Down and Up Main <u>BLOCKED</u>	23 00 Fri to 05 00 Mon. Bridgework (No. 36) and overhead line work. Mechanical equipment in use. <u>Isolation of electrical sections 311B, 312B. 23 00 Fri to 12 00 Sat</u> <u>Trains to travel over Electric lines. 12 00 to 23 15 Sat, 02 15 to 04 15 Sun, and 13 30 Sun to 04 00</u> <u>Mon. Diesel trains to/from Stratford direction to travel over Up Electric (between Bow Jn and Wheler Street Jn)/Up Main (between Wheler Street Jn and Liverpool Street) line under single line working. Trains to/from Hackney Downs direction to travel over Suburban lines between Liverpool Street and Bethnal Green (Country End). 04 00 to 05 00 Mon Trains to travel over Electric lines.</u>
-----------------------------	---------------------------------	--

SECTION B - TEMPORARY ENGINEERING WORKS - continued

At or between	Lines affected	Remarks
<u>LIVERPOOL STREET TO NORWICH - continued</u>		
<u>FRIDAY 14 TO MONDAY 17 NOVEMBER - continued</u>		
84 Bethnal Green and Bow Jn	Down Electric Up Electric Down Electric BLOCKED	23 00 Fri to 12 00 Sat) 23 00 Fri to 04 00 Mon) 12 00 Sat to 04 00 Mon) 12 00 Sat to 04 00 Mon)
Bethnal Green and Stratford (London End)	Down and Up Electric BLOCKED to electric trains	12 00 Sat to 04 00 Mon) 12 00 Sat to 23 15 Sat, 02 15 to 04 15 Sun, and 13 30 Sun to 04 00 Mon. Diesel trains to/from Stratford direction to travel over Up Electric (between Bow Jn and Wheler Street Jn)/Up Main (between Wheler Street Jn and Liverpool Street) line under single line working. Trains to/from Hackney Downs direction to travel over Suburban lines between Liverpool Street and Bethnal Green (Country End).

SECTION B - TEMPORARY ENGINEERING WORKS - continued

<u>At or between</u>	<u>Lines affected</u>	<u>Remarks</u>
<u>LIVERPOOL STREET TO NORWICH - continued</u>		
SATURDAY 15 NOVEMBER		
85 Liverpool Street Station	Platforms 8, 9 and 10 BLOCKED Platform 7 and London End Entry/Exit to/from Locomotive Holding Sidings BLOCKED to electric trains	05 00 to 12 30. Repairs to station roof and construction work. Mechanical equipment in use. <u>Isolation of electrical sections 305CEFGH. Trains to be replatformed as necessary.</u>
86 Liverpool Street Station	Platforms 14 and 15 BLOCKED	12 00 to 23 00. Construction work. Mechanical equipment in use. <u>Trains to be replatformed as necessary.</u>
87 Liverpool Street Station	Platforms 11 to 18 inc. BLOCKED to electric trains	12 00 to 23 15. In connection with engineering work. <u>Isolation of electrical sections 301BCDE, 302ABCD, 304ABCDEF. 12 00 to 23 00. Diesel trains to travel to/from Platform 11. Electric trains to be replatformed as necessary.</u>
88 Shenfield and Ingatestone	Down and Up Main	01 00 to 05 30. Signalling work. Signals disconnected.
SATURDAY/SUNDAY 15/16 NOVEMBER		
89 Gidea Park Jn and Shenfield (London End Jn)	Down and Up Main BLOCKED Down and Up Electric	23 59 to 18 00. Drainage, track maintenance, overhead line work and unloading materials. Mechanical equipment in use. <u>Isolation of electrical sections 331D, 332A. Trains to travel over Electric lines.</u>
90 Halifax Jn and East Suffolk Jn	All BLOCKED	23 45 to 07 30. Track maintenance and earthwork. Mechanical equipment in use. <u>Possession to be given up for passage of trains.</u>

SECTION B - TEMPORARY ENGINEERING WORKS - continued

At or between	Lines affected	Remarks
<u>LIVERPOOL STREET TO NORWICH - continued</u>		
SATURDAY/SUNDAY 15/16 NOVEMBER - continued		
91 East Suffolk Jn and Stowmarket	Down and Up Main BLOCKED	23 35 to 07 30. Track maintenance and bridgework (No. 255). Crane and mechanical equipment in use. <u>Possession to be given up for passage of 2Y22 23 20 Stratford to Stowmarket and 1Y02 02 20 Liverpool Street to Stowmarket over Down Main line and 5Y17 01 10 Stowmarket to Ipswich and 5Y15 04 55 Stowmarket to Ipswich over Up Main line.</u>
92 Haughley Jn and Diss	Up BLOCKED Down BLOCKED	22 00 to 15 30) Track maintenance,) track renewal, loading 23 30 to 07 15) rails and formation) renewal. Crane and) mechanical equipment) in use. <u>07 15 to</u>) <u>15 30 Sun Single</u>) <u>line working</u>) <u>over Down line.</u>
93 Diss and Flordon	Down BLOCKED	23 55 to 07 00. Loading materials.
94 Flordon and Trowse Lower Jn	Up BLOCKED Down BLOCKED	22 00 to 06 45) Track maintenance and) track renewal. Crane 23 55 to 10 00) and mechanical) equipment in use.
95 Trowse Swing Bridge and Norwich Station	'C' line/Up Main BLOCKED Down Main/'W' line BLOCKED	23 00 to 06 45) Construction work) (overhead line). 23 59 to 07 00) <u>Possession to be</u>) <u>given up for passage</u>) <u>of 1P04 02 10</u>) <u>Liverpool Street to</u>) <u>Yarmouth.</u>
96 Norwich and Whitlingham Jn	'A' and 'E' lines/Down and Up Lowestoft/ Main BLOCKED) 23 15 to 07 00. Construction work) (overhead line). <u>Possession to be</u>) <u>given up for passage of trains.</u>)))
Norwich Station	Platforms 4, 5 and 6 BLOCKED))))

SECTION B - TEMPORARY ENGINEERING WORKS - continued

At or between	Lines affected		Remarks
<u>LIVERPOOL STREET TO NORWICH - continued</u>			
<u>SATURDAY/SUNDAY 15/16 AND SUNDAY 16 NOVEMBER</u>			
97	Liverpool Street and Bethnal Green	Down and Up Suburban BLOCKED to electric trains	23 15 Sat to 13 30) Repairs to station roof, construction work, demolition work and track maintenance.
	Liverpool Street Station	Platforms 9 and 10 BLOCKED to electric trains	23 15 Sat to 04 15) Mechanical equipment in use. Isolation of electrical sections 305 and 306.
		Platforms 1 to 8 inc. (and approaches) BLOCKED	23 15 Sat to 13 30) Electric trains to travel over Main or Electric lines. Trains to be replatformed as necessary.
		Locomotive Holding Sidings BLOCKED to electric trains	23 15 Sat to 13 30))))
		Platforms 9 and 10 BLOCKED	04 15 to 13 30 Sun)))
98	Church Lane LC and New Hall G.F.	Up Main BLOCKED Down Main BLOCKED Down Main	23 25 Sat to 13 45) Track maintenance, repairs to platform awnings (Chelmsford Station) and overhead line work. Mechanical equipment in use. Possession to be given up for passage of LY02 02 20 Liverpool Street to Stowmarket over Up Main line under single line working.

SECTION B - TEMPORARY ENGINEERING WORKS - continued

At or between	Lines affected	Remarks
<u>LIVERPOOL STREET TO NORWICH - continued</u>		
SATURDAY/SUNDAY 15/16 AND SUNDAY 16 NOVEMBER - continued		
99 New Hall G.F. and Witham	Up BLOCKED Down BLOCKED	23 15 Sat to 15 15)Track maintenance,)track renewal, 00 10 to 13 30 Sun)formation renewal,)drainage and)overhead line work.)Crane and)mechanical)equipment in use.)00 10 to 13 30 Sun.) <u>Possession to be</u>) <u>given up for 1Y02</u>) <u>02 20 Liverpool</u>) <u>Street to</u>) <u>Stowmarket</u>) <u>over Down line.</u>) <u>13 30 to 15 15</u>) <u>Sun Single line</u>) <u>working over</u>) <u>Down line.</u>
100 Marks Tey Station and Colchester	Up Main BLOCKED Down Main BLOCKED	23 30 Sat to 06 15)Loading materials)46 $\frac{1}{2}$ m.p. and 50m 00 25 to 07 00 Sun)70chs. Mechanical)equipment in use.) <u>Possession to be</u>) <u>given up for</u>) <u>passage of 1Y02</u>) <u>02 20 Liverpool</u>) <u>Street to</u>) <u>Stowmarket over</u>) <u>Down Main line and</u>) <u>Engineers' trains.</u>
SUNDAY 16 NOVEMBER		
101 Gidea Park	Down and Up Electric	08 00 to 16 00. Signalling work (No. 40B points).
102 Shenfield and Witham	All BLOCKED to electric trains	00 10 to 13 30. In connection with engineering work. <u>Isolation of</u> <u>electrical sections 333, 334, 335 and</u> <u>336.</u>

SECTION B - TEMPORARY ENGINEERING WORKS - continued

At or between	Lines affected	Remarks
---------------	----------------	---------

LIVERPOOL STREET TO NORWICH - continued

SUNDAY 16 NOVEMBER - continued

103	East Suffolk Jn and Haughley Jn	All BLOCKED to electric trains	01 40 to 07 30. In connection with engineering work between East Suffolk Jn and Stowmarket. <u>Isolation of electrical sections 345 and 346.</u>
104	Haughley Jn	All	08 00 to 16 00. Signalling work.
105	Trowse Swing Bridge and Norwich Station	All	07 00 to 18 00. Signalling work. Points and signals disconnected.

SUNDAY/MONDAY 16/17 NOVEMBER

106	Liverpool Street Station	Platforms 11 to 18 inc. BLOCKED to electric trains	13 30 to 02 30. In connection with engineering work. <u>Isolation of electrical sections 301BCDE, 302ABCD, 304ABCDEF.</u> 14 30 to 23 59 Sun Diesel trains to travel to/from Platform 11. <u>Electric trains to be replatformed as necessary.</u>
107	Liverpool Street Station	Platforms 17 and 18 (and approaches) BLOCKED	13 30 to 05 45. Earthwork and construction work. Mechanical equipment in use. <u>Trains to be replatformed as necessary.</u>
108	Liverpool Street Station	Platforms 14 and 15 BLOCKED	14 30 to 02 00. Construction work. Mechanical equipment in use. <u>Trains to be replatformed as necessary.</u>

SUNDAY 16 TO FRIDAY 21 NOVEMBER

109	Norwich and Whitlingham Jn	'A' and 'E' lines/Down and Up Lowestoft/Main BLOCKED)23 30 Sun to Thu to 05 00 Mon to Fri.)Construction work (overhead line) and)track maintenance. Crane in use.) <u>Possession to be given up for passage of trains.</u>)
	Norwich Station	Platforms 4, 5 and 6 BLOCKED)))

SECTION B - TEMPORARY ENGINEERING WORKS - continued

<u>At or between</u>	<u>Lines affected</u>	<u>Remarks</u>
<u>LIVERPOOL STREET TO NORWICH - continued</u>		
MONDAY 17 NOVEMBER		
110 Shenfield and Church Lane LC	Down and Up Main BLOCKED	01 55 to 05 10. Overhead line work. <u>Isolation of electrical sections 331A, 332D, 333 and 334. Possession to be given up for passage of Diesel trains.</u>
111 Hill House G.F. and Manningtree North Jn	All BLOCKED to electric trains	01 40 to 04 00. In connection with overhead line work between Colchester and Ardleigh LC. <u>Isolation of electrical sections 339, 340, 341 and 342.</u>
112 Colchester and Ardleigh LC	Down and Up Main BLOCKED	01 40 to 04 00. Overhead line work. <u>Possession to be given up for passage of Diesel trains.</u>
MONDAY 17 TO WEDNESDAY 19 NOVEMBER		
113 Colchester and Ardleigh LC	Down Main BLOCKED	23 30 Mon and Tue to 05 00 Tue and Wed. Track maintenance. Mechanical equipment in use. <u>Single line working over Up Main line.</u>
MONDAY 17 TO FRIDAY 21 NOVEMBER		
114 Liverpool Street Station	Platform 10 BLOCKED	10 40 to 15 40 daily. Construction work. Mechanical equipment in use. <u>Isolation of electrical sections 305H. Trains to be replatformed as necessary.</u>
115 Liverpool Street Station	Platforms 14 and 15 BLOCKED	23 50 Mon to Thu to 05 00 Tue to Fri. Construction work. Mechanical equipment in use. <u>Isolation of electrical sections 302A, 304D. Trains to be replatformed as necessary.</u>
116 Diss and Haughley Jn	Up BLOCKED	22 00 Mon to Thu to 05 00 Tue to Fri. Track maintenance and track renewal. Mechanical equipment in use. <u>Possession to be given up for passage of 1C03 23 35 Norwich to Liverpool Street.</u>

SECTION B - TEMPORARY ENGINEERING WORKS - continued

At or between	Lines affected	Remarks
---------------	----------------	---------

LIVERPOOL STREET TO NORWICH - continued

MONDAY 17 TO SATURDAY 22 NOVEMBER

117	Gidea Park Jn and Shenfield (London End Jn)	Down and Up Main BLOCKED	21 15 Mon to Fri to 05 00 Tue to Sat. Track maintenance, unloading materials, undertrack excavation and overhead line work. Mechanical equipment in use. <u>Isolation of electrical sections 331D, 332A.</u> <u>Trains to travel over Electric lines.</u>
-----	---	--------------------------------	--

TUESDAY 18 AND WEDNESDAY 19 NOVEMBER

118	Chelmsford and Church Lane LC	Up BLOCKED	00 10 to 05 00 daily. Track maintenance. 29% and 29% m.p. <u>Single line working over Down line.</u>
-----	-------------------------------------	---------------	--

FRIDAY 21 TO MONDAY 24 NOVEMBER

119	Bethnal Green and Bow Jn	Down and Up Main BLOCKED	23 00 Fri to 05 00 Mon. Bridgework (No. 36) and overhead line work. Mechanical equipment in use. <u>Isolation of electrical sections 311B, 312B. 23 00 Fri to 12 00 Sat</u> <u>Trains to travel over Electric</u> <u>lines. 12 00 to 23 15 Sat, 02 15 to</u> <u>04 15 Sun, and 13 30 Sun to 04 00</u> <u>Mon. Diesel trains to/from Stratford</u> <u>direction to travel over Up Electric</u> <u>(between Bow Jn and Wheler Street</u> <u>Jn)/Up Main (between Wheler Street Jn</u> <u>and Liverpool Street) line under</u> <u>single line working. Trains to/from</u> <u>Hackney Downs direction to travel</u> <u>over Suburban lines between Liverpool</u> <u>Street and Bethnal Green (Country</u> <u>End). 04 00 to 05 00 Mon Trains to</u> <u>travel over Electric lines.</u>
-----	-----------------------------	-----------------------------	---

SECTION B - TEMPORARY ENGINEERING WORKS - continued

<u>At or between</u>	<u>Lines affected</u>	<u>Remarks</u>
----------------------	-----------------------	----------------

LIVERPOOL STREET TO NORWICH - continued

FRIDAY 21 TO MONDAY 24 NOVEMBER - continued

120	Bethnal Green and Bow Jn	Down Electric	23 00 Fri to 12 00 Sat)	Bridgework (No. 36) and
		Up Electric	23 00 Fri to 04 00 Mon)	overhead line work.
		Down Electric BLOCKED	12 00 Sat to 04 00 Mon)	Mechanical equipment in use. 12 00 Sat
	Bethnal Green and Stratford (London End)	Down and Up Electric BLOCKED to electric trains	12 00 Sat to 04 00 Mon)	to 04 00 Mon Isolation of electrical sections 309A, 310B. 12 00 to 23 15 Sat, 02 15 to 04 15 Sun, and 13 30 Sun to 04 00 Mon.

Diesel trains to/from Stratford direction to travel over Up Electric (between Bow Jn and Wheler Street Jn)/Up Main (between Wheler Street Jn and Liverpool Street) line under single line working. Trains to/from Hackney Downs direction to travel over Suburban lines between Liverpool Street and Bethnal Green (Country End).

NAVARINO ROAD JN TO NORTH WOOLWICH

UNTIL FURTHER NOTICE

121	Highbury and Homerton	All	07 30 to 18 00. Earthwork and construction work. Mechanical equipment in use.
-----	-----------------------	-----	---

(86/1)

SUNDAY 16 NOVEMBER

122	Dalston Western Jn and Hackney Central	All BLOCKED to AC electric trains	00 01 to 08 00. In connection with engineering work between Dalston Western Jn and Lea Jn. <u>Isolation of electrical sections 314DEF.</u>
-----	--	---	--

SECTION B - TEMPORARY ENGINEERING WORKS - continued

At or between	Lines affected	Remarks
---------------	----------------	---------

NAVARINO ROAD JN TO NORTH WOOLWICH - continued

SUNDAY 16 NOVEMBER - continued

123	Dalston Western Jn and Lea Jn	All BLOCKED	00 01 to 08 00. Track maintenance and demolition work. <u>Isolation of DC electrical sections 707, 708, 709B, 710A.</u>
124	Channelsea South Jn and North Woolwich	All BLOCKED	00 15 to 07 30. Tunnelwork (Stratford Low Level Tunnel) and bridgework (Nos. 618A and 619). <u>Isolation of electrical sections 701, 702, 703, 704, 705AB, 706BC.</u>

CHANNELSEA SOUTH JN TO STRATFORD CENTRAL JN WEST

UNTIL FURTHER NOTICE

125	Channelsea South Jn and Stratford Central Jn West	Down and Up BLOCKED to electric trains	In connection with engineering work. (86/14)
-----	---	--	--

FOREST GATE JN TO WOODGRANGE PARK JN

SUNDAY 16 NOVEMBER

126	Forest Gate Jn and Barking Station (Country End)	All BLOCKED to electric trains	00 50 to 06 15. In connection with engineering work between Woodgrange Park Jn and Barking Tilbury Line Jn West. <u>Isolation of electrical sections 512 and 513.</u>
-----	--	--------------------------------------	---

ROMFORD TO UPMINSTER

SUNDAY 16 NOVEMBER

127	Romford and Upminster	Single BLOCKED	08 00 to 13 00. Track maintenance. Mechanical equipment in use.
-----	-----------------------	-------------------	---

SECTION B - TEMPORARY ENGINEERING WORKS - continued

<u>At or between</u>	<u>Lines affected</u>	<u>Remarks</u>
<u>SHENFIELD JN TO SOUTHEND VICTORIA</u>		
UNTIL FURTHER NOTICE		
128 Billericay	Down and Up	07 30 to 17 30. Construction work and platform work. Mechanical equipment in use. (86/19)
129 Wickford Station	All	Platform work and earthwork. (85/63)
130 Wickford Jn	All	08 00 to 17 00. Signalling work. (85/41)
131 Rayleigh and Hockley	Down	08 00 to 17 00. Earthwork 34½ and 34¾ m.p. Mechanical equipment in use. (85/61)
132 Southend Victoria Station	All	08 00 to 18 00. Repairs to station roof. (86/20)
SATURDAY 15 NOVEMBER		
133 Shenfield Jn and Wickford Station	All BLOCKED to electric trains	00 35 to 04 10. In connection with overhead line work between Mountnessing Jn and Wickford Station. <u>Isolation of electrical sections 371 and 372.</u>
134 Mountnessing Jn and Wickford Station (Country End)	Down and Up BLOCKED	00 35 to 04 10. Overhead line work. Mechanical equipment in use.
<u>WICKFORD JN TO SOUTHMINSTER</u>		
UNTIL FURTHER NOTICE		
135 Wickford Jn	All	08 00 to 17 00. Signalling work. (85/41)
136 Fambridge Station	Single	07 30 to 18 00. Platform work. (85/55)
137 Burnham-on-Crouch	Single	07 30 to 18 00. Earthwork. 43m 24chs. (85/30)

SECTION B - TEMPORARY ENGINEERING WORKS - continued

At or between	Lines affected	Remarks
---------------	----------------	---------

WICKFORD JN TO SOUTHMINSTER - continued

SATURDAY 15 NOVEMBER

138 Wickford Jn and Southminster	Single BLOCKED	00 01 to 04 45. Unloading materials.
--	-------------------	--------------------------------------

WITHAM TO BRAINTREE

UNTIL FURTHER NOTICE

139 Witham and Braintree	Single	07 00 to 18 00. Construction work (Bridge No. 2102B). (86/19)
-----------------------------	--------	---

FRIDAY/SATURDAY 14/15 NOVEMBER

140 Witham and Braintree	Single BLOCKED	23 40 to 05 30. Bridgework (No.2102B) and overhead line work. Mechanical equipment in use. <u>Isolation of electrical sections 379.</u>
-----------------------------	-------------------	---

SUNDAY 16 NOVEMBER

141 Witham and Braintree	Single BLOCKED	00 10 to 08 45. Bridgework (No.2102B), loading materials and overhead line work. Mechanical equipment in use. <u>Isolation of electrical sections 379.</u>
-----------------------------	-------------------	---

MONDAY 17 TO SATURDAY 22 NOVEMBER

142 Witham and Braintree	Single BLOCKED	23 40 Mon to Fri to 05 30 Tue to Sat. Bridgework (No.2102B). Mechanical equipment in use. <u>Isolation of electrical sections 379.</u>
-----------------------------	-------------------	--

COLCHESTER TO CLACTON

UNTIL FURTHER NOTICE

143 Colchester Jn and East Gate Jn	Down Clacton Avoiding	08 00 to 17 00. Earthwork. 52m. 25chs. and 52m. 29chs. Mechanical equipment in use.
--	--------------------------	---

(85/38)

SECTION B - TEMPORARY ENGINEERING WORKS - continued

At or between	Lines affected	Remarks
<u>COLCHESTER TO CLACTON - continued</u>		
SUNDAY 16 NOVEMBER		
144 Colchester Jn and Clacton	All BLOCKED to electric trains	00 20 to 07 00. In connection with engineering work between East Gate Jn and Thorpe-le-Soken. <u>Isolation of electrical sections 381, 382, 383, 384, 385 and 386.</u>
145 East Gate Jn and Thorpe-le-Soken	Down and Up BLOCKED	00 10 to 07 30. Trimming lineside vegetation and loading and unloading materials. Mechanical equipment in use.
146 Clacton Station	All BLOCKED	00 20 to 07 00. Track renewal and unloading rails and materials. Mechanical equipment in use.
MONDAY 17 TO WEDNESDAY 19 NOVEMBER		
147 East Gate Jn and Thorpe-le-Soken	Down BLOCKED to electric trains	23 40 Mon and Tue to 04 45 Tue and Wed. In connection with engineering work. <u>Isolation of electrical sections 382C, 384AB.</u>
MONDAY 17 TO FRIDAY 21 NOVEMBER		
148 East Gate Jn and Thorpe-le-Soken	Down and Up BLOCKED	23 40 Mon to Thu to 04 45 Tue to Fri. Track maintenance, trimming lineside vegetation and loading rails. Mechanical equipment in use. <u>Possession to be given up for passage of Freight trains to/from Hythe.</u>
WEDNESDAY 19 TO FRIDAY 21 NOVEMBER		
149 Thorpe-le-Soken Jn and East Gate Jn	Up BLOCKED to electric trains	23 40 Wed and Thu to 04 45 Thu and Fri. In connection with engineering work. <u>Isolation of electrical sections 381A, 383CD.</u>

SECTION B - TEMPORARY ENGINEERING WORKS - continued

At or between	Lines affected	Remarks
---------------	-------------------	---------

EAST GATE JN TO ST BOTOLPHS

SUNDAY 16 NOVEMBER

150 East Gate Jn and St Botolphs	All BLOCKED to electric trains	00 20 to 07 00. In connection with engineering work between East Gate Jn and Thorpe-le-Soken. <u>Isolation of electrical sections 381.</u>
--	--------------------------------------	--

COLNE JN TO HYTHE JN

SUNDAY 16 NOVEMBER

151 Colne Jn and Hythe Jn	Down and Up BLOCKED to electric trains	00 20 to 07 00. In connection with engineering work between East Gate Jn and Thorpe-le-Soken. <u>Isolation of electrical sections 381.</u>
------------------------------	--	--

THORPE-LE-SOKEN TO WALTON-ON-NAZE

SUNDAY 16 NOVEMBER

152 Thorpe-le-Soken and Walton-on-Naze	Single BLOCKED to electric trains	00 20 to 07 00. In connection with engineering work between East Gate Jn and Thorpe-le-Soken. <u>Isolation of electrical sections 387.</u>
--	---	--

MANNINGTREE SOUTH JN TO HARWICH

UNTIL FURTHER NOTICE

153 Wrabness and Mistley	Up	07 30 to 17 00. Earthwork. 64m. 46chs. and 64m. 15chs. Mechanical equipment in use. (85/65)
154 Parkeston West and Harwich Town	Single	07 30 to 18 00. Track maintenance, track renewal and earthwork. 70 $\frac{1}{2}$ m.p. Mechanical equipment in use. (85/27)

SECTION B - TEMPORARY ENGINEERING WORKS - continued

<u>At or between</u>	<u>Lines affected</u>	<u>Remarks</u>
<u>WESTERFIELD JN TO FELIXSTOWE</u>		
UNTIL FURTHER NOTICE		
160 Westerfield Jn and Derby Road	Single	08 00 to 16 00. Earthwork. 73m. 13chs. and 7 $\frac{1}{2}$ m.p. (85/61)
161 Derby Road and Felixstowe Beach Jn	Single	07 30 to 17 00. Earthwork. 82% and 83m.p. Mechanical equipment in use. (86/1)
SATURDAY 15 TO MONDAY 17 NOVEMBER		
162 Derby Road and Felixstowe Beach Jn	Single BLOCKED	22 00 Sat to 05 00 Mon. Track maintenance, track renewal and reballasting. Crane and mechanical equipment in use.
<u>NORWICH TO LOWESTOFT</u>		
UNTIL FURTHER NOTICE		
163 Norwich Station	All	Track renewal, platform work and earthwork. Crane and mechanical equipment in use. (85/62)
164 Norwich Station and Trowse Lower Jn	All <u>Between Trains</u>	07 00 to 17 00. Construction work (overhead line), earthwork, track maintenance and signalling work. Points and signals disconnected. (86/7)
165 Thorpe Jn	All	08 00 to 17 00. Earthwork and track maintenance. (85/22)
166 Whitlingham Jn and Thorpe Jn	Up	07 30 to 17 00. Earthwork 1% and 1m.p. Mechanical equipment in use. (86/13)
167 Oulton Broad North Jn and Lowestoft	All	08 00 to 16 00. Undertrack excavation. 23 and 23 $\frac{1}{2}$ m.p. (86/26)

SECTION B - TEMPORARY ENGINEERING WORKS - continued

At or between	Lines affected	Remarks
<u>NORWICH TO LOWESTOFT - continued</u>		
SATURDAY/SUNDAY 15/16 NOVEMBER		
168	Trowse Swing Bridge and Norwich Station	'C' line/Up Main BLOCKED Down Main/'W' line BLOCKED
		23 00 to 06 45)Construction work) (overhead line). 23 59 to 07 00) <u>Possession to be given) up for passage of 1P04) 02 10 Liverpool Street) to Yarmouth.</u>
169	Norwich and Whitlingham Jn	'A' and 'E' lines/ Down and Up Lowestoft/Main BLOCKED
	Norwich Station	Platforms 4, 5 and 6 BLOCKED
)23 15 to 07 00. Construction work) (overhead line). <u>Possession to be) given up for passage of trains.</u>))))
170	Whitlingham Jn and Cantley	Up BLOCKED Down BLOCKED
		23 30 to 08 00)Track maintenance,) track renewal, 23 30 to 16 00)earthwork and) level crossing road) repairs (Brundall LC).) Crane and mechanical) equipment in use.) <u>23 30 Sat to 08 00</u>) <u>Possession to be given</u>) <u>up for passage of 1P04</u>) <u>02 10 Liverpool Street</u>) <u>to Yarmouth and 1B02</u>) <u>05 39 Norwich to</u>) <u>Lowestoft over Up line</u>) <u>under single line</u>) <u>working. 08 00 to 16 00</u>) <u>Sun Single line working</u>) <u>over Up line.</u>
SUNDAY 16 NOVEMBER		
171	Trowse Swing Bridge and Norwich Station	All
		07 00 to 18 00. Signalling work. Points and signals disconnected

SECTION B - TEMPORARY ENGINEERING WORKS - continued

At or between	Lines affected	Remarks
---------------	----------------	---------

NORWICH TO LOWESTOFT - continued

SUNDAY 16 TO FRIDAY 21 NOVEMBER

172	Norwich and Whitlingham Jn	'A' and 'E' lines/Down and Up Lowestoft/ Main BLOCKED)23 30 Sun to Thu to 05 00 Mon to Fri.)Construction work (overhead line) and)loading rails. Crane in use.) <u>Possession to be given up for</u>) <u>passage of trains.</u>))))
	Norwich Station	Platforms 4, 5 and 6 BLOCKED))))

WHITLINGHAM JN TO CROMER

UNTIL FURTHER NOTICE

173	Whitlingham Jn and Wroxham	Down and Up	07 30 to 16 30. Bridgework (No. 365). 3m. 48chs. (86/6)
174	Cromer Station	Platforms 1 and 2	Platform work. (86/15)

CROMER TO SHERINGHAM

UNTIL FURTHER NOTICE

175	Cromer Station	Platforms 1 and 2	Platform work. (86/15)
-----	----------------	----------------------	-------------------------------

BRUNDALL JN TO YARMOUTH VIA ACLE

UNTIL FURTHER NOTICE

176	Lingwood	Single	08 00 to 17 00. Construction work. 8m. 03chs. (86/12)
177	Brundall Jn and Yarmouth	All	08 00 to 16 00. Signalling work. (86/30)

SECTION B - TEMPORARY ENGINEERING WORKS - continued

At or between	Lines affected	Remarks
<u>REEDHAM JN TO YARMOUTH</u>		
UNTIL FURTHER NOTICE		
178	Reedham Jn and Yarmouth	All 08 00 to 16 00. Signalling work. (86/30)
<u>BETHNAL GREEN JN TO KING'S LYNN</u>		
UNTIL FURTHER NOTICE		
179	Cambridge Heath Station	Down and Up Suburban 08 00 to 17 00. Platform work. 1m. 6lchs. Mechanical equipment in use. (<u>See Section 'D'</u>). (86/24)
180	London Fields Station	Down and Up Suburban Platform work. 2m. 35chs. Mechanical equipment in use. (<u>See Section 'D'</u>). (86/27)
181	Enfield Lock Station	Up 08 00 to 16 30. Platform work. 11m. 65chs. Mechanical equipment in use. (86/28)
182	Enfield Lock and Waltham Cross	Down and Up 07 00 to 18 00. Bridgework (No.1418C). 12m. 34chs. Crane and mechanical equipment in use. (85/59)
183	Bishops Stortford (Country end) and Stansted	Down and Up Main BLOCKED to electric trains Overhead line work. <u>Isolation of electrical sections 427, 428 (buffer section)</u> . (85/41)
184	Bishops Stortford and Cambridge (North)	All 07 00 to 18 00. Construction work (overhead line). Mechanical equipment in use. (85/21)
185	Stansted and Chesterton Jn	All 08 00 to 18 00. Signalling work. <u>Until 18 00 Friday 21 November.</u> (86/33)
186	Whittlesford Station	Down and Up Platform work. 49m. 02chs. Mechanical equipment in use. (86/29)
187	Chesterton Jn and Milton Fen LC	Down and Up 07 30 to 18 00. Bridgework (No. 1550B). 58m. 63chs. Mechanical equipment in use. (86/24)

SECTION B - TEMPORARY ENGINEERING WORKS - continued

At or between	Lines affected	Remarks
---------------	----------------	---------

BETHNAL GREEN JN TO KING'S LYNN - continued

SATURDAY 15 NOVEMBER

188 Coldham Lane Jn and Waterbeach	All <u>Between Trains</u>	07 00 to 16 00. Bridgework (Nos.1547, 1548, 1548A, 1549 and 1550A).
--	------------------------------	--

SATURDAY/SUNDAY 15/16 NOVEMBER

189 Spelbrook and Harlow Mill	Up BLOCKED	23 30 to 06 00. Track maintenance. 28m 15chs and 26m 55chs.
190 Bishops Stortford and Audley End	Up Main BLOCKED Down Main BLOCKED	22 30 to 08 30)Construction work)overhead line) and 23 50 to 09 00)work on overhead power)cables (EEB). 30% and)4 1/2 m.p. Mechanical)equipment in use.)Possession to be)given up for passage)of <u>1P04 02 10 Liverpool</u>) <u>Street to Yarmouth and</u>) <u>1H02 03 10 Liverpool</u>) <u>Street to King's Lynn</u>) <u>over Down Main line.</u>

SUNDAY 16 NOVEMBER

191 Bethnal Green and Hackney Downs North Jn	Down and Up Fast BLOCKED	00 40 to 06 30. Track maintenance. <u>Trains to travel over Suburban lines.</u>
192 Clapton Jn and Cheshunt Jn	Down and Up Main BLOCKED to electric trains	00 01 to 22 00. In connection with engineering work between Tottenham South Jn and Cheshunt Jn. <u>Isolation</u> <u>of electrical sections 411 and 412.</u> <u>Electric trains diverted via</u> <u>Southbury.</u>
193 Tottenham South Jn and Cheshunt Jn	Down and Up Main BLOCKED	00 01 to 22 00. Track maintenance, formation renewal, bridgework (No. 1418C) and overhead line work. Crane and mechanical equipment in use. <u>Trains diverted via Southbury.</u>

SECTION B - TEMPORARY ENGINEERING WORKS - continued

At or between	Lines affected	Remarks
---------------	----------------	---------

BETHNAL GREEN JN TO KING'S LYNN - continued

SUNDAY 16 NOVEMBER - continued

194	Audley End and Great Chesterford	Down and Up BLOCKED	00 01 to 08 00. Trimming lineside vegetation. 42 and 43 $\frac{1}{2}$ m.p. Mechanical equipment in use. <u>Possession to be given up for passage of 1P04 02 10 Liverpool Street to Yarmouth and 1H02 03 10 Liverpool Street to King's Lynn over Down line.</u>
195	Shepreth Branch Jn and Coldham Lane Jn	All <u>Between Trains</u>	00 30 to 08 00. Construction work. (overhead line). 53 $\frac{1}{2}$ and 56 $\frac{1}{2}$ m.p. Mechanical equipment in use.
196	Waterbeach and Ely Dock Jn	Down and Up BLOCKED	00 35 to 08 00. Track maintenance. 61 and 69m.p. <u>Possession to be given up for passage of 1P04 02 10 Liverpool Street to Yarmouth and 1H02 03 10 Liverpool Street to King's Lynn over Down line.</u>
197	Ely North Jn and Littleport	Down and Up	07 00 to 16 00. Signalling work.

SUNDAY/MONDAY 16/17 NOVEMBER

198	Shepreth Branch Jn and Cambridge (South)	Down Main and Down Goods Loop South BLOCKED	23 00 to 05 30. Construction work (overhead line). 53 $\frac{1}{2}$ and 55 $\frac{1}{2}$ m.p. Mechanical equipment in use. <u>Single line working over Up Main line.</u>
199	Cambridge (South) and Coldham Lane Jn	All <u>Between trains</u>	23 00 to 05 30. Construction work (overhead line). 55 $\frac{1}{2}$ and 56 $\frac{1}{2}$ m.p. Mechanical equipment in use.

MONDAY 17 NOVEMBER

200	Cheshunt Jn (London End) and Bishops Stortford (Country End)	All BLOCKED to electric trains	00 40 to 03 50. In connection with overhead line work between Broxbourne Jn. and Harlow Town. <u>Isolation of electrical sections 413, 414, 415, 416, 417 and 418</u>
201	Broxbourne Jn and Harlow Town	Down and Up BLOCKED	00 40 to 03 50. Overhead line work. <u>Possession to be given up for passage of Diesel trains</u>

SECTION B - TEMPORARY ENGINEERING WORKS - continued

At or between	Lines affected	Remarks
BETHNAL GREEN JN TO KING'S LYNN - continued		
MONDAY 17 TO THURSDAY 20 NOVEMBER		
202 Bishops Stortford and Stansted	Down Main BLOCKED	09 15 to 15 00 daily. Construction work (overhead line) 30% and 33% <u>m.p.</u> <u>Single line working over Up Main line.</u>
203 Audley End and Great Chesterford	Down and Up <u>Between trains</u>	23 00 Mon to Wed to 06 00 Tue to Thu. Trimming lineside vegetation. 41% and 42% <u>m.p.</u>
MONDAY 17 TO FRIDAY 21 NOVEMBER		
204 Whittlesford Station and Shelford	Down and Up	08 00 to 16 00 daily. Trimming lineside vegetation. 49 and 52% <u>m.p.</u>
205 Shelford and Shepreth Branch Jn	Down	08 00 to 16 00 daily. Trimming lineside vegetation. 52% and 53 <u>m.p.</u> Mechanical equipment in use.
206 Shepreth Branch Jn and Coldham Lane Jn	All <u>Between Trains</u>	08 00 to 16 00 daily. Construction work (overhead line). 53% and 56% <u>m.p.</u> Mechanical equipment in use.
207 Shepreth Branch Jn and Coldham Lane Jn	All <u>Between Trains</u>	23 30 Mon to Thu to 06 00 Tue to Fri. Construction work (overhead line). 53% and 56% <u>m.p.</u> Mechanical equipment in use.
TUESDAY 18 TO FRIDAY 21 NOVEMBER		
208 Clapton Jn and Cheshunt Jn	Down and Up Main BLOCKED to electric trains	00 01 to 04 30 daily. In connection with engineering work between Brimsdown and Cheshunt Jn. <u>Isolation of electrical sections 411 and 412.</u> <u>Electric trains diverted via Southbury.</u>
209 Brimsdown and Cheshunt Jn	Down and Up BLOCKED	00 01 to 04 30 daily. Overhead line work and bridgework (No.1418C). Mechanical equipment in use. <u>Possession to be given up for passage of Diesel trains. Electric trains diverted via Southbury.</u>

SECTION B - TEMPORARY ENGINEERING WORKS - continued

At or between	Lines affected	Remarks
---------------	----------------	---------

BETHNAL GREEN JN TO KING'S LYNN - continued

WEDNESDAY 19 NOVEMBER

210	Tottenham Hale and Brimsdown	Down BLOCKED	00 01 to 05 45. Track maintenance. Mechanical equipment in use. <u>Single line working over Up line.</u>
-----	------------------------------	-----------------	--

WEDNESDAY/THURSDAY 19/20 NOVEMBER

211	Harlow Town and Harlow Mill	Down BLOCKED	23 15 to 04 20. Track maintenance. Mechanical equipment in use. <u>Single line working over Up line.</u>
-----	-----------------------------	-----------------	--

THURSDAY/FRIDAY 20/21 NOVEMBER

212	Harlow Mill and Harlow Town	Up BLOCKED	23 00 to 05 30. Track maintenance. Mechanical equipment in use. <u>Single line working over Down line.</u>
-----	-----------------------------	---------------	--

FRIDAY 21 NOVEMBER

213	Stansted and Bishops Stortford	Up Main BLOCKED	09 20 to 15 45. Construction work (overhead line). 33% and 30% m.p. <u>Single line working over Down Main line.</u>
-----	--------------------------------	--------------------	---

READING LANE JN TO NAVARINO ROAD JN (GRAHAM ROAD CURVE)

SUNDAY 16 NOVEMBER

214	Reading Lane Jn and Navarino Road Jn	Single BLOCKED to electric trains	00 01 to 08 00. In connection with engineering work between Dalston Western Jn and Lea Jn. <u>Isolation of electrical sections 314C.</u>
-----	--------------------------------------	--------------------------------------	--

CLAPTON JN TO CHINGFORD

SATURDAY 15 NOVEMBER

215	Clapton Jn and Chingford	Down and Up BLOCKED	00 25 to 04 00. Overhead line work. Mechanical equipment in use. <u>Isolation of electrical sections 409 and 410.</u>
-----	--------------------------	------------------------	---

SECTION B - TEMPORARY ENGINEERING WORKS - continued

At or between	Lines affected	Remarks
---------------	----------------	---------

CLAPTON JN TO CHINGFORD - continued

TUESDAY 18 TO THURSDAY 20 NOVEMBER

216 Clapton Jn and Chingford	Down and Up BLOCKED	00 55 to 04 50 daily. Loading materials.
---------------------------------	------------------------	--

BROXBOURNE JN TO HERTFORD EAST

UNTIL FURTHER NOTICE

217 Rye House and St. Margarets	Down and Up	08 00 to 18 00. Bridgework (No. 2035A). 19m. 66chs. Mechanical equipment in use. (85/60)
------------------------------------	-------------	---

SUNDAY 16 NOVEMBER

218 Broxbourne Jn and Hertford East	All BLOCKED	00 30 to 06 30. Platform work and construction work (St. Margarets Station), track renewal and unloading rails and materials. Mechanical equipment in use.
---	----------------	--

MONDAY 17 NOVEMBER

219 Broxbourne Jn and St. Margarets	Down and Up BLOCKED to electric trains	00 40 to 03 50. In connection with overhead line work between Broxbourne Jn. and Harlow Town. <u>Isolation of electrical sections 414.</u>
---	--	--

TUESDAY 18 TO FRIDAY 21 NOVEMBER

220 Broxbourne Jn and Hertford East	All BLOCKED	00 35 to 04 50 daily. Platform work and construction work (St. Margarets Station). Mechanical equipment in use.
---	----------------	---

COLDHAM LANE JN TO HAUGHLEY JN

UNTIL FURTHER NOTICE

221 Bury St. Edmunds Station	Down	08 00 to 15 00. Repairs to platform awnings. (86/18)
---------------------------------	------	---

SECTION B - TEMPORARY ENGINEERING WORKS - continued

At or between	Lines affected	Remarks
---------------	----------------	---------

COLDHAM LANE JN TO HAUGHLEY JN - continued

UNTIL FURTHER NOTICE - continued

222	Bury St. Edmunds and Elmswell	Down and Up	08 00 to 18 00. Drainage. 29m. 78chs. Mechanical equipment in use. (86/12)
-----	-------------------------------------	-------------	--

SATURDAY/SUNDAY 15/16 NOVEMBER

223	Bury St. Edmunds and Haughley Jn.	Up BLOCKED Down BLOCKED	22 00 to 13 15)Track maintenance and)loading rails. Crane 23 15 to 13 15)and mechanical)equipment in use.
-----	---	----------------------------------	--

SUNDAY 16 NOVEMBER

224	Haughley Jn.	All	08 00 to 16 00. Signalling work.
-----	--------------	-----	----------------------------------

WEDNESDAY/THURSDAY 19/20 NOVEMBER

225	Bury St. Edmunds and Chippenham Jn.	Up BLOCKED	23 00 to 05 30. Track maintenance. Mechanical equipment in use. <u>Single line working over Down line.</u>
-----	---	---------------	--

THURSDAY/FRIDAY 20/21 NOVEMBER

226	Elmswell and Bury St. Edmunds	Down BLOCKED	23 00 to 05 30. Track maintenance. Mechanical equipment in use. <u>Single line working over Up line.</u>
-----	-------------------------------------	-----------------	---

ELY NORTH JN TO PETERBOROUGH, CRESCENT JN

SATURDAY 15 TO SUNDAY 16 NOVEMBER

227	Chettisham and Manea	Down BLOCKED Up BLOCKED	11 30 Sat to 18 00 Sun)Bridgework) (Nos. 1813 and 11 45 Sat to 14 00 Sun)1814) 78 and) 78 $\frac{3}{4}$ m.p. Crane) and mechanical) equipment in) use. <u>14 00</u>) <u>to 18 00 Sun.</u>) <u>Single line</u>) <u>working over</u>) <u>Up line.</u>
-----	-------------------------	----------------------------------	--

SECTION B - TEMPORARY ENGINEERING WORKS - continued

At or between	Lines affected	Remarks
---------------	----------------	---------

ELY NORTH JN TO PETERBOROUGH, CRESCENT JN - continued

SUNDAY 16 NOVEMBER

228	March West Jn. and Whittlesea	Down and Up Main BLOCKED	00 01 to 08 00. Loading materials. 92 and 94m.p. Mechanical equipment in use.
229	March West Jn and Three Horse Shoes	Down and Up Main	07 00 to 17 00. Signalling work.
230	Whittlesea and Peterborough (East)	Down and Up BLOCKED	00 01 to 08 00. Track maintenance. 94% and 100m.p.
231	Peterborough Station	Down Slow and Platforms 4 and 5 BLOCKED)00 05 to 07 45. Construction work)(overhead line). 76m. 25chs. and)76m. 47chs. (ECML Mileage), 100m.)37chs. and 100m. 66chs. (Branch)mileage). <u>Trains to travel over)other lines and to be replatformed)as necessary.</u>)
	Peterborough (East) and Crescent Jn	Down and Up BLOCKED	

THURSDAY/FRIDAY 20/21 NOVEMBER

232	Chettisham and Manea	Down BLOCKED	23 15 to 05 00. Bridgework (Nos. 1813 and 1814). 78 and 78 $\frac{1}{2}$ m.p. <u>Single line working over Up line.</u>
-----	----------------------	-----------------	--

ELY NORTH JN TO TROWSE LOWER JN

UNTIL FURTHER NOTICE

233	Thetford and Lakenheath	Up	08 00 to 16 00. Track maintenance. 87% and 85 $\frac{1}{2}$ m.p. (86/24)
234	Wymondham and Hethersett	Down and Up <u>Between Trains</u>	07 30 to 18 00. Bridgework, earthwork and construction work. 115m. 65chs. and 117m. 69chs. Cranes and mechanical equipment in use. (86/18)
235	Wymondham and Trowse Lower Jn	Down and Up	07 30 to 16 00. Signalling work. (85/24)

SECTION B - TEMPORARY ENGINEERING WORKS - continued

At or between	Lines affected	Remarks
---------------	----------------	---------

ELY NORTH JN TO TROWSE LOWER JN - continued

UNTIL FURTHER NOTICE - continued

236	Hethersett and Trowse Lower Jn	Down and Up	07 30 to 16 00. Bridgework (Nos.1638, 1640, 1640A and 349). 121m. 17chs. and 122m. 32chs.
			(86/22)

SATURDAY/SUNDAY 15/16 NOVEMBER

237	Hethersett and Trowse Lower Jn	Up BLOCKED Down BLOCKED	21 30 to 16 30)Bridgework (Nos. 1640 and 1640A). 121 ³ / ₄ m.p. 23 35 to 07 15)Crane and mechanical equipment in use.)23 35 Sat to 07 15.) <u>Possession to be given up for passage of 1P04</u>) <u>02 10 Liverpool Street to Yarmouth over Down line.</u> 07 15 to 16 30) <u>Sun. Single line working over Down line.</u>
-----	--------------------------------	----------------------------------	---

MONDAY 17 TO FRIDAY 21 NOVEMBER

238	Spooer Row and Wymondham	Down and Up BLOCKED	23 15 Mon to Thu to 06 30 Tue to Fri. Track maintenance. Mechanical equipment in use.
239	Hethersett and Trowse Lower Jn	Down and Up BLOCKED	23 00 Mon to Thu to 06 30 Tue to Fri. Track maintenance. Mechanical equipment in use.

WYMONDHAM TO NORTH ELMHAM

UNTIL FURTHER NOTICE

240	Wymondham and North Elmham	Single	08 00 to 16 00. Trimming lineside vegetation. $\frac{1}{2}$ and 6m.p. Mechanical equipment in use.
			(85/31)

SUNDAY 16 NOVEMBER

241	Wymondham and North Elmham	Single BLOCKED	07 00 to 16 30. Bridgework.
-----	----------------------------	-------------------	-----------------------------

SECTION B - TEMPORARY ENGINEERING WORKS - continued

<u>At or between</u>	<u>Lines affected</u>	<u>Remarks</u>
<u>WYMONDHAM TO NORTH ELMHAM - continued</u>		
MONDAY 17 TO FRIDAY 21 NOVEMBER		
242 Wymondham and North Elmham	Single	08 00 to 16 00 daily. Trimming lineside vegetation. 7% and 9½m.p. Mechanical equipment in use.
<u>FENCHURCH STREET TO SHOEBURYNESS</u>		
UNTIL FURTHER NOTICE		
243 Fenchurch Street Station	All	Construction/demolition work. Mechanical equipment in use. (84/38)
244 Fenchurch Street and Stepney East	All	Construction work, and in connection with engineering work (Docklands Light Railway). Mechanical equipment in use. <u>(See Section 'D')</u> . (86/25)
245 Fenchurch Street and Gas Factory Jn	All	08 00 to 17 00. Signalling work. (86/1)
246 East Ham	Down and Up	Construction work. Mechanical equipment in use. (83/51)
247 East Ham and Barking (London End)	Down and Up	Erecting scaffolding in connection with bridge No. 66B. (85/8)
248 Leigh-on-Sea and Benfleet	Up	Sea wall work. (85/34)
249 Leigh-on-Sea	Down	09 00 to 16 00. Demolition work. Mechanical equipment in use. (85/60)
250 Westcliff-on-Sea	Down	09 00 to 16 00. Demolition work. Mechanical equipment in use. (85/60)

SECTION B - TEMPORARY ENGINEERING WORKS - continued

At or between	Lines affected	Remarks
---------------	----------------	---------

FENCHURCH STREET TO SHOEBURYNESS - continued

FRIDAY/SATURDAY 14/15 NOVEMBER

251	Fenchurch Street Station	Platforms 1,2,3 and 4 BLOCKED	21 15 to 06 00. Construction work. Mechanical equipment in use.
252	Fenchurch Street and Gas Factory Jn	All BLOCKED	21 15 to 06 00. Repairs to platform awnings (Stepney East Station), construction work and painting Stepney East Station. <u>Isolation of electrical sections 501, 502, 503 and 504.</u>
253	Gas Factory Jn and East Ham (London End)	Down and Up BLOCKED	21 15 to 06 00. Track maintenance Mechanical equipment in use.

FRIDAY/SATURDAY 14/15 AND SATURDAY 15 NOVEMBER

254	Upminster and Pitsea	Up BLOCKED Down BLOCKED	23 45 Fri to 04 25)Overhead line work. Mechanical 01 15 to 04 25 Sat)equipment in use.) <u>Isolation of</u>) <u>electrical</u>) <u>sections 517 and</u>) <u>519. 23 45 Fri</u>) <u>to 01 15 Up</u>) <u>trains diverted</u>) <u>via Grays.</u>) <u>01 15 to 04 25</u>) <u>Sat. Isolation</u>) <u>of electrical</u>) <u>sections 518 and</u>) <u>520. Trains</u>) <u>diverted via</u>) <u>Grays.</u>
-----	----------------------	----------------------------------	--

SUNDAY 16 NOVEMBER

255	Gas Factory Jn and East Ham (London End)	Down and Up BLOCKED	01 00 to 22 00. Track renewal and track maintenance. Crane and mechanical equipment in use. <u>Isolation of electrical sections 505, 506, 507 and 508.</u>
-----	--	------------------------	---

SECTION B - TEMPORARY ENGINEERING WORKS - continued

At or between	Lines affected	Remarks
---------------	----------------	---------

FENCHURCH STREET TO SHOEBURYNESSE - continued

SUNDAY 16 NOVEMBER - continued

256 Forest Gate Jn and Barking Station (Country End)	All BLOCKED to electric trains	00 50 to 06 15. In connection with engineering work between Woodgrange Park Jn and Barking Tilbury Lane Jn West. <u>Isolation of electrical sections 512 and 513.</u>
257 Laindon and Upminster	Up BLOCKED	00 01 to 06 00. Track maintenance.

MONDAY 17 NOVEMBER

258 Upminster (Country End) and Barking	Up Main BLOCKED	00 05 to 04 00. Overhead line work. <u>Isolation of electrical sections 511A, 515. Up trains diverted via Grays.</u>
---	-----------------	--

MONDAY 17 TO WEDNESDAY 19 NOVEMBER

259 Fenchurch Street and Gas Factory Jn	All BLOCKED	21 15 Mon and Tue to 06 00 Tue and Wed. Repairs to platform awnings (Stepney East Station), construction work and painting Stepney East Station. <u>Isolation of electrical sections 501, 502, 503 and 504.</u>
---	-------------	---

MONDAY 17 TO THURSDAY 20 NOVEMBER

260 Gas Factory Jn and East Ham (London End)	Down and Up BLOCKED	21 15 Mon to Wed to 06 00 Tue to Thu. Track maintenance. Mechanical equipment in use.
--	---------------------	---

MONDAY 17 TO SATURDAY 22 NOVEMBER

261 Fenchurch Street Station	Platforms 1,2,3 and 4 BLOCKED	21 15 Mon to Fri to 06 00 Tue to Sat. Construction work. Mechanical equipment in use.
262 Upminster and Pitsea	Down and Up BLOCKED	23 50 Mon to Fri to 04 25 Tue to Sat. Overhead line work and track maintenance. Mechanical equipment in use. <u>Isolation of electrical sections 517, 518, 519 and 520. Trains diverted via Grays.</u>

SECTION B - TEMPORARY ENGINEERING WORKS - continued

At or between	Lines affected	Remarks
---------------	----------------	---------

FENCHURCH STREET TO SHOEBURYNESSE - continued

TUESDAY 18 AND WEDNESDAY 19 NOVEMBER

263	Laindon and Pitsea	Down and Up	11 00 to 14 00 daily. Unloading materials.
-----	--------------------	-------------	--

WEDNESDAY 19 TO FRIDAY 21 NOVEMBER

264	Shoeburyness	All BLOCKED	23 30 Wed and Thu to 04 30 Thu and Fri. Track maintenance. Mechanical equipment in use. <u>Possession to be given up for passage of trains.</u>
-----	--------------	----------------	---

FRIDAY/SATURDAY 21/22 NOVEMBER

265	Fenchurch Street and Gas Factory Jn	All BLOCKED	21 15 to 06 00. Repairs to platform awnings (Stepney East Station), construction work and painting Stepney East Station. <u>Isolation of electrical sections 501, 502, 503 and 504.</u>
-----	-------------------------------------	----------------	---

GAS FACTORY JN TO BOW JN

SUNDAY 16 NOVEMBER

266	Gas Factory Jn and Bow Jn	Single BLOCKED to electric trains	01 00 to 22 00. In connection with engineering work between Gas Factory Jn and East Ham. <u>Isolation of electrical sections 506A.</u>
-----	---------------------------	--------------------------------------	--

UPPER HOLLOWAY TO BARKING, TILBURY LINE JN WEST

UNTIL FURTHER NOTICE

267	Upper Holloway and Crouch Hill Station	Down and Up	Earthwork. 3m 41chs. and 3m 43chs. Mechanical equipment in use. (85/64)
-----	--	-------------	--

268	Wanstead Park Station	Up	08 00 to 16 00. Platform work. <u>(See Section 'D')</u> . (85/50)
-----	-----------------------	----	--

SECTION B - TEMPORARY ENGINEERING WORKS - continued

<u>At or between</u>	<u>Lines</u>	<u>Remarks</u>
	<u>affected</u>	

UPPER HOLLOWAY TO BARKING, TILBURY LINE JN WEST - continued

UNTIL FURTHER NOTICE - continued

269	Woodgrange Park and Barking Station Jn	Down and Up <u>Between Trains</u>	07 30 to 18 00. Bridgework (No. 6). 12m. 26chs. Crane and mechanical equipment in use. (85/62)
270	Woodgrange Park and Barking Tilbury Line Jn West	Down and Up	Erecting scaffolding in connection with bridge No. 14A. (85/8)

SUNDAY 16 NOVEMBER

271	South Tottenham East Jn and Woodgrange Park Jn	Down and Up BLOCKED	00 01 to 06 00. Unloading materials.
272	Forest Gate Jn and Barking Station (Country End)	All BLOCKED to electric trains	00 50 to 06 15. In connection with engineering work between Woodgrange Park Jn and Barking Tilbury Line Jn West. <u>Isolation of electrical sections 512 and 513.</u>
273	Woodgrange Park Jn and Barking Tilbury Line Jn West	Down and Up BLOCKED	00 50 to 06 15. Bridgework (No. 14A). Crane and mechanical equipment in use. <u>Possession to be given up for passage of Engineers' trains.</u>

BARKING, TILBURY LINE JN EAST TO TILBURY RIVERSIDE

UNTIL FURTHER NOTICE

274	Dagenham Dock Station	Down and Up	08 00 to 17 00. Construction work. Mechanical equipment in use. (85/14)
275	Rainham Station	Down and Up	08 00 to 17 00. Construction work. Mechanical equipment in use. (85/14)
276	Purfleet Station	Down and Up	09 00 to 16 00. Platform work. Mechanical equipment in use. (85/61)

SECTION B - TEMPORARY ENGINEERING WORKS - continued

At or between	Lines affected	Remarks
<u>TILBURY RIVERSIDE TO PITSEA</u>		
SATURDAY/SUNDAY 15/16 NOVEMBER		
277 Tilbury East Jn and Stanford- le-Hope	Down and Up BLOCKED	23 55 to 06 50. Track maintenance. Mechanical equipment in use.
278 Stanford-le- Hope and Pitsea	Down and Up BLOCKED	23 55 to 17 40. Reballasting, unloading rails, track maintenance and overhead line work. Mechanical equipment in use. <u>Isolation of</u> <u>electrical sections 536CD, 537AB.</u>

SECTION C

SIGNALLING AND PERMANENT WAY ALTERATIONS

* * Items marked thus will not appear in future issues and a note must be
* taken of them by all concerned.

DETAILS OF WORK REFERRED TO IN SECTION B

NIL

DETAILS OF WORK ALREADY CARRIED OUT

NEW HALL

The Up Loop has been taken out of use Until Further Notice.

(UFN)

HATFIELD PEVEREL

The facing and trailing crossovers are out of use until further notice.

(UFN)

* * BETWEEN SWAINSTHORPE AND TROWSE LOWER JUNCTION

*

Swainsthorpe signal box, together with all signalling worked therefrom has been abolished.

New colour light signalling has been commissioned in accordance with the diagram included in this notice.

Except for the section between Trowse Lower Junction (Trowse Yard if open) and Trowse Swing Bridge, which is signalled in accordance with the Absolute Block Regulations, the Track Circuit Block Regulations now apply throughout between Colchester and Trowse Lower Junction, and between Trowse Swing Bridge and Norwich.

Alterations to Existing Signalling

Trowse Lower Junction Up Branch (former Starting) signal No.TL5 has been converted to a 3-aspect signal.

Level Crossings

Swainsthorpe Level Crossing at 109m. 54chs.

This crossing has been converted to an automatic half-barrier crossing. Telephone communication has been provided between the crossing and Colchester Signal Box.

SECTION C - SIGNALLING AND PERMANENT WAY ALTERATIONS - continuedDETAILS OF WORK ALREADY CARRIED OUT - continued* * BETWEEN SWAINSTHORPE AND TROWSE LOWER JUNCTION - continued

*

Swainsthorpe Level Crossing at 109m. 54chs. - continued

The crossing is closed to road traffic and the barriers secured in the lowered position until the associated road works are completed when the barriers will be fully commissioned.

Working in the Wrong Direction

The barriers are equipped to work automatically when approached in the wrong direction, and for this purpose a combined St. Andrew's Cross/50m.p.h. speed restriction sign has been provided 955 yards from the crossing on each rail approach in the wrong direction.

Newton Flotman Automatic Half-Barrier Level Crossing at 108m. 19chs.

The telephones at this crossing have been altered to communicate with Colchester S.B. (previously to Swainsthorpe S.B.).

Catchpoints

The catchpoints in the Up Main at 113m. 21chs. and at 113m. 61chs. (between Trowse Lower Junction and the site of former Trowse Upper Junction), have been secured in the closed position pending removal and replacement by plain line.

Automatic Warning System

A.W.S. has been provided in conjunction with all main line colour light signals.

(34)

* * NORWICH STATION

*

No. 1 Platform line has been shortened by 5 yards and new buffer stops installed.

(34)

WOODHAM FERRERS AUTOMATIC OPEN LEVEL CROSSING AT 34M. 05CHS.

A Plunger (housed in a locked cabinet) has been provided attached to the post carrying the Down side Drivers flashing white light signal.

When the train is ready to depart and the Drivers white light is not illuminating, (providing the train is standing on the Down Platform line,), in order to reactivate the road traffic signals which may have extinguished on account of power failure or have been 'Timed-out', the Driver should unlock the cabinet by means of the Drivers No. 1 key and press the Plunger.

(35)

SECTION C - SIGNALLING AND PERMANENT WAY ALTERATIONS - continuedDETAILS OF WORK ALREADY CARRIED OUT - continuedBETWEEN HETHERSETT AND TROWSE LOWER JUNCTIONHethersett

The Down Main semaphore Starting Signal has been replaced by a 2-aspect (RED/GREEN) colour light signal plated HT13, 35 yards further from the signal box.

The Up Main Home 2-aspect colour light signal No. HTB has been repositioned 1,350 yards further from the signal box on a new right-hand bracket post.

The Up Main colour light Distant signal No. HTA (together with its associated A.W.S. track inductor) has been repositioned 1¼ miles further from the signal box to a position 2,037 yards before reaching the repositioned Up Home signal.

Reference should be made to the associated diagram included in this notice.

Level CrossingsIntwood Automatic Half-barrier Level Crossing at 119m. 47chs.Keswick Automatic Half Barrier Level Crossing at 120m.p.

The barriers at these crossings are equipped to work automatically when approached in the reverse direction and for this purpose, combined St. Andrew's Cross/30m.p.h. speed restriction signs have been provided applicable to each rail approach to the crossings in the wrong direction.

Eaton Minature Warning Lights Level Crossing at 120m. 29chs.

A combined St. Andrew's Cross/30m.p.h. speed restriction sign has been provided applicable to each wrong direction rail approach to Eaton Level Crossing.

A 'Whistle' board has been provided on each rail approach for normal and wrong direction of travel.

The distance of the St. Andrew's Cross/speed restriction signs and 'Whistle' boards from the three level crossings is as shown on the diagram.

(36)

AUDLEY END

3-aspect signal CA47, reading from the Up Main to Down Main at the north end of Audley End Up Platform, has been fitted with AWS equipment, 100 yards on the approach side of the signal.

(36)

SECTION C - SIGNALLING AND PERMANENT WAY ALTERATIONS - continued

DETAILS OF WORK ALREADY CARRIED OUT - continued

BETWEEN GAS FACTORY JN AND EAST HAM

The 60 m.p.h. Permanent Speed Restriction on the Down line between 2m. 73chs. and 6 $\frac{1}{2}$ m.p. has been withdrawn and the following Permanent Speed Restrictions now apply on the Down line:-

- 60 m.p.h. between 2m. 73chs. and 3m. 12chs.
- 70 m.p.h. between 3m. 12chs. and 6m.p.
- 60 m.p.h. between 6m.p. and 6 $\frac{1}{2}$ m.p.

(See Section 'D') (36)

SECTION C - SIGNALLING AND PERMANENT WAY ALTERATIONS - continued

DETAILS OF WORK ALREADY CARRIED OUT - continued

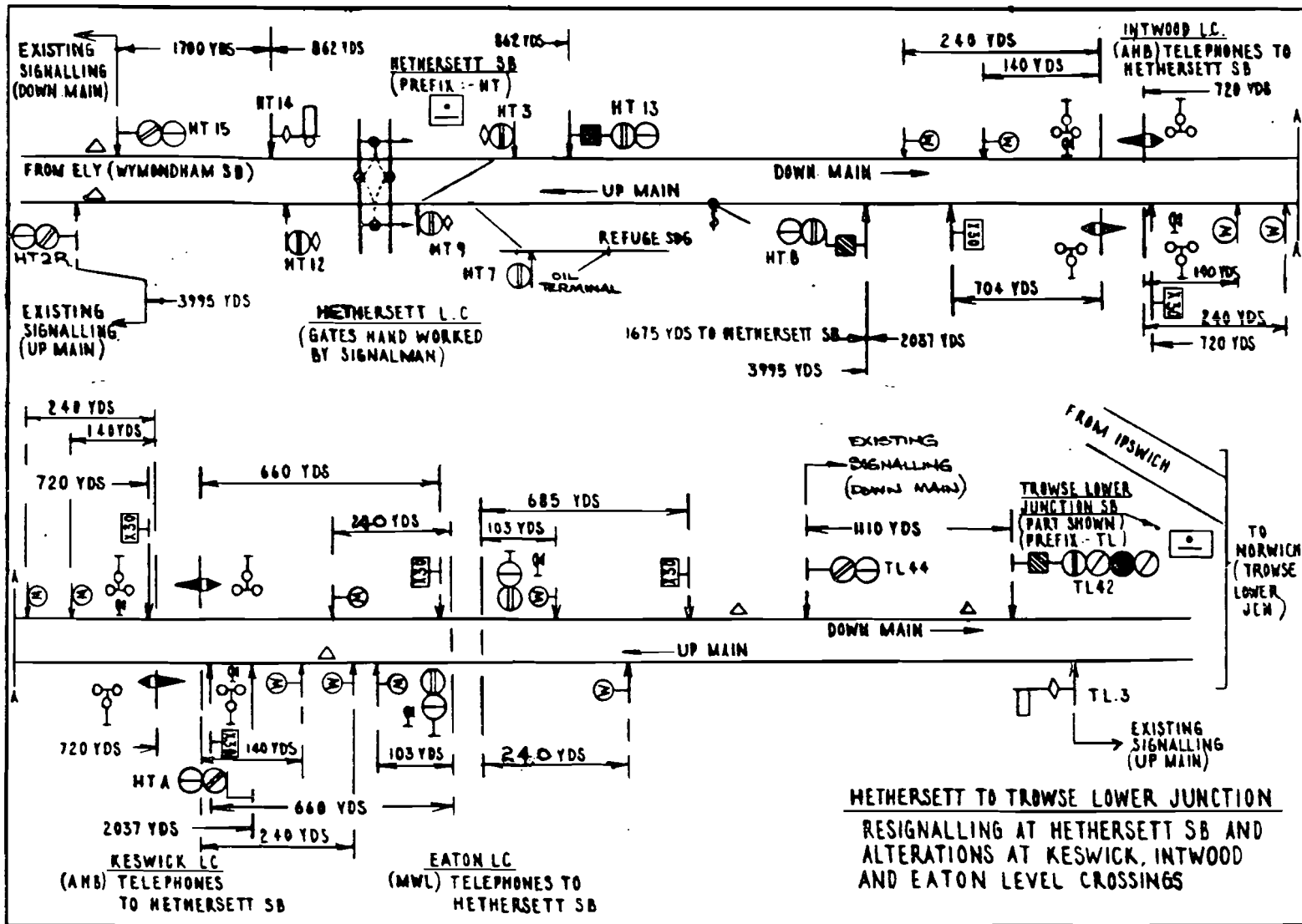

SECTION C - SIGNALLING AND PERMANENT WAY ALTERATIONS - continued

DETAILS OF WORK ALREADY CARRIED OUT - continued

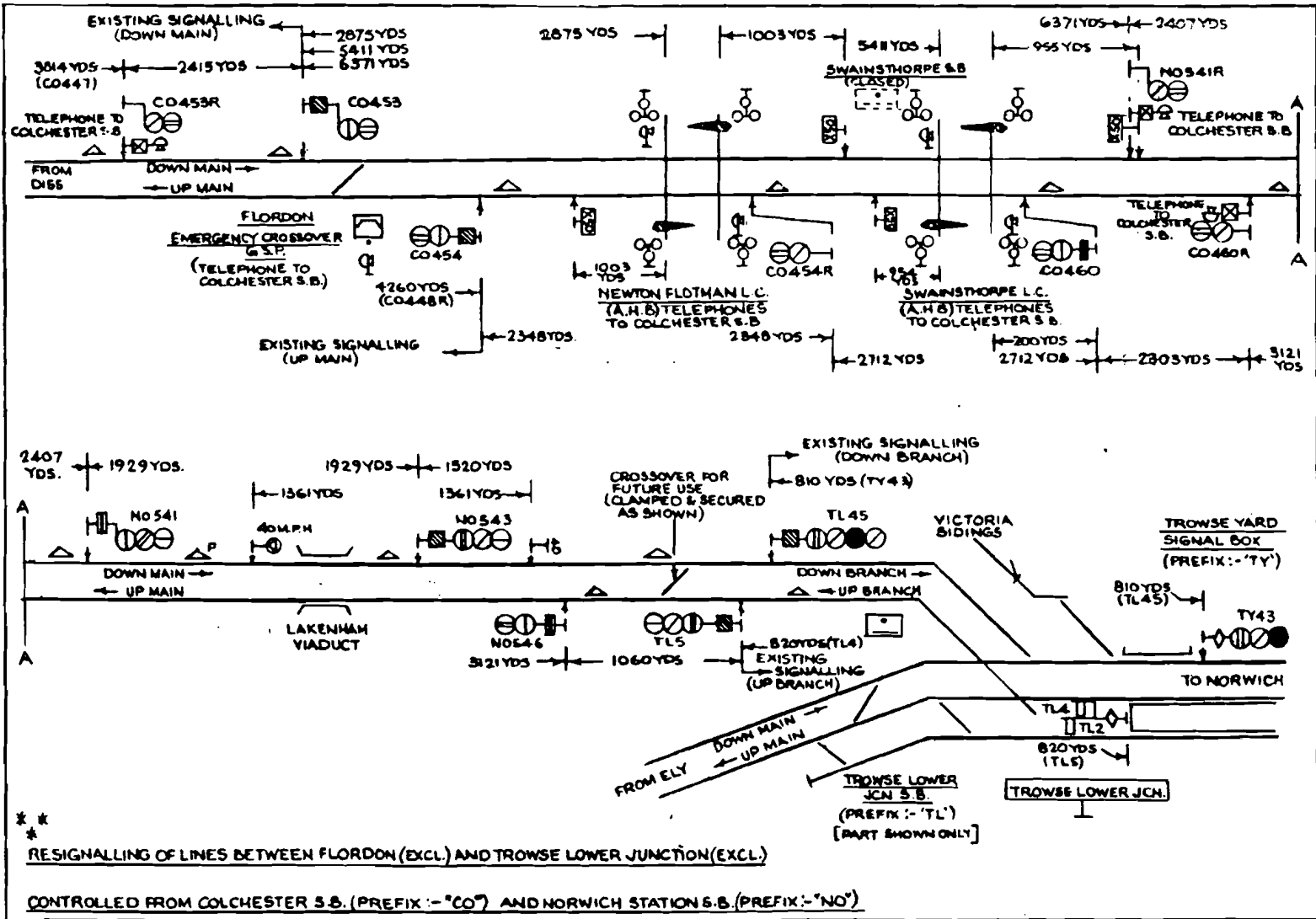

RESIGNALLING OF LINES BETWEEN FLORDON (EXCL.) AND TROWSE LOWER JUNCTION (EXCL.)
 CONTROLLED FROM COLCHESTER S.B. (PREFIX :- 'CO') AND NORWICH STATION S.B. (PREFIX :- 'NO')

SECTION DGENERAL INSTRUCTIONS AND NOTICES

A thick vertical line denotes new or amended items.

* * Items marked thus will not appear in future issues and a note must be taken
* of them by all concerned.

WORKING MANUAL FOR RAIL STAFF
(B.R. 30054)

WHITE PAGES - PART 6

Page C17

Warning - A -

Amend to read:- Wagon conveys dangerous goods ref. 2A - no more than one wagon or one 30' container permitted on Guardless train.

Page C18

Rejected - S -

Amend to read:- Wagon conveys dangerous goods not permitted on Guardless train.

Rejected - T -

Amend to read:- Warning - T - Wagon is of a type which may not be permitted on Guardless train.

Insert:- Warning - ? - Wagon has special handling code XLD refer to conditions of travel to check suitability for Guardless train.

Insert:- Rejected - . - Locomotive not equipped for Guardless train.

Amend:- Rejected - max. no. of D.I.T. locos. exceeded. See GA S2 Cl.1.5/1.7 to read:- GA S2 Pages 2.7-2.10.

Amend:- Rejected - D.I.T. Shunting loco. Must run Class 9. See GA S2 Cl. 1.5/1.7 to read:- GA S2 Pages 2.7-2.10.

Clause D5/2: Delete 2nd sentence.

Clause D5/3: Delete 1st sentence.

Insert "loaded and empty" between "both" and "conditions" in the existing 2nd sentence.

Clause D5/5: Amend "Clauses 12.10(b) and (c)" to read:- "Clauses 12.10.1(b) and (c)".

Clause D5/14: Amend speed of HAA (loaded) to 55.

Clause D9/6: Amend to read:-

It is essential that all handbrakes are fully released before a wagon is moved to prevent damage to the wheels.

SECTION D - GENERAL INSTRUCTIONS AND NOTICES - continued

WORKING MANUAL FOR RAIL STAFF - (B.R. 30054) - continued

WHITE PAGES - PART 6 - continued

Clause D9/6: - continued

Staff must ensure that they are fully aware of the correct method of hand-brake release as it does vary between individual wagon types as shown below:-

- (a) Clockwise to apply - anti-clockwise to release.
- (b) Anti-clockwise to apply - clockwise to release.
- (c) Separate hand-brakes on each bogie of a bogie wagon.
- (d) Both (a) and (b) can apply on a wagon depending on which side of the wagon the brakes are being released from (see D9/1).

After releasing the hand-brakes, wherever possible, staff must check by visual means that the brake has in fact been released by checking "indicators" where fitted, the brake rigging is slack and the hand-brake wheel will not turn any more.

The fact that the hand-brake wheel is slack is no positive indication that the brake has been released.

Clause D9/8: Delete.

(12.SD)

EASTERN REGION SECTIONAL (SOUTHERN APPENDIX AREA)

TABLE A : DETAILS OF RUNNING LINES

Running Lines and Signalling System	Location	M. Ch.	Permanent Speed Restrictions		Remarks
			Down m.p.h.	Up	
<u>LIVERPOOL STREET TO NORWICH</u> <u>Page 57</u> (Page 23, SD PON) At Colchester (CO) <u>Amend</u> 'Remarks' column entry to read:-					Colchester (CO) signal box area between Colchester and Swainsthorpe.

SECTION D - GENERAL INSTRUCTIONS AND NOTICES - continued

EASTERN REGION SECTIONAL APPENDIX (SOUTHERN AREA) - continued

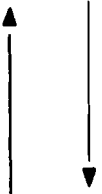
Running Lines and Signalling System	Location	M. Ch.	Permanent Speed Restrictions		Remarks
			Down m.p.h.	Up m.p.h.	
<u>LIVERPOOL STREET TO NORWICH - continued</u>					
Page 60 (Page 23, SD PON)					
At Haughley LC (AHB)					
Amend 'Remarks' column entry to read -					
Pages 60 and 61 (Pages A29 and 24, SD PON)					
Delete all details between Mellis LC (AHB-X) and Trowse Lower Jn and substitute:-					
	Mellis LC (AHB-X)	91 34	X50	X50	<u>Approaching level crossing in wrong direction.</u> Telephone to Colchester signal box at 92m. 77chs. (Signal CO 424R).

SE-57

SECTION D - GENERAL INSTRUCTIONS AND NOTICES - continued

EASTERN REGION SECTIONAL APPENDIX (SOUTHERN AREA) - continued

Running Lines and Signalling System	Location	M. Ch.	Permanent Speed Restrictions		Remarks
			Down m.p.h.	Up m.p.h.	
LIVERPOOL STREET TO NORWICH - continued					
Pages 60 and 61 (Pages A29 and 24, SD PON) - continued:-					
Delete all details between Mellis LC (AHB-X) and Trowse Lower Jn and substitute - continued:-					
	Palgrave LC (AHB-X)	94 04	X50	X50	<u>Approaching level crossing in wrong direction.</u>
	Diss	94 79			
	Audley End (Norfolk) LC (AHB-X)	97 05	X50	X50	<u>Approaching level crossing in wrong direction.</u>
	Burston LC (AHB-X)	97 42	X50	X50	<u>Approaching level crossing in wrong direction.</u>

SE-58

SECTION D - GENERAL INSTRUCTIONS AND NOTICES - continued

EASTERN REGION SECTIONAL APPENDIX (SOUTHERN AREA) - continued

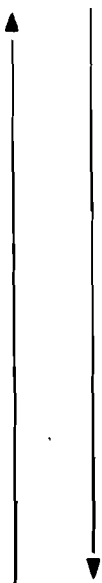
Running Lines and Signalling System	Location	M. Ch.	Permanent Speed Restrictions		Remarks
			Down m.p.h.	Up m.p.h.	
<u>LIVERPOOL STREET TO NORWICH - continued</u>					
Pages 60 and 61 (Pages A29 and 24, SD PON) - continued:-					
Delete all details between Mellis LC (AHB-X) and Trowse Lower Jn and substitute - continued:-					
	Gissing LC (AHB-X)	98 57	X50	X50	<u>Approaching level crossing in wrong direction.</u>
	Hales Street LC (AHB-X)	100 27	X50	X50	<u>Approaching level crossing in wrong direction.</u>
	Tivetshall LC (AHB-X)	100 43	X50	X50	<u>Approaching level crossing in wrong direction.</u>
	Moulton LC (AHB-X)	101 51	X50	X50	<u>Approaching level crossing in wrong direction.</u>
	Flordon	106 63			
					Telephones to Colchester signal box at 104m. 41chs. (Signal CO 448R) and at 105m. 19chs. (Signal CO 453R).

SECTION D - GENERAL INSTRUCTIONS AND NOTICES - continued

EASTERN REGION SECTIONAL APPENDIX (SOUTHERN AREA) - continued

Running Lines and Signalling System	Location	M. Ch.	Permanent Speed Restrictions		At or Between	Remarks	
			Down m.p.h.	Up m.p.h.			
<u>LIVERPOOL STREET TO NORWICH - continued</u>							
Pages 60 and 61 (Pages A29 and 24, SD PON) - continued:-							
Delete all details between Mellis LC (AHB-X) and Trowse Lower Jn and substitute - continued:-							
	Newton Flotman LC (AHB-X)	108 19	X50	X50	Approaching level crossing in wrong direction.	Telephones to Colchester signal box at 110m. 16chs. (Signal NO 541R) and at 111m. 07chs. (Signal CO 460R). Norwich (NO) signal box area between Swainsthorpe (exclusive) and Trowse Lower Jn (exclusive). (12.SD)	
	Swainsthorpe LC (AHB-X)	109 54	X50	X50	Approaching level crossing in wrong direction.		
					90		111m. 15chs. and 110m. 55chs.
					80		111m. 15chs. and 112m. 62chs.
					40		112m. 62chs. and 113m. 46chs.
					35		113m. 46chs. and 123m.p.
	Trowse Lower Jn (See page 103)	113 68 123 00					

SE-60

SECTION D - GENERAL INSTRUCTIONS AND NOTICES - continued

EASTERN REGION SECTIONAL APPENDIX (SOUTHERN AREA) - continued

Running Lines and Signalling System	Location	M. Ch.	Permanent Speed Restrictions		Remarks	
			Down m.p.h.	Up m.p.h.		
<u>BETHNAL GREEN JN TO KING'S LYNN</u> <u>Page 82 (Page 35, SD PON)</u> At Reading Lane Jn <u>Amend:-</u>			<u>10</u>		<u>To Graham Road Curve line.</u> (12.SD)	
<u>READING LANE JN TO NAVARINO ROAD JN (GRAHAM ROAD CURVE)</u> <u>Page 88 (Page 38, SD PON)</u> <u>Delete all details and substitute:-</u> I	Reading Lane Jn (See page 82)	2 55	<u>30</u>	<u>30</u>	MAXIMUM PERMISSIBLE SPEED <u>2m. 55chs. and 2m. 71chs.</u> Controlled by Hackney Downs (H) signal box.	
				<u>10</u>		
	Navarino Road Jn (See page 63)	2 79			Controlled by Dalston Western Jn. (DW) signal box. (12.SD)	

SE-61

SECTION D - GENERAL INSTRUCTIONS AND NOTICES - continued

EASTERN REGION SECTIONAL APPENDIX (SOUTHERN AREA) - continued

Running Lines and Signalling System	Location	M. Ch.	Permanent Speed Restrictions		Remarks
			Down m.p.h.	Up m.p.h.	
<p><u>ELY NORTH JN TO PETERBOROUGH, CRESCENT JN</u></p> <p><u>Page 97</u></p> <p>At Norwood Road LC</p> <p><u>Amend</u> 'Remarks' columns entry to read :-</p>					<p>UGL.76.</p> <p>(12.SD)</p>

SECTION D - GENERAL INSTRUCTIONS AND NOTICES - continued

EASTERN REGION SECTIONAL APPENDIX (SOUTHERN AREA) - continued

Running Lines and Signalling System	Location	M. Ch.	Permanent Speed Restrictions		Remarks	
			Down m.p.h.	Up m.p.h.		
<p><u>ELY NORTH JN TO TROWSE LOWER JN</u></p> <p><u>Page 103</u></p> <p><u>Delete</u> all details between Hethersett and Trowse Lower Jn and <u>substitute:-</u></p>						
	Hethersett (HT) LC	117 73			<p>URS 48 C. Up at 118m. 48chs. (457 yards after passing signal HT B).</p> <p>(12.SD)</p>	
	Intwood LC (AHB-X)	119 47	X30	X30		<u>Approaching level crossing in wrong direction.</u>
	Keswick LC (AHB-X)	120 00	X30	X30		<u>Approaching level crossing in wrong direction.</u>
	Eaton LC (R/G-X)	120 29	X30	X30		<u>Approaching level crossing in wrong direction.</u>
	Trowse Lower Jn (See page 61)	123 00				

SE-63

SECTION D - GENERAL INSTRUCTIONS AND NOTICES - continued

EASTERN REGION SECTIONAL APPENDIX (SOUTHERN AREA) - continued

Running Lines and Signalling System	Location	M. Ch.	Permanent Speed Restrictions		Remarks
			Down m.p.h.	Up At or Between	
<p><u>FENCHURCH STREET TO SHOEBURYNNESS</u></p> <p><u>Pages 104 and 105</u></p> <p><u>Delete all details between Gas Factory Jn and East Ham and substitute:-</u></p>					
	Gas Factory Jn (See page 107)	2 57	<u>20</u>	<u>To Bow Jn line.</u>	
	OHNS	3 75	<u>60</u>	<u>2m. 73chs. and 3m. 12chs.</u>	
			<u>70</u>	<u>3m. 12chs. and 6m.p.</u>	
			<u>60</u>	<u>6m.p. and 2m. 73chs.</u>	
	East Ham	6 40	<u>60</u>	<u>6m.p. and 6½m.p.</u>	
			<u>40</u>	<u>6½m.p. and 7m. 08chs.</u>	
			<u>55</u>	<u>6m. 50chs. and 6m.p.</u>	
					(12.SD)

SE-64

SECTION D - GENERAL INSTRUCTIONS AND NOTICES - continued

EASTERN REGION SECTIONAL APPENDIX (SOUTHERN AREA) - continued

Running Lines and Signalling System	Location	M. Ch.	Permanent Speed Restrictions		Remarks
			Down m.p.h.	Up m.p.h.	
<u>FENCHURCH STREET TO SHOEBURYNESSE - continued</u>					
<u>Page 105</u>					
<u>Delete:-</u>	Dagenham East GF's	11 25			(12.SD)
<u>TILBURY RIVERSIDE TO PITSEA</u>					
<u>Amend:-</u>	Fobbing LC (AHB)	30 34			(12.SD)

SE-65

SECTION D - GENERAL INSTRUCTIONS AND NOTICES - continuedEASTERN REGION SECTIONAL APPENDIX (SOUTHERN AREA) - continuedINSTRUCTIONS RELATING TO THE RULE BOOKPage 264 (Pages 49 and 50, SD PON)POWER OPERATED POINTS - WRONG DIRECTION MOVEMENTS

<u>Signalbox/location</u>	<u>Point Nos.</u>	
<u>Amend</u> East Gate Jn entry to read :-	.	
East Gate Jn	25,29	(12.SD)

OTHER GENERAL INSTRUCTIONSPages 278 and 279 (Pages 56 and 57, SD PON)FIXED AUDIBLE TRACK CIRCUIT OPERATED WARNING SYSTEMS

<u>Location</u>	<u>Description</u>
<u>Add:-</u>	
<u>Fenchurch Street to Shoeburyness</u>	
Christian Street Jn.	Covers Down and Up Main lines between 0m. 62chs. and 0m. 72chs.
Stepney	Two independent systems covering Down and Up lines between:- (i) 1m. 10chs. and 1m. 26chs. (ii) 1m. 26chs. and 1m. 44chs.
	(12.SD)

SECTION D - GENERAL INSTRUCTIONS AND NOTICES - continuedEASTERN REGION SECTIONAL APPENDIX (SOUTHERN AREA) - continuedOTHER GENERAL INSTRUCTIONS - continued

Page 297 (Page A37, SD PON)

DOCKLANDS LIGHT RAILWAY LINE BETWEEN BOW JN AND STRATFORD STATION
(ADJACENT TO THE B.R. UP ELECTRIC LINE)

Delete heading and instructions and substitute:-

DOCKLANDS LIGHT RAILWAY LINES ADJACENT TO B.R. LINES
BETWEEN BOW JN AND STRATFORD AND BETWEEN CHRISTIAN STREET JN AND STEPNEY EAST

B.R. staff must observe the provisions of the previous instructions on pages 294 to 297 headed, "Instructions to Train Crews Working other than D.C. Electric trains and other staff concerned working over or in the vicinity of D.C. Electrified lines", except that reference to Electrical Control Operator should be read as Controller and Supervisor at Poplar Control Centre, who can be contacted via the Signaller at Bow Jn, Stratford or Fenchurch Street or the Electrical Control Operator at Romford or on British Telecom 538 3440.

The Docklands Light Railway when fully operational will work automatically without lineside signals, using Driverless trains which will approach in either direction travelling at a maximum speed of 50 m.p.h. Each train will convey a member of the Docklands Light Railway staff called a "Train Captain".

Docklands trains will not sound a warning to persons on or near the line etc., and B.R. staff must not, therefore, except in emergency go on to the Docklands Light Railway.

Between Bow Jn and Stratford posts are provided in the 10 foot between the Up Electric line and the Docklands line to identify the point beyond which staff must not proceed. When staff stand clear of the Up Electric line they must align themselves between the posts.

Between Christian Street Jn and Stepney East the only position of safety in accordance with Rule Book, Section B, Clause 5.3.4 is on the North (Down) side of the viaduct and on the approach of a B.R. train staff must immediately proceed to the North side.

Between Christian Street Jn and Stepney East and in the vicinity of Bow Jn signal box and overbridge 609 (Fairfield Road), staff must not, except in emergency, proceed beyond the fence between B.R. and Docklands line. If unavoidable circumstances compel staff to remain between the B.R. and Docklands lines when trains pass, they must lay down against the B.R. side of the fence. It is important that this instruction is observed as the collector shoes of Docklands Light Railway trains will pass in close proximity to the Docklands side of the fence.

SECTION D - GENERAL INSTRUCTIONS AND NOTICES - continuedEASTERN REGION SECTIONAL APPENDIX (SOUTHERN AREA) - continuedOTHER GENERAL INSTRUCTIONS - continuedPage 297 (Page A37, SD PON) - continuedDOCKLANDS LIGHT RAILWAY LINES ADJACENT TO B.R. LINES BETWEEN BOW JN AND STRATFORD AND BETWEEN CHRISTIAN STREET JN AND STEPNEY EAST - continued

If an emergency mishap occurs on B.R. lines requiring the stopping of trains on the Docklands Light Railway, standard B.R. protection arrangements must be observed and advice given to the Poplar Control Centre by the quickest available means. It should be noted that the placing of a Track Circuit Operating Clip on the Docklands line will stop a train which is in automatic mode.

(w.e.f. Monday 17 November) (12.SD)

LOCAL INSTRUCTIONSPage 317WICKFORD TO SOUTHMINSTERAdd :- WOODHAM FERRERS A.O.C.L. LEVEL CROSSING

Woodham Ferrers level crossing must be worked in accordance with the General Appendix Instructions for A.O.C.L. level crossings, except that in the event of the red road signals not being automatically initiated, the Driver must press the plunger located in a locked Cabinet (Drivers No. 1 Key) on the White light post to activate the road signals. When the white light is flashing, the Driver may proceed as normal. If, after operation of the plunger, the white light still does not flash, the Driver must proceed in accordance with Clause 3.3 of the instructions.

(12.SD)

Page 327BETHNAL GREEN TO KING'S LYNNAdd:- DOWNHAM MARKET

Drivers of Up stopping passenger trains must stop in rear of the Up section signal, even though the signal may be displaying a green aspect and not proceed forward until the station duties have been completed.

(12.SD)

SECTION D - GENERAL INSTRUCTIONS AND NOTICES - continued

EASTERN REGION SECTIONAL APPENDIX (SOUTHERN AREA) - continued

LOCAL INSTRUCTIONS - continued

Page 333

FENCHURCH STREET TO SHOEBURYNNESS

Add:- BETWEEN CHRISTIAN STREET JN AND STEPNEY EAST

Rule Book, Section B, Clause 5.3.8 and General Appendix Instruction -
Safety of Staff called by Signalman to work on the line

Staff must not commence work on the Up side of a train on the Up line unless they have received an assurance from the Signalman that trains on the Down Docklands line have been stopped.

If staff called by the Signalman to work on the line consider that they cannot work safely with trains running on the Down Docklands line, they must not commence work until an assurance has been received from the Signalman that Down Docklands trains have been stopped.

(w.e.f. Monday 17 November) (12.SD)

MISCELLANEOUS NOTICES

INSTRUCTIONS FOR D.C. ELECTRIFIED LINES
BETWEEN ELSTON-WATFORD JN, CROXLEY GREEN-NORTH WOOLWICH B.R.29636

Supplement No. 2 to the above publication is in the course of being distributed.

Any member of staff who is in possession of the current issue of B.R.29636 who has not received a copy of the Supplement must promptly advise his Supervisor.

(37)

PERMANENTLY COUPLED D.B. 2 x 45 TONNE VANS

The West German Railways are manufacturing 200 45 tonne 2 axle general merchandise vans which will be permanently coupled in 100 pairs.

Each pair of wagons will be identified by a single number in the following range:-

23 80 2794 000-2 to 23 80 2794 099-4

Only one wagon in each pair is fitted with a distributor, and in the event of a coupling breaking the brakes would only apply on the wagon fitted with the distributor - the air supply to the "slave wagon" would be lost when the pipes parted.

SECTION D - GENERAL INSTRUCTIONS AND NOTICES - continued

MISCELLANEOUS NOTICES - continued

PERMANENTLY COUPLED D.B. 2 x 45 TONNE VANS - continued

For this reason:-

1. These wagons must not be included in a fully fitted block train of this type of wagon.
2. These wagons must not be included in the rear-most three positions of any other fully fitted freight train.
3. Any train including a pair of these wagons, must consist of a minimum of 5 vehicles, to avoid these D.B. wagons being in the last three.

The TOPS trainlist programme will be altered as soon as possible to reflect this.

(12.D)

WORKING INSTRUCTIONS FOR A.C. ELECTRIFIED LINES - BR.29987

From 1st December 1986, a new book will take effect which will replace the current edition dated 3rd May 1975 and the amendments thereto.

The book will be in loose leaf form, A5 size, with a flexible cover and its format has been designed so that part of the book can be separately issued in place of the existing "Extracts from the Working Instructions" book BR.29988, which will be discontinued from the same date.

The new book is divided into three main sections viz:-

Section A (BR.29987) - Definitions, Description of System and General Instructions. This will be issued to every employee working on or in the vicinity of lines electrified on the A.C. overhead line system.

Section B (BR.29987/14) - Isolation and Earthing of Overhead Line Equipment.

Section C (BR.29987/15) - Protection of Staff Servicing/Maintaining Locomotives or Trains in Sidings/Depots equipped for electric traction.

Note: Sections B and C will be issued only to staff involved with the instructions contained therein.

The new book is currently being distributed and the appropriate section(s), together with a copy of the explanatory leaflet, BR.29987/16, must be made available to staff immediately upon receipt.

Any member of the staff who is in possession of the current issue of the A.C. Working Instructions, or Extracts thereto, who has not received a copy of the appropriate section(s) of the new book must promptly advise his Supervisor.

SECTION D - GENERAL INSTRUCTIONS AND NOTICES - continued

MISCELLANEOUS NOTICES - continued

GREAT EASTERN ELECTRIFIED LINES : BARKING AREA

INSTALLATION OF DEAD SECTION

A DEAD SECTION has been installed at overhead line structure number A7/12 at 7m. 12chs. on the UP MAIN, London side of Barking Flyover. (12.SD)

WORKING OF CLASS 313 AND CLASS 416 ELECTRIC MULTIPLE UNIT
TRAINS BETWEEN DALSTON WESTERN JN AND STRATFORD MARKET

Class 313 Electric Multiple Units

These units must only work between Navarino Road Jn and Stratford Market stabling sidings when either the Graham Road Curve route to Liverpool Street is not available, or when the pantographs have failed to rise. When operating between Dalston Kingsland and Stratford Market stabling sidings and return in the D.C. mode, Drivers must not advance the controller beyond Notch 2.

THESE UNITS MUST NOT RUN BEYOND STRATFORD MARKET TOWARDS NORTH WOOLWICH.

Class 416 Electric Multiple Units

Not more than two Class 416 units may be coupled together.

When two Class 416 units are running in multiple between Dalston Western Jn and Stratford Market, including the stabling sidings or return, Drivers must not advance the controller beyond Notch 2.

(UFN)

BETWEEN STEPNEY EAST AND FENCHURCH STREET

Until further notice, staff of the Docklands Light Railway will be laying in track adjacent to the Up Main/Slow line between Stepney East Station (1m. 58chs.) and Fenchurch Street. Restricted clearances exist and Drivers must keep a sharp look out and be prepared to sound the warning horn as necessary.

(UFN)

BETHNAL GREEN STATION

Until Further Notice, whilst demolition work is taking place, Drivers of 4-Car EMU trains must stop their trains at the temporary stop boards provided.

(UFN)

SECTION D - GENERAL INSTRUCTIONS AND NOTICES - continuedMISCELLANEOUS NOTICES - continuedCAMBRIDGE HEATH STATION

Whilst platform repairs are taking place, Drivers of trains must stop their trains at the temporary stop boards provided.

(UFN)

LONDON FIELDS STATION

The station has reopened but platform repairs are taking place. Whilst this work is being carried out, Drivers must stop their trains at the temporary stop boards provided.

(UFN)

SAWBRIDGEWORTH STATION

The stop board on the Up platform has been temporarily moved 9 yards towards the Country side of its former position.

(UFN)

WANSTEAD PARK STATION

Whilst platform repairs are taking place, Drivers of Up trains must stop their trains at the temporary stop boards provided.

(UFN)

REPAIRS IN MOTIVE POWER DEPOTS, CARRIAGE SHEDS, WAGON REPAIR SHEDS AND WAREHOUSES

In connection with work being carried out at the undermentioned places, scaffolding or projections may be provided or unusual excavations may be made in the ground:-

Location	Nature of Work	Duration	Commencing date
Stratford T.M.D. All lines.	Repairs to Motive Power Depot. Cranes and mechanical equipment in use.	Continuously. Until Further Notice.	-
Ilford EMU Depot, Nos. 19 and 20 Roads.	Drainage.	08 00 to 17 00 daily. Until Further Notice.	-
Ilford EMU Depot, 'B' Shop Roads Nos. 3, 4 and 5.	Construction work. <u>Isolation of electrical sections C3, 4 and 5.</u>	Continuously. Until further notice.	-

SECTION D - GENERAL INSTRUCTIONS AND NOTICES - continuedMISCELLANEOUS NOTICES - continuedREPAIRS IN MOTIVE POWER DEPOTS, CARRIAGE SHEDS, WAGON REPAIR SHEDS AND WAREHOUSES

In connection with work being carried out at the undermentioned places, scaffolding or projections may be provided or unusual excavations may be made in the ground:-

Location	Nature of Work	Duration	Commencing date
Ilford EMU Depot, Nos. 6, 7, 8, 9 and 10 Sidings (Country End) BLOCKED	Track renewal.	Continuously. Until further notice.	-
Ilford EMU Depot Nos. 1 and 1A Ley Street Sidings BLOCKED	Construction work. <u>Isolation of electrical sections 361U.</u>	Continuously.	<u>From 09 30 Saturday 15 until 16 00 Sunday 16 November.</u>
Norwich Crown Point T & R.S. M.D., All lines BLOCKED	Construction work (overhead line) and track maintenance. Mechanical equipment in use. <u>Possession to be given up for passage of trains.</u>	08 00 to 17 00 daily. Until further notice.	-
East Ham EMU Depot, All lines.	Shed reconstruction.	Continuously. Until Further Notice.	-
East Ham EMU Depot, Washer Road BLOCKED	Repairs to washer plant. <u>Isolation of electrical sections 509A.</u>	Continuously. Until Further Notice.	-
East Ham EMU Depot, Nos. 10 and 11 Maintenance Shed Roads BLOCKED	Construction work. <u>Isolation of electrical sections EH10, EH11.</u>	Continuously. Until Further Notice.	-

P.O.I.S. - THE FACTS (NO. 1)

INFORMATION ON TRAIN REPORTS REQUIRES TO BE ENTERED TO
P.O.I.S. AS SOON AS POSSIBLE AFTER ARRIVAL AT
DESTINATION.

GUARDS - PLEASE HAND IN COMPLETED FORMS PROMPTLY AT
DESIGNATED POINT.

BRITISH RAIL
EASTERN REGION

SE

35

WEEKLY OPERATING NOTICE

CONTAINING

TEMPORARY SPEED RESTRICTIONS

TEMPORARY ENGINEERING WORKS

SIGNALLING AND
PERMANENT WAY ALTERATIONS

GENERAL INSTRUCTIONS AND NOTICES

SATURDAY 22 NOVEMBER

TO

FRIDAY 28 NOVEMBER 1986

INCLUSIVE

Trainmen must pay particular attention to works contained in this notice and keep a good look-out for handsignals which may be exhibited in accordance with the Rules and Regulations.

Work at places other than those mentioned may be in progress and Driver's must be on the look-out and be prepared to stop or run at reduced speed when, and where, handsignals may be exhibited.



WARNING



A.C. ELECTRIFIED LINES - ANGLIA EAST

EXTENSION OF ELECTRIFICATION FROM HAUGHLEY JUNCTION TO TIVETSHALL

The Overhead Line Equipment has been extended from Haughley Junction, through Diss to Tivetshall.

From 00 01 hours, Monday, 1st December 1986, the Overhead Line Equipment will be energised at 25,000 Volts and must thereafter be regarded as being 'ALIVE' at all times.

The limits of energisation will be:-

At 100 mile post south of Tivetshall.

Structure Nos. B161/03 DOWN MAIN
B161/04 UP MAIN

The Working Instructions for A.C. Electrified Lines (B.R. 29987) will apply.

(37)



WARNING



*
* ENERGISATION OF DOCKLANDS LIGHT RAILWAY BETWEEN *
* DELTA JUNCTION, STEPNEY EAST, CHRISTIAN STREET *
* JUNCTION AND TOWER GATEWAY. (ADJACENT TO *
* B.R. FENCHURCH STREET TO BARKING LINE). *
*
* The Conductor Rails between Delta Junction and Tower Gateway have *
* been energised at 750 volts D.C. and must be regarded as 'ALIVE' *
* at all times. *
* (12.SD) *
*

SECTION A

TEMPORARY SPEED RESTRICTIONS

(Until further notice unless otherwise specified)

Warning Boards and Indicators provided unless otherwise shown.

† Indicates that the Warning Boards and Indicators will be moved as the work progresses. Where two speeds are shown for a restriction e.g. 20 the Rule Book, Section U, Clause 1.2 applies. 40

RULE BOOK : SECTION U

An experimental speed indicator board with black figures on a yellow background will be used in the Warning Board and Speed Indicator board for the following Temporary Speed Restriction:-

Church Lane LC	Down	Up	29 24	29 57	20	Trackwork.
and Chelmsford						

In addition to the above equipment an experimental black and white zebra striped board with twin high powered flashing white lights will be located at the A.W.S. temporary magnet for the Temporary Speed Restriction shown above. This board with lights does not affect the conditions for Drivers working over the Temporary Speed Restriction, being located only for the purpose of obtaining reactions to their effectiveness for sighting.

Drivers and Traction Inspectors encountering the experimental indicators are requested to submit their comments to the Regional Operations Manager, York under reference M045/1274 via their Local Supervisor.

Location	Lines affected		Mileage		Restr- m.p.h.	Remarks
			at or between M. Ch. M. Ch.	iction		
<u>LIVERPOOL STREET TO NORWICH</u>						
1 Bethnal Green Station Jn and Bow Jn	Down Main	Up Main	1 60	2 10	20	Trackwork. (86/33)
2 Bow Jn	Down Main	-	2 60	2 69	20	Bridgework (No. 46). (86/34)
3 Bow Jn	Down Electric	-	2 60	2 69	20	Bridgework (No. 46). (86/31)

SECTION A - TEMPORARY SPEED RESTRICTIONS - continued

Location	Lines affected		Mileage		Restr- iction m.p.h.	Remarks
			at M.	or between Ch. M. Ch.		
<u>LIVERPOOL STREET TO NORWICH - continued</u>						
4 Bow Jn	-	Up Main	2 69	2 60	20	Bridgework (No. 46). <u>Warning</u> <u>board also</u> <u>provided on</u> <u>Up Cambridge</u> <u>line at</u> <u>3m. 12chs.</u> (86/34)
5 Bow Jn	-	Up Electric	2 69	2 60	20	Bridgework (No. 46). <u>Warning</u> <u>boards also</u> <u>provided on</u> <u>Up Main line</u> <u>at 3m. 27chs.</u> <u>and on Up</u> <u>Cambridge</u> <u>line at</u> <u>3m. 12chs.</u> (86/34)
6 Brentwood and Shenfield	Down Main	-	18 28	18 39	40	Trackwork. <u>From 14 00</u> <u>Monday 24</u> <u>until 10 00</u> <u>Friday 28</u> <u>November.</u>
7 Brentwood and Shenfield	Down Electric	-	19 15	19 20	20	Condition of track. (86/33)
8 Brentwood and Ingatestone	Down Main	-	19 65	20 33	50	Condition of track. (86/14)
9 Church Lane LC and Chelmsford	Down	Up	29 24	29 57	20	Trackwork. (86/26)
10 Chelmsford and New Hall G.F.	Down	-	30 50	30 65	50	Condition of track. (86/12)

SECTION A - TEMPORARY SPEED RESTRICTIONS - continued

Location	Lines affected		Mileage at or between		Restr- iction m.p.h.	Remarks
			M.	Ch.		
<u>LIVERPOOL STREET TO NORWICH - continued</u>						
11 New Hall G.F. and Witham	Down	-	35 65	36 20	30	Trackwork. From 23 00 <u>Saturday 22</u> until 16 00 <u>Sunday 23</u> <u>November.</u>
12 Witham and New Hall G.F.	-	Up	36 20	35 65	20	Earthwork. (86/28)
13 Hatfield Peverel and Witham	Down	-	37 20 †	38 00	40	Condition of track. (86/28) <u>Until 10 00</u> <u>Friday 28</u> <u>November.</u>
14 Kelvedon	-	Up	42 25	42 10	<u>50</u> 80	Condition of track. (86/7)
15 Palgrave LC and Rectory Road LC	-	Up	91 40	91 20	20	Earthwork. (86/28) <u>Until 10 00</u> <u>Friday 28</u> <u>November.</u>
16 Trowse Lower Jn and Swainsthorpe LC	-	Up	112 60	112 40	30	Trackwork. From 22 00 <u>Saturday 22</u> <u>November.</u> (86/35)
<u>SHENFIELD JN TO SOUTHEND VICTORIA</u>						
17 Billericay and Wickford Station	Down	-	26 10	26 44	40	Condition of track. (86/14)
18 Wick Lane LC and Rayleigh	Down	-	31 35	31 75	40	Condition of embankment. (84/41)

SECTION A - TEMPORARY SPEED RESTRICTIONS - continued

Location	Lines affected	Mileage at or between		Restr- iction m.p.h.	Remarks	
		M. Ch. M.	Ch. M. Ch.			
<u>WICKFORD JN TO SOUTHMINSTER</u>						
19 Althorne LC and Burnham-on- Crouch	Single	41 10 †	42 10	20	Trackwork. (85/45)	
<u>WITHAM TO BRAINTREE</u>						
20 Cressing and Braintree	Single	18 75	18 68	20	Bridgework (No. 2102B). (86/29)	
<u>COLCHESTER TO CLACTON</u>						
21 Colchester Road - LC and Wivenhoe	Up	57 72 †	57 12	40	Condition of track. (86/26)	
<u>MANNINGTREE SOUTH JN TO HARWICH</u>						
22 Parkeston Goods - Jn and Wrabness	Up	66 70	66 10	<u>30</u> 50	Condition of track. (86/3)	
<u>EAST SUFFOLK JN TO OULTON BROAD NORTH JN</u>						
23 Bealings LC and Westerfield Jn	Up	74 60 †	73 44	30	Condition of track. (86/33)	
<u>WESTERFIELD JN TO FELIXSTOWE</u>						
24 Trimley	Single	82 55	82 69	30	Trackwork. (86/33)	
<u>NORWICH TO LOWESTOFT</u>						
25 Thorpe Jn and Whitlingham Jn	Down	Up	0 36	0 44	20	Trackwork. (85/20)
26 Brundall Gardens and Brundall Jn	Down	-	5 50	5 65	30	Trackwork. <u>Until 10 00</u> <u>Wednesday 26</u> <u>November.</u> (86/34)

SECTION A - TEMPORARY SPEED RESTRICTIONS - continued

Location	Lines affected		Mileage		Restr- iction m.p.h.	Remarks
			at or between M. Ch. M. Ch.			
<u>BETHNAL GREEN JN TO KING'S LYNN</u>						
27 Tottenham South Jn	Down	-	5 39	5 43	20	Condition of track. (86/32)
28 Angel Road and Brimsdown	Down	Up	9 60	10 02	20	Trackwork. (86/30) <u>Until 14 00</u> <u>Monday 24</u> <u>November.</u>
29 Enfield Lock	Down	Up	11 60	11 71	50	Condition of track. (86/31)
30 Sawbridgeworth and Harlow Mill	-	Up	24 76	24 70	60	Condition of track. (86/16)
31 Ickleton Road LC and Hinxton LC	Down	-	46 00	46 60	20	Trackwork. <u>From 00 10</u> <u>until 16 00</u> <u>Sunday 23</u> <u>November.</u>
32 Hinxton LC and Ickleton Road LC	-	Up	46 60	46 00	20	Trackwork. <u>From 00 10</u> <u>Sunday 23</u> <u>November.</u> (86/35)
33 Whittlesford Station	-	Up	49 10	49 00	40	Platform work. (86/35)
<u>HACKNEY DOWNS NORTH JN TO ENFIELD TOWN</u>						
34 Stamford Hill	-	Up	5 12	4 78	20	Condition of track. (86/34)
35 Silver Street and Bury Street Jn	Down	Up	8 40	8 67	20	Trackwork. (86/34)

SECTION A - TEMPORARY SPEED RESTRICTIONS - continued

Location	Lines affected	Mileage		Restr- iction m.p.h.	Remarks	
		at or between M. Ch. M. Ch.				
<u>ELY NORTH JN TO PETERBOROUGH, CRESCENT JN</u>						
36 Third Drove LC and Welney Road LC	Down	Up	78 00	78 18	20	Condition of track. (86/21)
37 Third Drove LC and Welney Road LC	Down	Up	78 42	78 60	20	Condition of track. (86/21)
38 March East Jn and Badgeney Road LC	-	Up Main	85 36	85 32	10	Condition of track. <u>Warning board</u> <u>positioned at</u> <u>signal ME.45.</u> <u>Additional</u> <u>warning board</u> <u>provided on</u> <u>the March</u> <u>East Jn to</u> <u>Wisbech line,</u> <u>positioned at</u> <u>signal ME.52.</u> (86/31)
39 Three Horse Shoes No. 3 LC	Down	Up	90 74	90 78	<u>20</u> 50	Condition of track. (86/24)

Warning board at 100m. 25chs. (on the Down line) applies only to trains
proceeding over the Down Fast line at Peterborough Station (North). Until
01 00 Sunday 23 November.

ELY NORTH JN TO TROWSE LOWER JN

40 Hethersett and Trowse Lower Jn	Down	-	118 60	120 30	60	Signalling work. (86/33)
41 Trowse Lower Jn and Hethersett	-	Up	121 15	119 47	60	Signalling work. (86/33)
42 Eaton LC and Trowse Lower Jn	Down	Up	121 60	121 64	20	Bridgework (Nos. 1640 and 1640A). (86/23)

SECTION A - TEMPORARY SPEED RESTRICTIONS - continued

Location	Lines affected		Mileage		Restr- iction m.p.h.	Remarks
			M. Ch. M.	Ch. M. Ch.		
<u>FENCHURCH STREET TO SHOEBURYNESS</u>						
43 Gas Factory Jn and Barking Tilbury Line Jn West	Down	Up	4 02	4 38	20	Trackwork. (86/31) Until 14 00 <u>Sunday 23</u> <u>November.</u>
44 Gas Factory Jn and East Ham	Down	Up	4 02 †	4 22	20	Trackwork. From 14 00 <u>Sunday 23</u> <u>November.</u> (86/35)
<u>UPPER HOLLOWAY TO BARKING, TILBURY LINE JN WEST</u>						
45 South Tottenham East Jn and Black Horse Road	Down	-	6 45	6 57	20	Condition of track. (85/18)
46 Walthamstow Queens Road and Leyton Midland Road	Down	Up	8 34	8 39	20	Trackwork. From 14 00 <u>Wednesday 26</u> <u>November.</u> (86/35)
<u>TILBURY RIVERSIDE TO PITSEA</u>						
47 Stanford-le- Hope and Gardners LC	Down	-	30 11	30 60	20	Trackwork. (86/34)
48 Gardners LC and Stanford-le- Hope	-	Up	30 60	30 11	30	Trackwork. (86/34)

SECTION B

TEMPORARY ENGINEERING WORKS

At or between	Lines affected	Remarks
<u>LIVERPOOL STREET TO NORWICH</u>		
UNTIL FURTHER NOTICE		
49	Liverpool Street Station	Platform 1 Demolition work. Mechanical equipment in use. (86/30)
50	Liverpool Street Station	Platforms 1 to 10 Inc. Repairs to station roof. Mechanical equipment in use. (84/41)
51	Liverpool Street Station	Platforms 1 to 18 inc. Cleaning track. (85/21)
52	Liverpool Street Station	Platforms 8, 10 and 11 to 18 inc. Platform work and construction work. Mechanical equipment in use. (86/21)
53	Liverpool Street	Platform 10 Shunt Spur BLOCKED <u>Track maintenance and track renewal. Until 18 00 Sunday 23 November.</u> (86/33)
54	Bethnal Green Station	Down Main and Down and Up Suburban 08 00 to 16 00. Demolition work. (See Section 'D'). (85/41)
55	Bethnal Green and Bow Jn	All Signalling work. (86/25)
56	Stratford and Bow Jn	Up Electric 07 30 to 18 00. Construction work. Mechanical equipment in use. (85/62)
57	Forest Gate Jn and Ilford	All 07 00 to 18 00. Bridgework (No. 75A). 7m. 08chs. Mechanical equipment in use. (85/20)
58	Ilford Station	All 08 00 to 17 00. Repairs to station roof and painting station. (86/2)
59	Romford Jn and Gidea Park	All Bridgework (No. 102B). 12m. 48chs. Crane and mechanical equipment in use. (85/54)

SECTION B - TEMPORARY ENGINEERING WORKS - continued

<u>At or between</u>	<u>Lines affected</u>	<u>Remarks</u>	
<u>LIVERPOOL STREET TO NORWICH - continued</u>			
UNTIL FURTHER NOTICE - continued			
60	Ingatestone and Chelmsford	Down and Up	07 30 to 18 00. Construction of bridge (No. 143A). 26m. 51chs. Mechanical equipment in use. (84/35)
61	Mellis LC and Trowse Lower Jn	All <u>Between Trains</u>	07 30 to 18 00. Signalling work. Points and signals disconnected. (86/15)
62	Diss	Down and Up	07 00 to 19 00. Earthwork. Crane and mechanical equipment in use. (85/27)
63	Diss and Audley End LC	Down and Up	Bridgework (No. 315). 95m. 29chs. (86/16)
64	Gissing LC	Down and Up	08 00 to 16 00. Level crossing road repairs. 98m. 56chs. Mechanical equipment in use. (86/26)
65	Hales Street LC	Down and Up	08 00 to 16 00. Level crossing road repairs. 100m. 26chs. Mechanical equipment in use. (86/28)
66	Tivetshall LC	Down and Up	07 30 to 18 00. Demolition work and level crossing road repairs. (Tivetshall LC). 100 $\frac{3}{4}$ m.p. Mechanical equipment in use. (86/28)
67	Newton Flotman LC	Down and Up	08 00 to 16 00. Level crossing road repairs. 108m. 17chs. Mechanical equipment in use. (86/26)
68	Swainsthorpe LC	Down and Up <u>Between Trains</u>	07 30 to 18 00. Level crossing road repairs and demolition work. 109m. 52chs. and 109 $\frac{1}{2}$ m.p. Mechanical equipment in use. (86/30)
69	Swainsthorpe LC and Trowse Lower Jn.	Down and Up	07 00 to 16 00. Bridgework (No. 346). 110m. 62chs. Mechanical equipment in use. (86/25)

SECTION B - TEMPORARY ENGINEERING WORKS - continued

At or between	Lines affected	Remarks
---------------	----------------	---------

LIVERPOOL STREET TO NORWICH - continued

UNTIL FURTHER NOTICE - continued

70	Trowse Lower Jn and Norwich Station	All <u>Between Trains</u>	07 00 to 17 00. Construction work (overhead line), earthwork, track maintenance and signalling work. Points and signals disconnected. (86/7)
71	Trowse Swing Bridge	Down and Up <u>Between Trains</u>	Bridgework (No. 356). 123m. 36chs. Crane and mechanical equipment in use. (85/33)
72	Trowse Swing Bridge and Thorpe Jn	Down and Up <u>Between Trains</u>	07 30 to 18 00. Construction work. 123 $\frac{1}{2}$ m.p. Crane and mechanical equipment in use. (86/3)

FRIDAY/SATURDAY 21/22 NOVEMBER

73	Gidea Park Jn and Shenfield (London End Jn)	Down and Up Main <u>BLOCKED</u>	21 15 to 05 00. Track maintenance, unloading materials, undertrack excavation and overhead line work. Mechanical equipment in use. <u>Isolation of electrical sections 331D, 332A. Trains to travel over Electric lines.</u>
----	---	---------------------------------	--

FRIDAY 21 TO MONDAY 24 NOVEMBER

74	Bethnal Green and Bow Jn	Down and Up Main <u>BLOCKED</u>	23 00 Fri to 05 00 Mon. Bridgework (No. 36), signalling work and overhead line work. Mechanical equipment in use. <u>Isolation of electrical sections 311B, 312B. 23 00 Fri to 12 00 Sat Trains to travel over Electric lines. 12 00 to 23 15 Sat, 02 15 to 04 15 Sun, and 13 30 Sun to 04 00 Mon. Diesel trains to/from Stratford direction to travel over Up Electric (between Bow Jn and Wheler Street Jn)/Up Main (between Wheler Street Jn and Liverpool Street) line under single line working. Trains to/from Hackney Downs direction to travel over Suburban lines between Liverpool Street and Bethnal Green (Country End). 04 00 to 05 00 Mon Trains to travel over Electric lines.</u>
----	--------------------------	---------------------------------	---

SECTION B - TEMPORARY ENGINEERING WORKS - continued

At or between	Lines affected	Remarks
---------------	----------------	---------

LIVERPOOL STREET TO NORWICH - continued

FRIDAY 21 TO MONDAY 24 NOVEMBER - continued

75 Bethnal Green and Bow Jn	Down Electric	23 00 Fri to 12 00 Sat)	Bridgework (No. 36), signalling
	Up Electric	23 00 Fri to 04 00 Mon)	work and overhead line
	Down Electric BLOCKED	12 00 Sat to 04 00 Mon)	work. Mechanical equipment in
Bethnal Green and Stratford (London End)	Down and Up Electric BLOCKED to electric trains	12 00 Sat to 04 00 Mon)	use. <u>12 00 Sat to 04 00 Mon</u> <u>Isolation of electrical sections 309A, 310B.</u> <u>12 00 to 23 15 Sat, 02 15 to 04 15 Sun, and 13 30 Sun to 04 00 Mon.</u> <u>Diesel trains to/from Stratford direction to travel over Up Electric (between Bow Jn and Wheler Street Jn)/Up Main (between Wheler Street Jn and Liverpool Street) line under single line working.</u> <u>Trains to/from Hackney Downs direction to travel over Suburban lines between Liverpool Street and Bethnal Green (Country End).</u>

SECTION B - TEMPORARY ENGINEERING WORKS - continued

At or between	Lines affected	Remarks
<u>LIVERPOOL STREET TO NORWICH - continued</u>		
SATURDAY 22 NOVEMBER		
76 Liverpool Street Station	Platforms 8, 9 and 10 BLOCKED Platform 7 and London End Entry/Exit to/from Locomotive Holding Sidings BLOCKED to electric trains	05 00 to 12 30. Repairs to station roof and construction work. Mechanical equipment in use. <u>Isolation of electrical sections 305CEFGH.</u> <u>Trains to be replatformed as necessary.</u>
77 Liverpool Street Station	Platforms 16 and 17 BLOCKED	12 00 to 23 15. Construction work. Mechanical equipment in use. <u>Trains to be replatformed as necessary.</u>
78 Liverpool Street Station	Platforms 11 to 18 inc. BLOCKED to electric trains	12 00 to 23 15. In connection with engineering work. <u>Isolation of electrical sections 301BCDE, 302ABCD, 304ABCDEF.</u> <u>12 00 to 23 00 Diesel trains to travel to/from Platform 11. Electric trains to be replatformed as necessary.</u> <u>23 00 to 23 15 Electric trains to be replatformed as necessary.</u>
79 Romford and Brentwood	All	01 00 to 02 30. Signalling work. Points and signals disconnected.
SATURDAY 22 TO SUNDAY 23 NOVEMBER		
80 Flordon and Trowse Lower Jn	Down <u>Between Trains</u> Up BLOCKED Down BLOCKED Down and Up	22 00 to 23 55 Sat) Track maintenance,) track renewal and 22 00 Sat to 16 00) signalling work.) Crane and 23 55 Sat to 06 45) mechanical) equipment in use. 16 00 to 18 00 Sun) 06 45 to 16 00 Sun) <u>Single line working</u>) <u>over Down line.</u>

SECTION B - TEMPORARY ENGINEERING WORKS - continued

At or between	Lines affected	Remarks
<u>LIVERPOOL STREET TO NORWICH - continued</u>		
SATURDAY/SUNDAY 22/23 NOVEMBER		
81 Goodmayes Jn and Gidea Park Jn	Down and Up Main BLOCKED	23 00 to 07 00. Track maintenance, track renewal and undertrack excavation. <u>Trains to travel over Electric lines.</u>
82 Gidea Park Jn and Shenfield (London End Jn)	Down and Up Main BLOCKED Down and Up Electric	23 59 to 18 00. Drainage, track maintenance and overhead line work Mechanical equipment in use. <u>Isolation of electrical sections 331D, 332A. Trains to travel over Electric lines.</u>
83 Colchester	All	22 00 to 07 00. Signalling work.
84 Stowmarket Station (London End) and Haughley Jn	All BLOCKED	23 35 to 07 30. Track maintenance. Mechanical equipment in use. <u>Possession to be given up for passage of trains.</u>
85 Haughley Jn	All BLOCKED	23 35 to 07 30. Track maintenance. Mechanical equipment in use.
86 Haughley Jn and Diss	Up BLOCKED Down BLOCKED	22 00 to 07 15)Track maintenance)and loading rails. 23 30 to 10 15)Crane and mechanical)equipment in use.
87 Diss and Flordon	Up BLOCKED Down BLOCKED	22 00 to 07 00)Loading materials)and track renewal. 23 50 to 10 00)Crane and mechanical)equipment in use.
88 Trowse Lower Jn and Trowse Swing Bridge	Down and Up BLOCKED	23 55 to 06 45. Track maintenance. Mechanical equipment in use. <u>Possession to be given up for passage of trains.</u>
89 Trowse Swing Bridge and Norwich Station	'C' line/Up Main BLOCKED Down Main/'W' line BLOCKED	23 00 to 06 45)Construction work) (overhead line) and 23 59 to 07 00)loading materials.) <u>Possession to be given up for passage of 1P04 02 10</u>) <u>Liverpool Street to Yarmouth.</u>

SECTION B - TEMPORARY ENGINEERING WORKS - continued

At or between	Lines affected	Remarks
---------------	----------------	---------

LIVERPOOL STREET TO NORWICH - continued

SATURDAY/SUNDAY 22/23 AND SUNDAY 23 NOVEMBER - continued

92	Church Lane LC and New Hall G.F.	Up Main BLOCKED Down Main BLOCKED Down Main	23 25 Sat to 13 45 00 10 to 13 50 Sun 13 50 to 16 00 Sun)Track maintenance,)track renewal,)repairs to platform)awnings (Chelmsford)Station) and)overhead line work.)Mechanical)equipment in use.)Possession to be)given up for)passage of 1Y02)02 20 Liverpool)Street to)Stowmarket over)Up Main line under)single line)working.
93	New Hall G.F. and Witham	Up BLOCKED Down BLOCKED	23 15 Sat to 15 15 00 10 to 13 30 Sun)Track maintenance,)track renewal,)formation renewal,)drainage and)overhead line work.)Mechanical)equipment in use.)00 10 to 13 30 Sun.)Possession to be)given up for 1Y02)02 20 Liverpool)Street to)Stowmarket)over Down line.)13 30 to 15 15)Sun Single line)working over)Down line.
SUNDAY 23 NOVEMBER				
94	Gidea Park	Down Electric	08 00 to 16 00.	Signalling work (No. 43A points).
95	Shenfield and Witham	All BLOCKED to electric trains	00 10 to 13 30.	In connection with engineering work. <u>Isolation of electrical sections 333, 334, 335 and 336.</u>

SECTION B - TEMPORARY ENGINEERING WORKS - continued

At or between	Lines affected	Remarks
<u>LIVERPOOL STREET TO NORWICH - continued</u>		
SUNDAY 23 NOVEMBER - continued		
96 Colchester (Country End) and Manningtree North Jn	All BLOCKED to electric trains	00 35 to 06 00. In connection with engineering work between Manningtree Station and Manningtree North Jn. <u>Isolation of electrical sections 341 and 342.</u>
97 Manningtree Station and Manningtree North Jn.	Down and Up BLOCKED	00 35 to 16 00. Level crossing road repairs (Manningtree South Jn LC). Crane and mechanical equipment in use. <u>00 35 to 06 00 Possession to be given up for passage of 1Y02 02 20 Liverpool Street to Stowmarket over Down line. 06 00 to 16 00 Possession to be given up for passage of trains.</u>
98 Trowse Lower Jn and Norwich Station	All	07 00 to 18 00. Signalling work. Points and signals disconnected.

SUNDAY/MONDAY 23/24 NOVEMBER

99 Liverpool Street Station	Platforms 11 to 18 inc. BLOCKED to electric trains	13 30 to 02 30. In connection with engineering work. <u>Isolation of electrical sections 301BCDE, 302ABCD, 304ABCDEF.</u> <u>13 30 to 14 30 Sun Electric trains to be replatformed as necessary. 14 30 to 23 59 Sun Diesel trains to travel to/from Platform 11. Electric trains to be replatformed as necessary. 23 59 Sun to 02 30 Electric trains to be replatformed as necessary.</u>
100 Liverpool Street Station	Platforms 16 and 17 BLOCKED	13 30 to 02 30. Construction work. Mechanical equipment in use. <u>Trains to be replatformed as necessary.</u>

SUNDAY 23 TO THURSDAY 27 NOVEMBER

101 Thorpe Jn and Norwich	'C' and 'W' lines <u>Between Trains</u>)23 30 Sun to Wed to 05 00 Mon to Thu.)Construction work (overhead line).))
Norwich Station	Platforms 1, 2 and 3 <u>Between Trains</u>))))

SECTION B - TEMPORARY ENGINEERING WORKS - continued

At or between	Lines affected	Remarks
<u>LIVERPOOL STREET TO NORWICH - continued</u>		
SUNDAY 23 TO FRIDAY 28 NOVEMBER		
102 Norwich and Whitlingham Jn	'A' and 'E' lines/Down and Up Lowestoft/ Main BLOCKED)23 30 Sun to Thu to 05 00 Mon to Fri.)Construction work (overhead line).) <u>Possession to be given up for passage</u>) <u>of trains.</u>))
Norwich Station	Platforms 4, 5 and 6 BLOCKED)))

MONDAY 24 NOVEMBER

103 Chadwell Heath Jn and Shenfield (London End. Jn)	Down and Up Electric BLOCKED	01 00 to 05 00. Overhead line work. <u>Isolation of electrical sections 325A,</u> <u>326F, 329F, 330A. Possession to be</u> <u>given up for passage of 1K12 03 35</u> <u>Liverpool Street to Southend Victoria</u> <u>(diesel hauled) over Down Electric</u> <u>line. Other trains to travel over</u> <u>Main lines. Local services between</u> <u>Chadwell Heath and Gidea Park</u> <u>Station/Sidings NOT affected.</u>
104 Colchester (Country End) and East Suffolk Jn	All BLOCKED to electric trains	01 30 to 04 00. In connection with overhead line work. <u>Isolation of</u> <u>electrical sections 341, 342, 343 and</u> <u>344.</u>
105 Manningtree South Jn and Manningtree North Jn	Down and Up BLOCKED	01 30 to 04 00. Overhead line work. <u>Possession to be given up for passage</u> <u>of Diesel trains.</u>

MONDAY 24 TO FRIDAY 28 NOVEMBER

106 Liverpool Street Station	Platform 10 BLOCKED	10 40 to 15 40 daily. Construction work. Mechanical equipment in use. <u>Isolation of electrical sections 305H.</u> <u>Trains to be replatformed as</u> <u>necessary.</u>
---------------------------------	------------------------	---

SECTION B - TEMPORARY ENGINEERING WORKS - continued

<u>At or between</u>	<u>Lines affected</u>	<u>Remarks</u>
----------------------	-----------------------	----------------

LIVERPOOL STREET TO NORWICH - continued

MONDAY 24 TO FRIDAY 28 NOVEMBER - continued

107	Liverpool Street Station	Platforms 16 and 17 BLOCKED	23 50 Mon to Thu to 05 00 Tue to Fri. Construction work. Mechanical equipment in use. <u>Isolation of electrical sections 301D, 302B.</u> <u>Trains to be replatformed as necessary.</u>
108	Bethnal Green and Stratford (London End)	Down and Up Electric BLOCKED	23 00 Mon to Thu to 05 00 Tue to Fri. Overhead line work. Mechanical equipment in use. <u>Isolation of electrical sections 309A, 310B.</u> <u>Trains to travel over Main lines.</u>
109	Gidea Park Jn and Shenfield (London End Jn)	Down and Up Main BLOCKED	21 15 Mon to Thu to 05 00 Tue to Fri. Track maintenance and undertrack excavation. Mechanical equipment in use. <u>Isolation of electrical sections 331D, 332A.</u> <u>Trains to travel over Electric lines.</u>
110	Diss and Flordon	Down BLOCKED	23 00 Mon to Thu to 04 30 Tue to Fri. Track maintenance and track renewal. Mechanical equipment in use. <u>Single line working over Up line.</u>
111	Trowse Lower Jn and Flordon	Up BLOCKED	22 00 Mon to Thu to 05 00 Tue to Fri. Track maintenance. Mechanical equipment in use. <u>Possession to be given up for passage of 1C03 23 35 Norwich to Liverpool Street.</u>
112	Swainsthorpe LC and Trowse Swing Bridge	All <u>Between Trains</u>	07 00 to 16 00 daily. Signalling work.

MONDAY 24 TO SATURDAY 29 NOVEMBER

113	Liverpool Street Station	Platforms 1, 2, 3 and 4 BLOCKED	23 00 Mon to Fri to 05 15 Tue to Sat. Repairs to station roof. <u>Isolation of electrical sections 306ABC.</u> <u>Trains to be replatformed as necessary.</u>
-----	--------------------------	------------------------------------	---

SECTION B - TEMPORARY ENGINEERING WORKS - continued

At or between	Lines affected	Remarks
<u>LIVERPOOL STREET TO NORWICH - continued</u>		
TUESDAY 25 AND WEDNESDAY 26 NOVEMBER		
114 Church Lane LC and Chelmsford	Down BLOCKED	00 10 to 05 00 daily. Track maintenance. 29% and 29% m.p. Mechanical equipment in use. <u>Single line working over Up line.</u>
THURSDAY/FRIDAY 27/28 NOVEMBER		
115 Thorpe Jn and Norwich	'C' and 'W' lines BLOCKED)23 30 to 05 00. Construction work (overhead line) and track maintenance. Mechanical equipment in use. <u>Possession to be given up for passage of trains.</u>
Norwich Station	Platforms 1, 2 and 3 BLOCKED))
FRIDAY 28 NOVEMBER		
116 Hill House G.F. and Kelvedon	Up BLOCKED	00 01 to 04 45. Track maintenance. Mechanical equipment in use. <u>Single line working over Down line.</u>
FRIDAY 28 NOVEMBER TO MONDAY 1 DECEMBER		
117 Bethnal Green and Bow Jn	Down and Up Electric BLOCKED)23 00 Fri to 05 00 Mon. Bridgework (No. 46), overhead line work and signalling work. Mechanical equipment in use. <u>Isolation of electrical sections 309A, 310B.</u>
Bethnal Green and Stratford (London End)	Down and Up Electric BLOCKED to electric trains)23 00 Fri to 00 15 Sat. <u>Trains to travel over Main lines.</u>)00 15 to 12 00 Sat Diesel trains to/from Stratford direction to travel over Down Main line under single line working between Liverpool Street and Bow Jn. <u>Trains to/from Hackney Downs direction to travel over Suburban lines between Liverpool Street and Bethnal Green (Country End).</u>)00 01 to 05 00 Mon <u>Trains to/from Stratford direction to travel over Down Main line under single line working between Liverpool Street and Bow Jn. Trains to/from Hackney Downs direction to travel over Suburban lines between Liverpool Street and Bethnal Green (Country end).</u>

SECTION B - TEMPORARY ENGINEERING WORKS - continued

At or between	Lines affected	Remarks
---------------	----------------	---------

CARPENTERS ROAD SOUTH JN TO CARPENTERS ROAD NORTH JN

MONDAY 24 NOVEMBER

118	Carpenters Road South Jn and Carpenters Road North Jn	Down and Up BLOCKED	07 45 to 09 45. Signalling work. Crane in use.
119	Carpenters Road South Jn and Carpenters Road North Jn	Down and Up BLOCKED	16 45 to 18 45. Signalling work. Crane in use.

NAVARINO ROAD JN TO NORTH WOOLWICH

UNTIL FURTHER NOTICE

120	Highbury and Homerton	All	07 30 to 18 00. Earthwork and construction work. Mechanical equipment in use. (86/1)
-----	-----------------------	-----	---

SUNDAY 23 NOVEMBER

121	Dalston Western Jn and Hackney Central	All BLOCKED to AC electric trains	00 01 to 08 00. In connection with engineering work between Dalston Western Jn and Lea Jn. <u>Isolation of electrical sections 314DEFJK.</u>
122	Dalston Western Jn and Lea Jn	All BLOCKED	00 01 to 08 00. Unloading materials and demolition work. Mechanical equipment in use. <u>Isolation of DC electrical sections 707, 708, 709B, 710A.</u>
123	Channelsea South Jn and North Woolwich	All BLOCKED	00 15 to 08 00. Bridgework (Nos. 618A and 619). 4m. 67chs. <u>Isolation of electrical sections 701, 702, 703, 704, 705AB, 706BC.</u>

SECTION B - TEMPORARY ENGINEERING WORKS - continued

At or between	Lines affected	Remarks
---------------	----------------	---------

CHANNELSEA SOUTH JN TO STRATFORD CENTRAL JN WEST

UNTIL FURTHER NOTICE

124	Channelsea South Jn and Stratford Central Jn West	Down and Up BLOCKED to electric trains	In connection with engineering work. (86/14)
-----	---	--	---

MONDAY 24 NOVEMBER

125	Carpenters Road North Jn and Stratford Central Jn West	Down and Up BLOCKED	07 45 to 09 45. Signalling work. Crane in use.
126	Carpenters Road North Jn and Stratford Central Jn West	Down and Up BLOCKED	16 45 to 18 45. Signalling work. Crane in use.

FOREST GATE JN TO WOODGRANGE PARK JN

SUNDAY 23 NOVEMBER

127	Forest Gate Jn and Barking Station (Country End)	All BLOCKED to electric trains	00 50 to 06 15. In connection with engineering work between Woodgrange Park Jn and Barking Tilbury Line Jn West. <u>Isolation of electrical sections 512 and 513.</u>
-----	--	--------------------------------------	---

SHENFIELD JN TO SOUTHEND VICTORIA

UNTIL FURTHER NOTICE

128	Billericay	Down and Up	07 30 to 17 30. Construction work and platform work. Mechanical equipment in use. (86/19)
129	Wickford Station	All	Platform work and earthwork. (85/63)

SECTION B - TEMPORARY ENGINEERING WORKS - continued

<u>At or between</u>	<u>Lines affected</u>	<u>Remarks</u>
----------------------	-----------------------	----------------

SHENFIELD JN TO SOUTHEND VICTORIA - continued

UNTIL FURTHER NOTICE - continued

130	Wickford Jn	All	08 00 to 17 00. Signalling work. (85/41)
131	Rayleigh and Hockley	Down	08 00 to 17 00. Earthwork 34½ and 34¾ m.p. Mechanical equipment in use. (85/61)
132	Southend Victoria Station	All	08 00 to 18 00. Repairs to station roof. (86/20)

WICKFORD JN TO SOUTHMINSTER

UNTIL FURTHER NOTICE

133	Wickford Jn	All	08 00 to 17 00. Signalling work. (85/41)
134	Fambridge Station	Single	07 30 to 18 00. Platform work. (85/55)
135	Burnham-on- Crouch	Single	07 30 to 18 00. Earthwork. 43m 24chs. (85/30)

SATURDAY 22 NOVEMBER

136	Wickford Jn and Southminster	Single BLOCKED	00 01 to 04 45. Unloading materials.
-----	------------------------------------	-------------------	--------------------------------------

SUNDAY 23 NOVEMBER

137	Wickford Jn and Southminster	Single BLOCKED	00 30 to 08 00. Track maintenance.
-----	------------------------------------	-------------------	------------------------------------

SECTION B - TEMPORARY ENGINEERING WORKS - continued

<u>At or between</u>	<u>Lines affected</u>	<u>Remarks</u>
----------------------	-----------------------	----------------

WITHAM TO BRAINTREE

UNTIL FURTHER NOTICE

138 Witham and Braintree	Single	07 00 to 18 00. Construction work (Bridge No. 2102B). (86/19)
--------------------------	--------	--

FRIDAY/SATURDAY 21/22 NOVEMBER

139 Witham and Braintree	Single BLOCKED	23 40 to 05 30. Bridgework (No.2102B). Mechanical equipment in use. <u>Isolation of electrical sections 379.</u>
--------------------------	-------------------	--

MONDAY 24 TO SATURDAY 29 NOVEMBER

140 Witham and Braintree	Single BLOCKED	23 40 Mon to Fri to 05 30 Tue to Sat. Bridgework (No.2102B). Mechanical equipment in use. <u>Isolation of electrical sections 379.</u>
--------------------------	-------------------	--

MARKS TEY TO SUDBURY

MONDAY 24 TO FRIDAY 28 NOVEMBER

141 Marks Tey Jn and Sudbury	Single BLOCKED	22 15 Mon to Thu to 05 15 Tue to Fri. Trimming lineside vegetation. Mechanical equipment in use.
------------------------------	-------------------	--

COLCHESTER TO CLACTON

SUNDAY 23 NOVEMBER

142 Hythe Station and Thorpe-le-Soken	Down and Up BLOCKED	00 10 to 07 30. Loading rails. Mechanical equipment in use.
---------------------------------------	------------------------	---

THORPE-LE-SOKEN TO WALTON-ON-NAZE

MONDAY 24 TO SATURDAY 29 NOVEMBER

143 Thorpe-le-Soken and Walton-on-Naze	Single BLOCKED	23 59 Mon to Fri to 05 00 Tue to Sat. Overhead line work. Mechanical equipment in use. <u>Isolation of electrical sections 387.</u>
--	-------------------	---

SECTION B - TEMPORARY ENGINEERING WORKS - continued

At or between	Lines affected	Remarks
---------------	----------------	---------

MANNINGTREE SOUTH JN TO HARWICH

UNTIL FURTHER NOTICE

144	Wrabness and Mistley	Up	07 30 to 17 00. Earthwork. 64m. 46chs. and 64m. 15chs. Mechanical equipment in use. (85/65)
-----	----------------------	----	--

SATURDAY/SUNDAY 22/23 NOVEMBER

145	Manningtree South Jn and Harwich Town	All BLOCKED to electric trains	23 30 to 06 30. In connection with engineering work. <u>Isolation of electrical sections 391 and 392.</u>
146	Manningtree East Jn and Wrabness	Down and Up BLOCKED	23 30 to 07 00. Track renewal and unloading rails. 61 and 63 $\frac{1}{2}$ m.p. Mechanical equipment in use.
147	Wrabness and Harwich Parkeston Quay	All BLOCKED	23 30 to 06 30. Trimming lineside vegetation and overhead line work. Mechanical equipment in use.
148	Harwich Parkeston Quay and Harwich Town	All BLOCKED	23 20 to 16 00. Level crossing road repairs (Alexandra Road LC), trimming lineside vegetation and overhead line work. Crane and mechanical equipment in use. <u>Possession to be given up for passage of local trip trains.</u> <u>06 30 to 16 00 Sun Isolation of electrical sections 391A, 392G.</u>

MONDAY 24 NOVEMBER

149	Manningtree South Jn and Harwich Town	All BLOCKED to electric trains	01 30 to 04 00. In connection with overhead line work. <u>Isolation of electrical sections 391 and 392.</u>
-----	---------------------------------------	--------------------------------	---

MONDAY 24 TO WEDNESDAY 26 NOVEMBER

150	Parkeston Goods Jn and Wrabness	Up BLOCKED	23 00 Mon and Tue to 04 45 Tue and Wed. Track maintenance. Mechanical equipment in use. <u>Single line working over Down line.</u>
-----	---------------------------------	------------	--

SECTION B - TEMPORARY ENGINEERING WORKS - continued

At or between	Lines affected	Remarks
---------------	----------------	---------

MANNINGTREE EAST JN. TO NORTH JN.

MONDAY 24 NOVEMBER

151	Manningtree East Jn and Manningtree North Jn	Single BLOCKED	01 30 to 04 00. Overhead line work. <u>Isolation of electrical sections 343 and 392. Possession to be given up for passage of 5F56 01 55 Ipswich to Harwich Parkeston Quay (Diesel hauled).</u>
-----	---	-------------------	--

EAST SUFFOLK JN TO OULTON BROAD NORTH JN

UNTIL FURTHER NOTICE

152	Westerfield Jn and Woodbridge	Down and Up BLOCKED	07 00 to 19 00. Bridgework (No.418A). 76m. 65chs. Mechanical equipment in use. <u>Possession to be given up for passage of trains.</u> (86/33)
-----	----------------------------------	------------------------	---

SATURDAY/SUNDAY 22/23 NOVEMBER

153	Westerfield and Woodbridge	Down BLOCKED Up BLOCKED	23 10 to 10 30)Track renewal and)track maintenance. 23 10 to 17 00)Crane and mechanical)equipment in use.) <u>10 30 to 17 00</u>) <u>Sun. Single line</u>) <u>working over Down</u>) <u>line.</u>
154	Woodbridge and Saxmundham	Single BLOCKED	23 00 to 07 00. Trimming lineside vegetation. 80% and 8lm.p. Mechanical equipment in use.

WESTERFIELD JN TO FELIXSTOWE

UNTIL FURTHER NOTICE

155	Westerfield Jn and Derby Road	Single	08 00 to 16 00. Earthwork. 73m. 13chs. and 73 $\frac{1}{2}$ m.p. (85/61)
156	Derby Road and Felixstowe Beach Jn	Single	07 30 to 17 00. Earthwork. 82% and 83m.p. Mechanical equipment in use. (86/1)

SECTION B - TEMPORARY ENGINEERING WORKS - continued

At or between	Lines affected	Remarks
<u>WESTERFIELD JN TO FELIXSTOWE - continued</u>		
SATURDAY/SUNDAY 22/23 NOVEMBER		
157 Westerfield Jn and Derby Road	Single BLOCKED	23 00 to 07 00. Track maintenance. Mechanical equipment in use.
158 Derby Road and Felixstowe Beach Jn	Single BLOCKED	22 00 to 18 00. Track maintenance, track renewal and loading rails. Crane and mechanical equipment in use.
<u>NORWICH TO LOWESTOFT</u>		
UNTIL FURTHER NOTICE		
159 Norwich Station and Trowse Lower Jn	All <u>Between Trains</u>	07 00 to 17 00. Construction work (overhead line), earthwork, track maintenance and signalling work. Points and signals disconnected. (86/7)
SATURDAY/SUNDAY 22/23 NOVEMBER		
160 Trowse Swing Bridge and Norwich Station	'C' line/Up Main BLOCKED Down Main/'W' line BLOCKED	23 00 to 06 45)Construction work) (overhead line) 23 59 to 07 00) and loading materials.) <u>Possession to be given</u>) <u>given up for passage of</u>) <u>1P04 02 10 Liverpool</u>) <u>Street to Yarmouth.</u>
161 Norwich and Whitlingham Jn	'A' and 'E' lines/Down and Up Lowestoft/ Main BLOCKED) 23 15 to 07 00. Construction work) (overhead line) and loading) materials. <u>Possession to be given</u>) <u>up for passage of trains.</u>))
Norwich Station	Platforms 1, 2 and 3 (and approaches) and Platforms 4, 5 and 6 BLOCKED))))))))

SECTION B - TEMPORARY ENGINEERING WORKS - continued

At or between	Lines affected	Remarks
---------------	----------------	---------

NORWICH TO LOWESTOFT - continued

SATURDAY/SUNDAY 22/23 NOVEMBER - continued

162	Whitlingham Jn and Cantley	Down and Up BLOCKED	23 30 to 08 00. Track maintenance, and loading rails. Crane and mechanical equipment in use. <u>Possession to be given up for passage of 1P04 02 10 Liverpool Street to Yarmouth and 1B02 05 39 Norwich to Lowestoft over Down line</u>
-----	----------------------------------	------------------------	--

SUNDAY 23 NOVEMBER

163	Trowse Lower Jn All and Norwich Station		07 00 to 18 00. Signalling work. Points and signals disconnected
-----	---	--	---

SUNDAY 23 TO THURSDAY 27 NOVEMBER

164	Thorpe Jn and Norwich	'C' and 'W' lines <u>Between Trains</u>)23 30 Sun to Wed to 05 00 Mon to Thu.)Construction work (overhead line).))
	Norwich Station	Platforms 1, 2 and 3 <u>Between Trains</u>))))

SUNDAY 23 TO FRIDAY 28 NOVEMBER

165	Norwich and Whitlingham Jn	'A' and 'E' lines/Down and Up Lowestoft/ Main BLOCKED)23 30 Sun to Thu to 05 00 Mon to Fri.)Construction work (overhead line).) <u>Possession to be given up for passage of trains.</u>))
	Norwich Station	Platforms 4, 5 and 6 BLOCKED))))

SECTION B - TEMPORARY ENGINEERING WORKS - continued

At or between	Lines affected	Remarks
<u>NORWICH TO LOWESTOFT - continued</u>		
TUESDAY 25 TO FRIDAY 28 NOVEMBER		
166 Cantley and Reedham Jn	Down and Up BLOCKED	23 30 Tue to Thu to 05 15 Wed to Fri. Track maintenance. Mechanical equipment in use.

THURSDAY/FRIDAY 27/28 NOVEMBER

167 Thorpe Jn and Norwich	'C' and 'W' lines BLOCKED)23 30 to 05 00. Construction work) (overhead line) and track) maintenance. Mechanical equipment) in use. <u>Possession to be given up</u>) <u>for passage of trains.</u>)))
Norwich Station Platforms 1, 2, and 3	BLOCKED	

WHITLINGHAM JN TO CROMER

UNTIL FURTHER NOTICE

168 Whitlingham Jn and Wroxham	Down and Up	07 30 to 16 30. Bridgework (No. 365). 3m. 48chs. (86/6)
169 Cromer Station	Platforms 1 and 2	Platform work. (86/15)

CROMER TO SHERINGHAM

UNTIL FURTHER NOTICE

170 Cromer Station	Platforms 1 and 2	Platform work. (86/15)
--------------------	-------------------	---------------------------

BRUNDALL JN TO YARMOUTH VIA ACLE

UNTIL FURTHER NOTICE

171 Brundall Jn and Yarmouth	All	08 00 to 16 00. Signalling work. (86/30)
------------------------------	-----	---

SECTION B - TEMPORARY ENGINEERING WORKS - continued

At or between	Lines affected	Remarks
<u>REEDHAM JN TO YARMOUTH</u>		
UNTIL FURTHER NOTICE		
172 Reedham Jn and Yarmouth	All	08 00 to 16 00. Signalling work. (86/30)
MONDAY/TUESDAY 24/25 NOVEMBER		
173 Reedham Jn and Yarmouth	Single BLOCKED	23 45 to 05 30. Unloading materials.
<u>BETHNAL GREEN JN TO KING'S LYNN</u>		
UNTIL FURTHER NOTICE		
174 Cambridge Heath Station	Down and Up Suburban	08 00 to 17 00. Platform work. 1m. 61chs. Mechanical equipment in use. (<u>See Section 'D'</u>). (86/24)
175 London Fields Station	Down and Up Suburban	Platform work. 2m. 35chs. Mechanical equipment in use. (<u>See Section 'D'</u>). (86/27)
176 Enfield Lock Station	Up	08 00 to 16 30. Platform work. 11m. 65chs. Mechanical equipment in use. (86/28)
177 Enfield Lock and Waltham Cross	Down and Up	07 00 to 18 00. Bridgework (No.1418C). 12m. 34chs. Crane and mechanical equipment in use. (85/59)
178 Bishops Stortford (Country end) and Stansted	Down and Up Main BLOCKED to electric trains	Overhead line work. <u>Isolation of electrical sections 427, 428 (buffer section)</u> . (85/41)
179 Bishops Stortford and Cambridge (North)	All	07 00 to 18 00. Construction work (overhead line). Mechanical equipment in use. (85/21)
180 Whittlesford Station	Down and Up	Platform work. 49m. 02chs. Mechanical equipment in use. (86/29)
181 Chesterton Jn and Milton Fen LC	Down and Up	07 30 to 18 00. Bridgework (No. 1550B). 58m. 63chs. Mechanical equipment in use. (86/24)

SECTION B - TEMPORARY ENGINEERING WORKS - continued

At or between	Lines affected	Remarks
<u>BETHNAL GREEN JN TO KING'S LYNN - continued</u>		
SATURDAY 22 NOVEMBER		
182 Clapton Jn and Cheshunt Jn	Down and Up Main BLOCKED to electric trains	00 01 to 04 30. In connection with engineering work between Brimsdown and Cheshunt Jn. <u>Isolation of electrical sections 411 and 412.</u> <u>Electric trains diverted via Southbury.</u>
183 Brimsdown and Cheshunt Jn	Down and Up BLOCKED	00 01 to 04 30. Overhead line work and bridgework (No.1418C). Mechanical equipment in use. <u>Possession to be given up for passage of Diesel trains. Electric trains diverted via Southbury.</u>
184 Coldham Lane Jn and Waterbeach	All <u>Between Trains</u>	07 00 to 16 00. Bridgework (Nos.1547, 1548, 1548A, 1549 and 1550A).
SATURDAY/SUNDAY 22/23 NOVEMBER		
185 Spelbrook and Harlow Mill	Up BLOCKED	23 30 to 06 00. Track maintenance. 28m. 15chs. and 26m. 55chs.
186 Bishops Stortford and Audley End	Up Main BLOCKED Down Main BLOCKED	22 30 to 08 30)Construction work) (overhead line). 30% 23 50 to 09 00)and 41½m.p. Mechanical)equipment in use.) <u>Possession to be</u>) <u>given up for passage</u>) <u>of 1P04 02 10 Liverpool</u>) <u>Street to Yarmouth and</u>) <u>1H02 03 10 Liverpool</u>) <u>Street to King's Lynn</u>) <u>over Down Main line.</u>
187 Shepreth Branch Jn and Coldham Lane Jn	All <u>Between Trains</u>	22 00 to 08 00. Construction work. (overhead line). 53% and 56½m.p. Mechanical equipment in use.

SECTION B - TEMPORARY ENGINEERING WORKS - continued

At or between	Lines affected	Remarks
---------------	----------------	---------

BETHNAL GREEN JN TO KING'S LYNN - continued

SATURDAY/SUNDAY 22/23 AND SUNDAY 23 NOVEMBER

188	Whittlesford Crossovers and Shepreth Branch Jn	Up BLOCKED Down BLOCKED	22 20 Sat to 08 15) 00 05 to 09 00 Sun)	Construction work (overhead line). 49½ and 53½m.p. Mechanical equipment in use. Possession to be given up for passage of 1P04 02 10 Liverpool Street to Yarmouth and 1H02 03 10 Liverpool Street to King's Lynn over Down line.
-----	---	----------------------------------	--	---

SUNDAY 23 NOVEMBER

189	Copper Mill North Jn and Cheshunt Jn	Down and Up Main BLOCKED	00 01 to 06 15.	Track maintenance. 9% and 10½m.p. Mechanical equipment in use. <u>Trains diverted via Southbury.</u>
190	Spelbrook and Bishops Stortford (Country End)	All BLOCKED	00 30 to 06 15.	Overhead line work. Mechanical equipment in use. <u>Isolation of electrical sections 417 and 418. Possession to be given up for passage of 1P04 02 10 Liverpool Street to Yarmouth and 1H02 03 10 Liverpool Street to King's Lynn over Down Main line.</u>
191	Audley End and Great Chesterford	Down and Up BLOCKED	00 01 to 08 00.	Trimming lineside vegetation. 42 and 43½m.p. Mechanical equipment in use. <u>Possession to be given up for passage of 1P04 02 10 Liverpool Street to Yarmouth and 1H02 03 10 Liverpool Street to King's Lynn over Down line.</u>

SECTION B - TEMPORARY ENGINEERING WORKS - continued

At or between	Lines affected	Remarks
BETHNAL GREEN JN TO KING'S LYNN - continued		
SUNDAY 23 NOVEMBER - continued		
192 Great Chesterford and Whittlesford Crossovers	Down Main BLOCKED Up Main BLOCKED	00 10 to 08 15)Track maintenance and platform work 00 10 to 16 00)(Whittlesford Station). 46m.p. and 49m. 02chs. Mechanical equipment in use. <u>00 10 to 08 15</u> <u>Possession to be given</u> <u>up for passage of 1P04</u> <u>02 10 Liverpool Street</u> <u>to Yarmouth and 1H02</u> <u>03 10 Liverpool Street</u> <u>to King's Lynn over</u> <u>Down Main line.</u> <u>08 15 to 16 00.</u> <u>Single line working</u> <u>over Down Main</u> <u>line.</u>

SUNDAY/MONDAY 23/24 NOVEMBER

193 Shepreth Branch Jn and Cambridge (South)	Down Main and Down Goods Loop South BLOCKED	23 00 to 05 30. Construction work (overhead line). 53% and 55% m.p. Mechanical equipment in use. <u>Single line working over Up Main line.</u>
194 Cambridge (South) and Coldham Lane Jn	All <u>Between trains</u>	23 00 to 05 30. Construction work (overhead line). 55% and 56% m.p. Mechanical equipment in use.

MONDAY 24 NOVEMBER

195 Bethnal Green and Cheshunt Jn.	Down and Up Fast/ Down and Up BLOCKED to electric trains	00 55 to 03 30. In connection with overhead line work between Clapton Jn and Copper Mill North Jn. <u>Isolation of electrical sections 407, 408, 411 and 412. Electric trains to travel over Suburban lines.</u>
196 Clapton Jn and Copper Mill North Jn	Down and Up BLOCKED	00 55 to 03 30. Overhead line work.

SECTION B - TEMPORARY ENGINEERING WORKS - continued

At or between	Lines affected	Remarks
---------------	----------------	---------

BETHNAL GREEN JN TO KING'S LYNN - continued

MONDAY/TUESDAY 24/25 NOVEMBER

197	Elsenham and Audley End	Down BLOCKED	22 35 to 05 00. Track maintenance. 36 and 41½m.p. Mechanical equipment in use. <u>Single line working over Up line.</u>
-----	-------------------------	-----------------	---

MONDAY 24 AND TUESDAY 25 NOVEMBER

198	Elsenham and Audley End	Down BLOCKED	09 25 to 15 20 daily. Construction work (overhead line). 35½ and 41½m.p. <u>Single line working over Up line.</u>
-----	-------------------------	-----------------	---

MONDAY 24 TO WEDNESDAY 26 NOVEMBER

199	Spelbrook and Harlow Mill	Up BLOCKED	22 55 Mon and Tue to 05 20 Tue and Wed. Track maintenance and loading materials. Mechanical equipment in use. <u>Single line working over Down line.</u>
200	Audley End and Newport	Up	08 00 to 16 00 daily. Trimming lineside vegetation. 41½ and 40m.p.

MONDAY 24 TO FRIDAY 28 NOVEMBER

201	Shepreth Branch Jn and Coldham Lane Jn	All <u>Between Trains</u>	08 00 to 16 00 daily. Construction work (overhead line). 53½ and 56½m.p. Mechanical equipment in use.
202	Shepreth Branch Jn and Coldham Lane Jn	All <u>Between Trains</u>	23 30 Mon to Thu to 06 00 Tue to Fri. Construction work (overhead line). 53½ and 56½m.p. Mechanical equipment in use.

TUESDAY 25 TO FRIDAY 28 NOVEMBER

202A	Clapton Jn and Cheshunt Jn	Down and Up Main BLOCKED to electric trains	00 01 to 04 30 daily. In connection with engineering work between Tottenham South Jn and Cheshunt Jn. <u>Isolation of electrical sections 411 and 412. Electric trains diverted via Southbury.</u>
------	----------------------------	---	--

SECTION B - TEMPORARY ENGINEERING WORKS - continued

At or between	Lines affected	Remarks
<u>BETHNAL GREEN JN TO KING'S LYNN - continued</u>		
TUESDAY 25 TO FRIDAY 28 NOVEMBER - continued		
203 Tottenham South Jn and Cheshunt Jn	Down and Up Main BLOCKED	00 01 to 04 30 daily. Overhead line work and bridgework (No.1418C). Mechanical equipment in use. <u>Possession to be given up for passage of Diesel trains. Electric trains diverted via Southbury.</u>
WEDNESDAY/THURSDAY 26/27 NOVEMBER		
204 Whittlesford Crossovers and Great Chesterford	Up Main BLOCKED	22 35 to 04 00. Track maintenance. 46% and 46m.p. Mechanical equipment in use. <u>Single line working over Down Main line.</u>
WEDNESDAY 26 TO FRIDAY 28 NOVEMBER		
205 Spelbrook and Bishops Stortford	Down Main BLOCKED	23 20 Wed and Thu to 04 45 Thu and Fri. Track maintenance and unloading materials. Mechanical equipment in use. <u>Single line working over Up Main line.</u>
206 Newport and Elsenham	Up	08 00 to 16 00 daily. Trimming lineside vegetation. 39% and 35% m.p.
207 Audley End and Elsenham	Up BLOCKED	09 20 to 15 50 daily. Construction work (overhead line). 41% and 35% m.p. <u>Single line working over Down line.</u>
THURSDAY/FRIDAY 27/28 NOVEMBER		
208 Audley End and Elsenham	Up BLOCKED	22 35 to 05 00. Track maintenance. 41% and 36m.p. Mechanical equipment in use. <u>Single line working over Down line.</u>
<u>READING LANE JN TO NAVARINO ROAD JN (GRAHAM ROAD CURVE)</u>		
SUNDAY 23 NOVEMBER		
209 Reading Lane Jn and Navarino Road Jn	Single BLOCKED to electric trains	00 01 to 08 00. In connection with engineering work between Dalston Western Jn and Lea Jn. <u>Isolation of electrical sections 314C.</u>

SECTION B - TEMPORARY ENGINEERING WORKS - continued

At or between	Lines affected	Remarks
---------------	----------------	---------

HACKNEY DOWNS NORTH JN. TO ENFIELD TOWN

SUNDAY 23 NOVEMBER

- | | | | |
|-----|--|------------------------|--|
| 210 | Hackney Downs
North Jn and
Seven Sisters | Down and Up
BLOCKED | 00 30 to 06 00. Track maintenance.
3m. 41chs. and 3m. 67chs.
<u>Possession to be given up for passage
of 1P04 02 10 Liverpool Street to
Yarmouth (diverted), 1H02 03 10
Liverpool Street to King's Lynn
(diverted) and 1H04 04 00 Liverpool
Street to Harlow Town (diverted) over
Down line.</u> |
| 211 | Seven Sisters
and Enfield
Town | Down and Up
BLOCKED | 08 10 to 16 05. Loading and unloading
rails and overhead line work. Crane
and mechanical equipment in use.
<u>Isolation of electrical sections
401AB, 402DEF, 403 and 404. Trains
diverted via Clapton.</u> |

CLAPTON JN TO CHINGFORD

MONDAY 24 NOVEMBER

- | | | | |
|-----|-----------------------------|--|--|
| 212 | Clapton Jn and
Chingford | Down and Up
BLOCKED to
electric trains | 00 55 to 03 30. In connection with
overhead line work between Clapton Jn.
and Copper Mill North Jn. <u>Isolation
of electrical sections 409 and 410.</u> |
|-----|-----------------------------|--|--|

BROXBOURNE JN TO HERTFORD EAST

UNTIL FURTHER NOTICE

- | | | | |
|-----|--------------------------------|-------------|---|
| 213 | Rye House and
St. Margarets | Down and Up | 08 00 to 18 00. Bridgework
(No. 2035A). 19m. 66chs. Mechanical
equipment in use.

(85/60) |
|-----|--------------------------------|-------------|---|

SUNDAY 23 NOVEMBER

- | | | | |
|-----|---------------------------------------|----------------|---|
| 214 | Broxbourne Jn
and
Hertford East | All
BLOCKED | 00 30 to 06 30. Platform work and
construction work (St. Margarets
Station), track renewal and
bridgework (No. 2035A). Crane and
mechanical equipment in use.
<u>Isolation of electrical sections 434
and 435.</u> |
|-----|---------------------------------------|----------------|---|

SECTION B - TEMPORARY ENGINEERING WORKS - continued

At or between	Lines affected	Remarks
---------------	----------------	---------

BROXBOURNE JN TO HERTFORD EAST - continued

TUESDAY 25 TO FRIDAY 28 NOVEMBER

215	Broxbourne Jn ' and Hertford East	All BLOCKED	00 35 to 04 50 daily. Platform work and construction work (St. Margarets Station). Mechanical equipment in use.
-----	---	----------------	---

COLDHAM LANE JN TO HAUGHLEY JN

UNTIL FURTHER NOTICE

216	Bury St. Edmunds Station	Down	08 00 to 15 00. Repairs to platform awnings. (86/18)
-----	-----------------------------	------	---

SATURDAY/SUNDAY 22/23 NOVEMBER

217	Bury St. Edmunds and Haughley Jn	Down and Up BLOCKED	23 15 to 08 00. Track maintenance and track renewal. Mechanical equipment in use.
218	Haughley Jn	All BLOCKED	23 35 to 07 30. Track maintenance. Mechanical equipment in use.

SUNDAY 23 NOVEMBER

219	Dullingham and Chippenham Jn	Single BLOCKED	09 00 to 14 00. Tunnelwork (Warren Hill Tunnel). 14m. 3lchs. and 15m.p.
-----	------------------------------------	-------------------	---

MONDAY/TUESDAY 24/25 NOVEMBER

220	Kennett and Bury St. Edmunds	Down BLOCKED	23 00 to 05 30. Track maintenance. Mechanical equipment in use. <u>Single line working over Up line.</u>
-----	------------------------------------	-----------------	--

MONDAY 24 TO FRIDAY 28 NOVEMBER

221	Dullingham and Chippenham Jn	Single	08 00 to 16 00 daily. Trimming lineside vegetation. 11½ and 12½m.p. Mechanical equipment in use.
-----	------------------------------------	--------	--

SECTION B - TEMPORARY ENGINEERING WORKS - continued

At or between	Lines affected	Remarks
---------------	----------------	---------

COLDHAM LANE JN TO HAUGHLEY JN - continued

WEDNESDAY/THURSDAY 26/27 NOVEMBER

222 Bury St. Edmunds and Kennett	Up BLOCKED	23 00 to 05 30. Track maintenance. Mechanical equipment in use. <u>Single line working over Down line.</u>
--	---------------	--

ELY NORTH JN TO PETERBOROUGH, CRESCENT JN

UNTIL FURTHER NOTICE

223 Black Bank and Crescent Jn	All	06 00 to 16 00. Signalling work. <u>From 06 00 Monday 24 November.</u> (86/35)
-----------------------------------	-----	--

SATURDAY 22 TO SUNDAY 23 NOVEMBER

224 Chettisham and Manea	Down BLOCKED Up BLOCKED	11 30 Sat to 18 00 Sun)Bridgework) (Nos. 1813 and 11 45 Sat to 14 00 Sun)1814) 78 and) 78½m.p. Crane) and mechanical) equipment in) use. <u>14 00</u>) <u>to 18 00 Sun.</u>) <u>Single line</u>) <u>working over</u>) <u>Up line.</u>
-----------------------------	----------------------------------	--

SATURDAY/SUNDAY 22/23 NOVEMBER

225 Manea and March South Jn	Down and Up BLOCKED	23 30 to 08 30. Track maintenance. 80 and 85½m.p. Mechanical equipment in use.
---------------------------------	------------------------	--

SUNDAY 23 NOVEMBER

226 March West Jn and Whittlesea	Down and Up Main	07 00 to 17 00. Signalling work.
-------------------------------------	------------------	----------------------------------

TUESDAY/WEDNESDAY 25/26 NOVEMBER

227 Manea and March South Jn	Down BLOCKED	23 20 to 04 30. Track maintenance. 80 and 85½m.p. Mechanical equipment in use. <u>Single line working over Up line.</u>
---------------------------------	-----------------	---

SECTION B - TEMPORARY ENGINEERING WORKS - continued

At or between	Lines affected	Remarks
---------------	----------------	---------

ELY NORTH JN TO PETERBOROUGH, CRESCENT JN - continued

THURSDAY 27 NOVEMBER

228	Manea and Chettisham	Up BLOCKED	00 01 to 05 00. Bridgework (Nos. 1813 and 1814). 78% and 78m.p. <u>Single line working over Down line.</u>
-----	----------------------	---------------	--

ELY NORTH JN TO TROWSE LOWER JN

UNTIL FURTHER NOTICE

229	Thetford and Lakenheath	Up	08 00 to 16 00. Track maintenance. 87% and 85% m.p. (86/24)
230	Wymondham and Hethersett	Down and Up <u>Between Trains</u>	07 30 to 18 00. Bridgework, earthwork and construction work. 115m. 65chs. and 117m. 69chs. Cranes and mechanical equipment in use. (86/18)
231	Wymondham and Trowse Lower Jn	Down and Up	07 30 to 16 00. Signalling work. (85/24)
232	Hethersett and Trowse Lower Jn	Down and Up	07 30 to 16 00. Bridgework (Nos. 1638, 1640, 1640A and 349). 121m. 17chs. and 122m. 32chs. (86/22)

SATURDAY/SUNDAY 22/23 AND SUNDAY 23 NOVEMBER

233	Wymondham and Trowse Lower Jn	Up BLOCKED Down BLOCKED Down and Up	21 30 Sat to 07 00) Bridgework) (Nos. 1640 and 23 55 Sat to 07 00) 1640A), track) maintenance and 07 00 to 16 00 Sun) track renewal.) Mechanical) equipment in use.) <u>Possession to be</u>) <u>given up for</u>) <u>passage of 1P04</u>) <u>02 10 Liverpool</u>) <u>Street to Yarmouth</u>) <u>over Down line.</u>
-----	-------------------------------	---	--

SECTION B - TEMPORARY ENGINEERING WORKS - continued

<u>At or between</u>	<u>Lines affected</u>	<u>Remarks</u>
----------------------	-----------------------	----------------

ELY NORTH JN TO TROWSE LOWER JN - continued

MONDAY/TUESDAY 24/25 NOVEMBER

234 Spooner Row and Wymondham	Down and Up BLOCKED	23 15 to 06 15. Track maintenance. Mechanical equipment in use.
-------------------------------	------------------------	---

MONDAY 24 TO WEDNESDAY 26 NOVEMBER

235 Lakenheath and Brandon	Down and Up BLOCKED	23 45 Mon and Tue to 05 45 Tue and Wed. Track maintenance. Mechanical equipment in use.
----------------------------	------------------------	---

MONDAY 24 TO FRIDAY 28 NOVEMBER

236 Wymondham and Hethersett	Down and Up BLOCKED	23 15 Mon to Thu to 06 00 Tue to Fri. Track maintenance. 116m. 08chs. and 116 $\frac{1}{2}$ m.p. Mechanical equipment in use.
------------------------------	------------------------	---

WEDNESDAY/THURSDAY 26/27 NOVEMBER

237 Thetford	Down and Up BLOCKED	23 45 to 06 00. Track maintenance. Mechanical equipment in use.
--------------	------------------------	---

WYMONDHAM TO NORTH ELMHAM

UNTIL FURTHER NOTICE

238 Wymondham and North Elmham	Single	08 00 to 16 00. Trimming lineside vegetation. $\frac{1}{4}$ and 6m.p. Mechanical equipment in use.
--------------------------------	--------	--

(85/31)

SUNDAY 23 NOVEMBER

239 Wymondham and North Elmham	Single BLOCKED	07 00 to 16 30. Bridgework.
--------------------------------	-------------------	-----------------------------

SECTION B - TEMPORARY ENGINEERING WORKS - continued

At or between	Lines affected	Remarks
<u>FENCHURCH STREET TO SHOEBURYNESS</u>		
UNTIL FURTHER NOTICE		
240 Fenchurch Street Station	All	Construction/demolition work. Mechanical equipment in use. (84/38)
241 Fenchurch Street and Stepney East	All	Construction work, and in connection with engineering work (Docklands Light Railway). Mechanical equipment in use. <u>(See Section 'D')</u> . (86/25)
242 Fenchurch Street and Gas Factory Jn	All	08 00 to 17 00. Signalling work. (86/1)
243 East Ham	Down and Up	Construction work. Mechanical equipment in use. (83/51)
244 East Ham and Barking (London End)	Down and Up	Erecting scaffolding in connection with bridge No. 66B. (85/8)
245 Leigh-on-Sea and Benfleet	Up	Sea wall work. (85/34)
246 Leigh-on-Sea	Down	09 00 to 16 00. Demolition work. Mechanical equipment in use. (85/60)
247 Westcliff-on-Sea	Down	09 00 to 16 00. Demolition work. Mechanical equipment in use. (85/60)
FRIDAY/SATURDAY 21/22 NOVEMBER		
248 Fenchurch Street Station	Platforms 1,2,3 and 4 BLOCKED	21 15 to 06 00. Construction work. Mechanical equipment in use.
249 Fenchurch Street and Gas Factory Jn	All BLOCKED	21 15 to 06 00. Repairs to platform awnings (Stepney East Station), construction work and painting Stepney East Station. <u>Isolation of electrical sections 501, 502, 503 and 504.</u>

SECTION B - TEMPORARY ENGINEERING WORKS - continued

At or between	Lines affected	Remarks
---------------	----------------	---------

FENCHURCH STREET TO SHOEBURYNESS - continued

FRIDAY/SATURDAY 21/22 NOVEMBER - continued

250	Upminster and Pitsea	Down and Up BLOCKED	23 50 to 04 25. Overhead line work and track maintenance. Mechanical equipment in use. <u>Isolation of electrical sections 517, 518, 519 and 520. Trains diverted via Grays.</u>
-----	----------------------	------------------------	--

SUNDAY 23 NOVEMBER

251	Gas Factory Jn and East Ham (London End)	Down and Up BLOCKED	01 00 to 22 00. Track renewal and track maintenance. Crane and mechanical equipment in use. <u>Isolation of electrical sections 505, 506, 507 and 508.</u>
252	Forest Gate Jn and Barking Station (Country End)	All BLOCKED to electric trains	00 50 to 06 15. In connection with engineering work between Woodgrange Park Jn and Barking Tilbury Lane Jn West. <u>Isolation of electrical sections 512 and 513.</u>

MONDAY 24 NOVEMBER

253	Barking and Upminster (Country End)	Down Main BLOCKED	01 00 to 04 15. Overhead line work. <u>Isolation of electrical sections 510E, 514. Down trains diverted via Grays.</u>
-----	-------------------------------------	----------------------	--

MONDAY 24 TO WEDNESDAY 26 NOVEMBER

254	Gas Factory Jn and East Ham (London End)	Down and Up BLOCKED	21 15 Mon and Tue to 06 15 Tue and Wed. Track maintenance. Mechanical equipment in use.
255	Leigh-on-Sea and Pitsea	Up BLOCKED	23 30 Mon and Tue to 04 30 Tue and Wed. Track maintenance. Mechanical equipment in use. <u>Single line working over Down line.</u>

SECTION B - TEMPORARY ENGINEERING WORKS - continued

<u>At or between</u>	<u>Lines affected</u>	<u>Remarks</u>
----------------------	-----------------------	----------------

FENCHURCH STREET TO SHOEBURYNESS - continued

MONDAY 24 TO SATURDAY 29 NOVEMBER

256 Fenchurch Street and Gas Factory Jn	All BLOCKED	21 15 Mon to Fri to 06 00 Tue to Sat. Repairs to platform awnings (Stepney East Station), construction work and painting Stepney East Station. <u>Isolation of electrical sections 501, 502, 503 and 504.</u>
---	----------------	---

TUESDAY 25 AND WEDNESDAY 26 NOVEMBER

257 Upminster and Laindon	Down and Up	11 00 to 14 00 daily. Unloading materials. 15% and 22 ³ / ₄ m.p.
---------------------------	-------------	--

TUESDAY 25 TO FRIDAY 28 NOVEMBER

258 Upminster and Pitsea	Down and Up BLOCKED	01 15 to 04 25 daily. Overhead line work. Mechanical equipment in use. <u>Isolation of electrical sections 517, 518, 519 and 520. Trains diverted via Grays.</u>
--------------------------	------------------------	--

WEDNESDAY 26 TO FRIDAY 28 NOVEMBER

259 Pitsea and Leigh-on-Sea	Down BLOCKED	23 30 Wed and Thu to 04 45 Thu and Fri. Track maintenance. Mechanical equipment in use. <u>Single line working over Up line.</u>
-----------------------------	-----------------	--

GAS FACTORY JN TO BOW JN

SUNDAY 23 NOVEMBER

260 Gas Factory Jn and Bow Jn	Single BLOCKED to electric trains	01 00 to 22 00. In connection with engineering work between Gas Factory Jn and East Ham. <u>Isolation of electrical sections 506A.</u>
-------------------------------	---	--

SECTION B - TEMPORARY ENGINEERING WORKS - continued

At or between	Lines affected	Remarks
---------------	----------------	---------

GAS FACTORY JN TO BOW JN - continued

FRIDAY 28 NOVEMBER TO MONDAY 1 DECEMBER

261	Gas Factory Jn and Bow Jn	Single BLOCKED	23 00 Fri to 05 00 Mon. In connection with engineering work. Mechanical equipment in use. <u>Isolation of electrical sections 309A.</u>
-----	---------------------------	-------------------	---

UPPER HOLLOWAY TO BARKING, TILBURY LINE JN WEST

UNTIL FURTHER NOTICE

262	Upper Holloway and Crouch Hill Station	Down and Up	Earthwork. 3m 41chs. and 3m 43chs. Mechanical equipment in use. (85/64)
263	Wanstead Park Station	Up	08 00 to 16 00. Platform work. <u>(See Section 'D')</u> . (85/50)
264	Woodgrange Park and Barking Station Jn	Down and Up <u>Between Trains</u>	07 30 to 18 00. Bridgework (No. 6). 12m. 26chs. Crane and mechanical equipment in use. (85/62)
265	Woodgrange Park and Barking Tilbury Line Jn West	Down and Up	Erecting scaffolding in connection with bridge No. 14A. (85/8)

SUNDAY 23 NOVEMBER

266	South Tottenham East Jn and Woodgrange Park Jn	Down and Up BLOCKED	08 00 to 16 00. Track maintenance. Mechanical equipment in use.
267	Forest Gate Jn and Barking Station (Country End)	All BLOCKED to electric trains	00 50 to 06 15. In connection with engineering work between Woodgrange Park Jn and Barking Tilbury Line Jn West. <u>Isolation of electrical sections 512 and 513.</u>
268	Woodgrange Park Jn and Barking Tilbury Line Jn West	Down and Up BLOCKED	00 50 to 06 15. Bridgework (No. 14A) and overhead line work. Crane and mechanical equipment in use. <u>Possession to be given up for passage of Engineers' trains.</u>

SECTION B - TEMPORARY ENGINEERING WORKS - continued

<u>At or between</u>	<u>Lines affected</u>	<u>Remarks</u>
----------------------	-----------------------	----------------

BARKING, TILBURY LINE JN EAST TO TILBURY RIVERSIDE

UNTIL FURTHER NOTICE

269	Dagenham Dock Station	Down and Up	08 00 to 17 00. Construction work. Mechanical equipment in use. (85/14)
270	Rainham Station	Down and Up	08 00 to 17 00. Construction work. Mechanical equipment in use. (85/14)
271	Purfleet Station	Down and Up	09 00 to 16 00. Platform work. Mechanical equipment in use. (85/61)

SUNDAY 23 NOVEMBER

272	Barking Tilbury Line Jn East and West Thurrock Jn	All BLOCKED	00 35 to 07 00. Track maintenance. Mechanical equipment in use.
-----	---	----------------	--

TILBURY RIVERSIDE TO PITSEA

SATURDAY/SUNDAY 22/23 NOVEMBER

273	Stanford-le-Hope and Pitsea	Down and Up BLOCKED	23 55 to 17 40. Reballasting, track maintenance, track renewal and overhead line work. Mechanical equipment in use. <u>Isolation of electrical sections 536CD, 537AB.</u>
-----	-----------------------------	------------------------	---

SECTION C

SIGNALLING AND PERMANENT WAY ALTERATIONS

* * Items marked thus will not appear in future issues and a note must be
* taken of them by all concerned.

DETAILS OF WORK REFERRED TO IN SECTION B

SUNDAY 23 NOVEMBER - TROWSE LOWER JUNCTION

The trailing connection Up Siding/Up Main nearest to the signalbox and on the Norwich side will be secured out of use pending removal.

The associated yellow faced disc shunting signal will be abolished.
(38)

DETAILS OF WORK ALREADY CARRIED OUT

NEW HALL

The Up Loop has been taken out of use Until Further Notice.
(UFN)

HATFIELD PEVEREL

The facing and trailing crossovers are out of use until further notice.
(UFN)

SWAINSTHORPE AUTOMATIC HALF-BARRIERS AT 109M. 54CHS.

When the road works are resumed, the crossing will be closed to road traffic and the barriers secured in the lowered position until such time as the work is completed.

(New Item) (UFN)

* * WOODHAM FERRERS AUTOMATIC OPEN LEVEL CROSSING AT 34M. 05CHS.

*

A Plunger (housed in a locked cabinet) has been provided attached to the post carrying the Down side Drivers flashing white light signal.

When the train is ready to depart and the Drivers white light is not illuminating, (providing the train is standing on the Down Platform line,), in order to reactivate the road traffic signals which may have extinguished on account of power failure or have been 'Timed-out', the Driver should unlock the cabinet by means of the Drivers No. 1 key and press the Plunger.

(35)

SECTION C - SIGNALLING AND PERMANENT WAY ALTERATIONS - continuedDETAILS OF WORK ALREADY CARRIED OUT - continuedBETWEEN HETHERSETT AND TROWSE LOWER JUNCTIONHethersett

The Down Main semaphore Starting Signal has been replaced by a 2-aspect (RED/GREEN) colour light signal plated HT13, 35 yards further from the signal box.

The Up Main Home 2-aspect colour light signal No. HTB has been repositioned 1,350 yards further from the signal box on a new right-hand bracket post.

The Up Main colour light Distant signal No. HTA (together with its associated A.W.S. track inductor) has been repositioned $1\frac{1}{4}$ miles further from the signal box to a position 2,037 yards before reaching the repositioned Up Home signal.

Reference should be made to the associated diagram included in this notice.

Level CrossingsIntwood Automatic Half-barrier Level Crossing at 119m. 47chs.Keswick Automatic Half Barrier Level Crossing at 120m.p.

The barriers at these crossings are equipped to work automatically when approached in the reverse direction and for this purpose, combined St. Andrew's Cross/30m.p.h. speed restriction signs have been provided applicable to each rail approach to the crossings in the wrong direction.

Eaton Minature Warning Lights Level Crossing at 120m. 29chs.

A combined St. Andrew's Cross/30m.p.h. speed restriction sign has been provided applicable to each wrong direction rail approach to Eaton Level Crossing.

A 'Whistle' board has been provided on each rail approach for normal and wrong direction of travel.

The distance of the St. Andrew's Cross/speed restriction signs and 'Whistle' boards from the three level crossings is as shown on the diagram.

(36)

AUDLEY END

3-aspect signal CA47, reading from the Up Main to Down Main at the north end of Audley End Up Platform, has been fitted with AWS equipment, 100 yards on the approach side of the signal.

(36)

SECTION C - SIGNALLING AND PERMANENT WAY ALTERATIONS - continued

DETAILS OF WORK ALREADY CARRIED OUT - continued

BETWEEN GAS FACTORY JN AND EAST HAM

The 60 m.p.h. Permanent Speed Restriction on the Down line between 2m. 73chs. and 6 $\frac{1}{2}$ m.p. has been withdrawn and the following Permanent Speed Restrictions now apply on the Down line:-

- 60 m.p.h. between 2m. 73chs. and 3m. 12chs.
- 70 m.p.h. between 3m. 12chs. and 6m.p.
- 60 m.p.h. between 6m.p. and 6 $\frac{1}{2}$ m.p.

(See Section 'D') (36)

SECTION C - SIGNALLING AND PERMANENT WAY ALTERATIONS - continued

DETAILS OF WORK ALREADY CARRIED OUT - continued

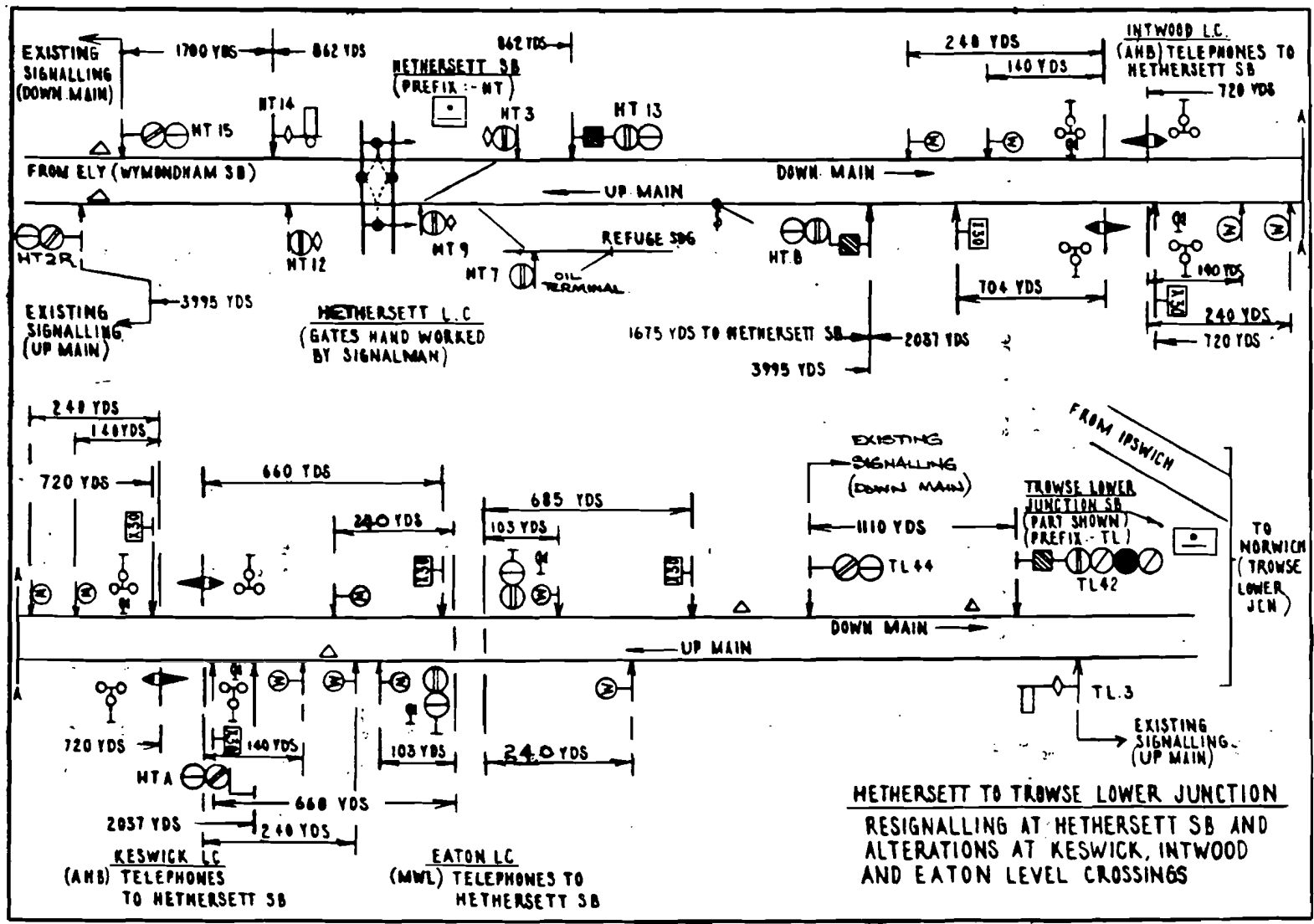

SECTION DGENERAL INSTRUCTIONS AND NOTICES

A thick vertical line denotes new or amended items.

* * Items marked thus will not appear in future issues and a note must be taken
* of them by all concerned.

WORKING MANUAL FOR RAIL STAFF
(B.R. 30054)

WHITE PAGES - PART 6Page C17

Warning - A -

Amend to read:- Wagon conveys dangerous goods ref. 2A - no more than one wagon or one 30' container permitted on Guardless train.

Page C18

Rejected - S -

Amend to read:- Wagon conveys dangerous goods not permitted on Guardless train.

Rejected - T -

Amend to read:- Warning - T - Wagon is of a type which may not be permitted on Guardless train.

Insert:- Warning - ? - Wagon has special handling code XLD refer to conditions of travel to check suitability for Guardless train.

Insert:- Rejected - . - Locomotive not equipped for Guardless train.

Amend:- Rejected - max. no. of D.I.T. locos. exceeded. See GA S2 Cl.1.5/1.7 to read:- GA S2 Pages 2.7-2.10.

Amend:- Rejected - D.I.T. Shunting loco. Must run Class 9. See GA S2 Cl. 1.5/1.7 to read:- GA S2 Pages 2.7-2.10.

Clause D5/2: Delete 2nd sentence.

Clause D5/3: Delete 1st sentence.

Insert "loaded and empty" between "both" and "conditions" in the existing 2nd sentence.

Clause D5/5: Amend "Clauses 12.10(b) and (c)" to read:- "Clauses 12.10.1(b) and (c)".

Clause D5/14: Amend speed of HAA (loaded) to 55.

Clause D9/6: Amend to read:-

It is essential that all handbrakes are fully released before a wagon is moved to prevent damage to the wheels.

SECTION D - GENERAL INSTRUCTIONS AND NOTICES - continued

WORKING MANUAL FOR RAIL STAFF - (B.R. 30054) - continued

WHITE PAGES - PART 6 - continued

Clause D9/6: - continued

Staff must ensure that they are fully aware of the correct method of hand-brake release as it does vary between individual wagon types as shown below:-

- (a) Clockwise to apply - anti-clockwise to release.
- (b) Anti-clockwise to apply - clockwise to release.
- (c) Separate hand-brakes on each bogie of a bogie wagon.
- (d) Both (a) and (b) can apply on a wagon depending on which side of the wagon the brakes are being released from (see D9/1).

After releasing the hand-brakes, wherever possible, staff must check by visual means that the brake has in fact been released by checking "indicators" where fitted, the brake rigging is slack and the hand-brake wheel will not turn any more.

The fact that the hand-brake wheel is slack is no positive indication that the brake has been released.

Clause D9/8: Delete.

(12.SD)

EASTERN REGION SECTIONAL (SOUTHERN APPENDIX AREA)

TABLE A : DETAILS OF RUNNING LINES

Running Lines and Signalling System	Location	M. Ch.	Permanent Speed Restrictions		Remarks
			Down m.p.h.	Up m.p.h.	
<u>LIVERPOOL STREET TO NORWICH</u> Page 57 (Page 23, SD PON) At Colchester (CO) <u>Amend</u> 'Remarks' column entry to read:-					Colchester (CO) signal box area between Colchester and Swainsthorpe.

SECTION D - GENERAL INSTRUCTIONS AND NOTICES - continued

EASTERN REGION SECTIONAL APPENDIX (SOUTHERN AREA) - continued

Running Lines and Signalling System	Location	M. Ch.	Permanent Speed Restrictions		Remarks
			Down m.p.h.	Up m.p.h.	
<u>LIVERPOOL STREET TO NORWICH - continued</u>					
Page 60 (Page 23, SD PON)					
At Haughley LC (AHB)					
<u>Amend</u> 'Remarks' column entry to read:-					
Pages 60 and 61 (Pages A29 and 24, SD PON)					
<u>Delete</u> all details between Mellis LC (AHB-X) and Trowse Lower Jn and <u>substitute:-</u>					
▲ ↑ ↓ ▼	Mellis LC (AHB-X)	91 34	X50	X50	<u>Approaching level crossing in wrong direction.</u>
Telephones to Colchester signal box are provided at all 2 aspect distant signals between 82½m.p. and 90m.p.					
Telephone to Colchester signal box at 92m. 77chs. (Signal CO 424R).					

SE-55

SECTION D - GENERAL INSTRUCTIONS AND NOTICES - continued

EASTERN REGION SECTIONAL APPENDIX (SOUTHERN AREA) - continued

Running Lines and Signalling System	Location	M. Ch.	Permanent Speed Restrictions		Remarks
			Down m.p.h.	Up m.p.h.	
LIVERPOOL STREET TO NORWICH - continued					
Pages 60 and 61 (Pages A29 and 24, SD PON) - continued:-					
Delete all details between Mellis LC (AHB-X) and Trowse Lower Jn and substitute - continued:-					
	Palgrave LC (AHB-X)	94 04	X50	X50	<u>Approaching level crossing in wrong direction.</u>
	Diss	94 79			
	Audley End (Norfolk) LC (AHB-X)	97 05	X50	X50	<u>Approaching level crossing in wrong direction.</u>
	Burston LC (AHB-X)	97 42	X50	X50	<u>Approaching level crossing in wrong direction.</u>

SE-56

SECTION D - GENERAL INSTRUCTIONS AND NOTICES - continued

EASTERN REGION SECTIONAL APPENDIX (SOUTHERN AREA) - continued

Running Lines and Signalling System	Location	M. Ch.	Permanent Speed Restrictions		Remarks
			Down m.p.h.	Up m.p.h.	
<u>LIVERPOOL STREET TO NORWICH - continued</u>					
Pages 60 and 61 (Pages A29 and 24, SD PON) - continued:-					
<u>Delete</u> all details between Mellis LC (AHB-X) and Trowse Lower Jn and <u>substitute</u> - continued:-					
	Gissing LC (AHB-X)	98 57	X50	X50	<u>Approaching level crossing in wrong direction.</u>
	Hales Street LC (AHB-X)	100 27	X50	X50	<u>Approaching level crossing in wrong direction.</u>
	Tivetshall LC (AHB-X)	100 43	X50	X50	<u>Approaching level crossing in wrong direction.</u>
	Moulton LC (AHB-X)	101 51	X50	X50	<u>Approaching level crossing in wrong direction.</u>
	Flordon	106 63			
					Telephones to Colchester signal box at 104m. 41chs. (Signal CO 448R) and at 105m. 19chs. (Signal CO 453R).

SE-57

SECTION D - GENERAL INSTRUCTIONS AND NOTICES - continued

EASTERN REGION SECTIONAL APPENDIX (SOUTHERN AREA) - continued

Running Lines and Signalling System	Location	M. Ch.	Permanent Speed Restrictions		Remarks	
			Down m.p.h.	Up m.p.h.		
<u>LIVERPOOL STREET TO NORWICH - continued</u>						
Pages 60 and 61 (Pages A29 and 24, SD PON) - continued:-						
Delete all details between Mellis LC (AHB-X) and Trowse Lower Jn and substitute - continued:-						
	Newton Flotman LC (AHB-X)	108 19	X50	X50	<u>Approaching level crossing in wrong direction.</u>	
	Swainsthorpe LC (AHB-X)	109 54	X50	X50	<u>Approaching level crossing in wrong direction.</u>	
				90	90	<u>111m. 15chs. and 110m. 55chs.</u>
				80	80	<u>111m. 15chs. and 112m. 62chs.</u>
				40	40	<u>112m. 62chs. and 113m. 46chs.</u>
			35		<u>113m. 46chs. and 123m.p.</u>	
	Trowse Lower Jn (See page 103)	113 68 123 00				

Telephones to Colchester signal box at 110m. 16chs. (Signal NO 541R) and at 111m. 07chs. (Signal CO 460R).

Norwich (NO) signal box area between Swainsthorpe (exclusive) and Trowse Lower Jn (exclusive).

SE-58

(12.SD)

SECTION D - GENERAL INSTRUCTIONS AND NOTICES - continued

EASTERN REGION SECTIONAL APPENDIX (SOUTHERN AREA) - continued

Running Lines and Signalling System	Location	M. Ch.	Permanent Speed Restrictions		Remarks
			Down m.p.h.	Up m.p.h.	
<u>BETHNAL GREEN JN TO KING'S LYMN</u>					
Page 82 (Page 35, SD PON)					
At Reading Lane Jn					
Amend:-					
			10		To Graham Road Curve line.
<u>READING LANE JN TO NAVARINO ROAD JN (GRAHAM ROAD CURVE)</u>					
Page 88 (Page 38, SD PON)					
Delete all details and substitute:-					
			30	30	MAXIMUM PERMISSIBLE SPEED
	Reading Lane Jn (See page 82)	2 55	10		<u>2m. 55chs. and 2m. 71chs.</u>
	Navarino Road Jn (See page 63)	2 79			

(12.SD)

SE-59

Controlled by Hackney Downs (H) signal box.

Controlled by Dalston Western Jn. (DW) signal box.

(12.SD)

SECTION D - GENERAL INSTRUCTIONS AND NOTICES - continued

EASTERN REGION SECTIONAL APPENDIX (SOUTHERN AREA) - continued

Running Lines and Signalling System	Location	M. Ch.	Permanent Speed Restrictions		Remarks
			Down m.p.h.	Up m.p.h.	
<p><u>ELY NORTH JN TO PETERBOROUGH, CRESCENT JN</u></p> <p><u>Page 97</u></p> <p>At Norwood Road LC</p> <p><u>Amend</u> 'Remarks' columns entry to read :-</p>					<p>UGL.76.</p> <p>(12.SD)</p>

SE-60

SECTION D - GENERAL INSTRUCTIONS AND NOTICES - continued

EASTERN REGION SECTIONAL APPENDIX (SOUTHERN AREA) - continued

Running Lines and Signalling System	Location	M. Ch.	Permanent Speed Restrictions		Remarks	
			Down m.p.h.	Up m.p.h.		
<p><u>ELY NORTH JN TO TROWSE LOWER JN</u></p> <p>Page 103</p> <p>Delete all details between Hethersett and Trowse Lower Jn and <u>substitute:-</u></p>						
	Hethersett (HT) LC	117 73			<p>URS 48 C. Up at 118m. 48chs. (457 yards after passing signal HT B).</p> <p>(12.SD)</p>	
	Intwood LC (AHB-X)	119 47	X30	X30		<u>Approaching level crossing in wrong direction.</u>
	Keswick LC (AHB-X)	120 00	X30	X30		<u>Approaching level crossing in wrong direction.</u>
	Eaton LC (R/G-X)	120 29	X30	X30		<u>Approaching level crossing in wrong direction.</u>
	Trowse Lower Jn (See page 61)	123 00				

SE-61

SECTION D - GENERAL INSTRUCTIONS AND NOTICES - continued

EASTERN REGION SECTIONAL APPENDIX (SOUTHERN AREA) - continued

Running Lines and Signalling System	Location	M. Ch.	Permanent Speed Restrictions		Remarks
			Down m.p.h.	Up m.p.h.	
<p><u>FENCHURCH STREET TO SHOEBURYNESS</u></p> <p><u>Pages 104 and 105</u></p> <p>Delete all details between Gas Factory Jn and East Ham and <u>substitute:-</u></p> 	Gas Factory Jn (See page 107)	2 57	<u>20</u>	<u>To Bow Jn line.</u>	
			<u>60</u>	<u>2m. 73chs. and 3m. 12chs.</u>	
			<u>70</u>	<u>3m. 12chs. and 6m.p.</u>	
	OHNS	3 75		<u>6m.p. and 2m. 73chs.</u>	
			<u>60</u>	<u>6m.p. and 6½m.p.</u>	
	East Ham	6 40	<u>40</u>	<u>6½m.p. and 7m. 08chs.</u>	
			<u>55</u>	<u>6m. 50chs. and 6m.p.</u>	

(12.SD)

SE-62

SECTION D - GENERAL INSTRUCTIONS AND NOTICES - continued

EASTERN REGION SECTIONAL APPENDIX (SOUTHERN AREA) - continued

Running Lines and Signalling System	Location	M. Ch.	Permanent Speed Restrictions		Remarks
			Down m.p.h.	Up m.p.h.	
<u>FENCHURCH STREET TO SHOEBURYNESS - continued</u>					
<u>Page 105</u>					
<u>Delete:-</u>	Dagenham East GF's	11 25			(12.SD)
<u>TILBURY RIVERSIDE TO PITSEA</u>					
<u>Amend:-</u>	Fobbing LC (AHB)	30 34			(12.SD)

SE-63

SECTION D - GENERAL INSTRUCTIONS AND NOTICES - continuedEASTERN REGION SECTIONAL APPENDIX (SOUTHERN AREA) - continuedINSTRUCTIONS RELATING TO THE RULE BOOKPage 264 (Pages 49 and 50,SD PON)POWER OPERATED POINTS - WRONG DIRECTION MOVEMENTS

<u>Signalbox/location</u>	<u>Point Nos.</u>	
<u>Amend</u> East Gate Jn entry to read :-		
East Gate Jn	25,29	(12.SD)

OTHER GENERAL INSTRUCTIONSPages 278 and 279 (Pages 56 and 57, SD PON)FIXED AUDIBLE TRACK CIRCUIT OPERATED WARNING SYSTEMS

<u>Location</u>	<u>Description</u>
<u>Add:-</u>	
<u>Fenchurch Street to Shoeburyness</u>	
Christian Street Jn.	Covers Down and Up Main lines between 0m. 62chs. and 0m. 72chs.
Stepney	Two independent systems covering Down and Up lines between:- (i) 1m. 10chs. and 1m. 26chs. (ii) 1m. 26chs. and 1m. 44chs.
	(12.SD)

SECTION D - GENERAL INSTRUCTIONS AND NOTICES - continuedEASTERN REGION SECTIONAL APPENDIX (SOUTHERN AREA) - continuedOTHER GENERAL INSTRUCTIONS - continued

Page 297 (Page A37, SD PON)

DOCKLANDS LIGHT RAILWAY LINE BETWEEN BOW JN AND STRATFORD STATION
(ADJACENT TO THE B.R. UP ELECTRIC LINE)

Delete heading and instructions and substitute:-

DOCKLANDS LIGHT RAILWAY LINES ADJACENT TO B.R. LINES
BETWEEN BOW JN AND STRATFORD AND BETWEEN CHRISTIAN STREET JN AND STEPNEY EAST

B.R. staff must observe the provisions of the previous instructions on pages 294 to 297 headed, "Instructions to Train Crews Working other than D.C. Electric trains and other staff concerned working over or in the vicinity of D.C. Electrified lines", except that reference to Electrical Control Operator should be read as Controller and Supervisor at Poplar Control Centre, who can be contacted via the Signaller at Bow Jn, Stratford or Fenchurch Street or the Electrical Control Operator at Romford or on British Telecom 538 3440.

The Docklands Light Railway when fully operational will work automatically without lineside signals, using Driverless trains which will approach in either direction travelling at a maximum speed of 50 m.p.h. Each train will convey a member of the Docklands Light Railway staff called a "Train Captain".

Docklands trains will not sound a warning to persons on or near the line etc., and B.R. staff must not, therefore, except in emergency go on to the Docklands Light Railway.

Between Bow Jn and Stratford posts are provided in the 10 foot between the Up Electric line and the Docklands line to identify the point beyond which staff must not proceed. When staff stand clear of the Up Electric line they must align themselves between the posts.

Between Christian Street Jn and Stepney East the only position of safety in accordance with Rule Book, Section B, Clause 5.3.4 is on the North (Down) side of the viaduct and on the approach of a B.R. train staff must immediately proceed to the North side.

Between Christian Street Jn and Stepney East and in the vicinity of Bow Jn signal box and overbridge 609 (Fairfield Road), staff must not, except in emergency, proceed beyond the fence between B.R. and Docklands line. If unavoidable circumstances compel staff to remain between the B.R. and Docklands lines when trains pass, they must lay down against the B.R. side of the fence. It is important that this instruction is observed as the collector shoes of Docklands Light Railway trains will pass in close proximity to the Docklands side of the fence.

SECTION D - GENERAL INSTRUCTIONS AND NOTICES - continuedEASTERN REGION SECTIONAL APPENDIX (SOUTHERN AREA) - continuedOTHER GENERAL INSTRUCTIONS - continuedPage 297 (Page A37, SD PON) - continuedDOCKLANDS LIGHT RAILWAY LINES ADJACENT TO B.R. LINES BETWEEN BOW JN AND STRATFORD AND BETWEEN CHRISTIAN STREET JN AND STEPNEY EAST - continued

If an emergency mishap occurs on B.R. lines requiring the stopping of trains on the Docklands Light Railway, standard B.R. protection arrangements must be observed and advice given to the Poplar Control Centre by the quickest available means. It should be noted that the placing of a Track Circuit Operating Clip on the Docklands line will stop a train which is in automatic mode.

(12.SD)

LOCAL INSTRUCTIONSPage 317WICKFORD TO SOUTHMINSTERAdd :- WOODHAM FERRERS A.O.C.L. LEVEL CROSSING

Woodham Ferrers level crossing must be worked in accordance with the General Appendix Instructions for A.O.C.L. level crossings, except that in the event of the red road signals not being automatically initiated, the Driver must press the plunger located in a locked Cabinet (Drivers No. 1 Key) on the White light post to activate the road signals. When the white light is flashing, the Driver may proceed as normal. If, after operation of the plunger, the white light still does not flash, the Driver must proceed in accordance with Clause 3.3 of the instructions.

(12.SD)

Page 327BETHNAL GREEN TO KING'S LYNNAdd:- DOWNHAM MARKET

Drivers of Up stopping passenger trains must stop in rear of the Up section signal, even though the signal may be displaying a green aspect and not proceed forward until the station duties have been completed.

(12.SD)

SECTION D - GENERAL INSTRUCTIONS AND NOTICES - continued

EASTERN REGION SECTIONAL APPENDIX (SOUTHERN AREA) - continued

LOCAL INSTRUCTIONS - continued

Page 333

FENCHURCH STREET TO SHOEBURYNESS

Add:- BETWEEN CHRISTIAN STREET JN AND STEPNEY EAST

Rule Book, Section B, Clause 5.3.8 and General Appendix Instruction -
Safety of Staff called by Signalman to work on the line

Staff must not commence work on the Up side of a train on the Up line unless they have received an assurance from the Signalman that trains on the Down Docklands line have been stopped.

If staff called by the Signalman to work on the line consider that they cannot work safely with trains running on the Down Docklands line, they must not commence work until an assurance has been received from the Signalman that Down Docklands trains have been stopped.

(12.SD)

MISCELLANEOUS NOTICES

INSTRUCTIONS FOR D.C. ELECTRIFIED LINES
BETWEEN ELSTON-WATFORD JN, CROXLEY GREEN-NORTH WOOLWICH B.R.29636

Supplement No. 2 to the above publication is in the course of being distributed.

Any member of staff who is in possession of the current issue of B.R.29636 who has not received a copy of the Supplement must promptly advise his Supervisor.

(37)

PERMANENTLY COUPLED D.B. 2 x 45 TONNE VANS

The West German Railways are manufacturing 200 45 tonne 2 axle general merchandise vans which will be permanently coupled in 100 pairs.

Each pair of wagons will be identified by a single number in the following range:-

23 80 2794 000-2 to 23 80 2794 099-4

Only one wagon in each pair is fitted with a distributor, and in the event of a coupling breaking the brakes would only apply on the wagon fitted with the distributor - the air supply to the "slave wagon" would be lost when the pipes parted.

SECTION D - GENERAL INSTRUCTIONS AND NOTICES - continued

MISCELLANEOUS NOTICES - continued

PERMANENTLY COUPLED D.B. 2 x 45 TONNE VANS - continued

For this reason:-

1. These wagons must not be included in a fully fitted block train of this type of wagon.
2. These wagons must not be included in the rear-most three positions of any other fully fitted freight train.
3. Any train including a pair of these wagons, must consist of a minimum of 5 vehicles, to avoid these D.B. wagons being in the last three.

The TOPS trainlist programme will be altered as soon as possible to reflect this.

(12.D)

WORKING INSTRUCTIONS FOR A.C. ELECTRIFIED LINES - BR.29987

From 1st December 1986, a new book will take effect which will replace the current edition dated 3rd May 1975 and the amendments thereto.

The book will be in loose leaf form, A5 size, with a flexible cover and its format has been designed so that part of the book can be separately issued in place of the existing "Extracts from the Working Instructions" book BR.29988, which will be discontinued from the same date.

The new book is divided into three main sections viz:-

Section A (BR.29987) - Definitions, Description of System and General Instructions. This will be issued to every employee working on or in the vicinity of lines electrified on the A.C. overhead line system.

Section B (BR.29987/14) - Isolation and Earthing of Overhead Line Equipment.

Section C (BR.29987/15) - Protection of Staff Servicing/Maintaining Locomotives or Trains in Sidings/Depots equipped for electric traction.

Note: Sections B and C will be issued only to staff involved with the instructions contained therein.

The new book is currently being distributed and the appropriate section(s), together with a copy of the explanatory leaflet, BR.29987/16, must be made available to staff immediately upon receipt.

Any member of the staff who is in possession of the current issue of the A.C. Working Instructions, or Extracts thereto, who has not received a copy of the appropriate section(s) of the new book must promptly advise his Supervisor.

SECTION D - GENERAL INSTRUCTIONS AND NOTICES - continuedMISCELLANEOUS NOTICES - continuedGREAT EASTERN ELECTRIFIED LINES : BARKING AREAINSTALLATION OF DEAD SECTION

A DEAD SECTION has been installed at overhead line structure number A7/12 at 7m. 12chs. on the UP MAIN, London side of Barking Flyover.

(12.SD)

WORKING OF CLASS 313 AND CLASS 416 ELECTRIC MULTIPLE UNIT
TRAINS BETWEEN DALSTON WESTERN JN AND STRATFORD MARKET

Class 313 Electric Multiple Units

These units must only work between Navarino Road Jn and Stratford Market stabling sidings when either the Graham Road Curve route to Liverpool Street is not available, or when the pantographs have failed to rise. When operating between Dalston Kingsland and Stratford Market stabling sidings and return in the D.C. mode, Drivers must not advance the controller beyond Notch 2.

THESE UNITS MUST NOT RUN BEYOND STRATFORD MARKET TOWARDS NORTH WOOLWICH.

Class 416 Electric Multiple Units

Not more than two Class 416 units may be coupled together.

When two Class 416 units are running in multiple between Dalston Western Jn and Stratford Market, including the stabling sidings or return, Drivers must not advance the controller beyond Notch 2.

(UFN)

BETWEEN STEPNEY EAST AND FENCHURCH STREET

Until further notice, staff of the Docklands Light Railway will be laying in track adjacent to the Up Main/Slow line between Stepney East Station (1m. 58chs.) and Fenchurch Street. Restricted clearances exist and Drivers must keep a sharp look out and be prepared to sound the warning horn as necessary.

(UFN)

BETHNAL GREEN STATION

Until Further Notice, whilst demolition work is taking place, Drivers of 4-Car EMU trains must stop their trains at the temporary stop boards provided.

(UFN)

SECTION D - GENERAL INSTRUCTIONS AND NOTICES - continuedMISCELLANEOUS NOTICES - continuedCAMBRIDGE HEATH STATION

Whilst platform repairs are taking place, Drivers of trains must stop their trains at the temporary stop boards provided.

(UFN)

LONDON FIELDS STATION

The station has reopened but platform repairs are taking place. Whilst this work is being carried out, Drivers must stop their trains at the temporary stop boards provided.

(UFN)

SAWBRIDGEWORTH STATION

The stop board on the Up platform has been temporarily moved 9 yards towards the Country side of its former position.

(UFN)

WANSTEAD PARK STATION

Whilst platform repairs are taking place, Drivers of Up trains must stop their trains at the temporary stop boards provided.

(UFN)

REPAIRS IN MOTIVE POWER DEPOTS, CARRIAGE SHEDS, WAGON REPAIR SHEDS AND WAREHOUSES

In connection with work being carried out at the undermentioned places, scaffolding or projections may be provided or unusual excavations may be made in the ground:-

Location	Nature of Work	Duration	Commencing date
Stratford T.M.D. All lines.	Repairs to Motive Power Depot. Cranes and mechanical equipment in use.	Continuously. Until Further Notice.	-
Ilford EMU Depot, Nos. 19 and 20 Roads.	Drainage.	08 00 to 17 00 daily. Until Further Notice.	-
Ilford EMU Depot, 'B' Shop Roads Nos. 3, 4 and 5.	Construction work. <u>Isolation of electrical sections C3, 4 and 5.</u>	Continuously. Until further notice.	-

SECTION D - GENERAL INSTRUCTIONS AND NOTICES - continuedMISCELLANEOUS NOTICES - continuedREPAIRS IN MOTIVE POWER DEPOTS, CARRIAGE SHEDS, WAGON REPAIR SHEDS AND WAREHOUSES - continued

In connection with work being carried out at the undermentioned places, scaffolding or projections may be provided or unusual excavations may be made in the ground:-

Location	Nature of Work	Duration	Commencing date
Ilford EMU Depot, Nos. 6, 7, 8, 9 and 10 Sidings (Country End) BLOCKED	Track renewal.	Continuously. Until further notice.	-
Ilford EMU Depot, Nos. 1 and 1A Ley Street Sidings BLOCKED	Construction work. <u>Isolation of electrical sections 361U.</u>	Continuously.	<u>From 09 30</u> <u>Saturday 22</u> <u>until 18 00</u> <u>Sunday 23</u> <u>November.</u>
Ilford EMU Depot, Nos. 11 to 16 inc. Sidings, Carriage Washer Roads, Ley Street Sidings Nos. 2, 3 and 4 (and connections), 'B' Shed Sidings Nos. 3, 4 and 5 (Country end) and connections to Repair Shop BLOCKED	Overhead line work. <u>Isolation of electrical sections 361DEHKRSTV.</u>	10 00 to 18 00. <u>Sunday 23</u> <u>November.</u>	-
Norwich Crown Point T. & R.S. M.D., All lines BLOCKED	Construction work (overhead line) and track maintenance. Mechanical equipment in use. <u>Possession to be given up for passage of trains.</u>	08 00 to 17 00 daily. Until further notice.	-
East Ham EMU Depot, All lines.	Shed reconstruction.	Continuously. Until Further Notice.	-

SECTION D - GENERAL INSTRUCTIONS AND NOTICES - continuedMISCELLANEOUS NOTICES - continuedREPAIRS IN MOTIVE POWER DEPOTS, CARRIAGE SHEDS, WAGON REPAIR SHEDS AND WAREHOUSES - continued

In connection with work being carried out at the undermentioned places, scaffolding or projections may be provided or unusual excavations may be made in the ground:-

Location	Nature of Work	Duration	Commencing date
East Ham EMU Depot, Washer Road BLOCKED	Repairs to washer plant. <u>Isolation of electrical sections 509A.</u>	Continuously. Until Further Notice.	-
East Ham EMU Depot, Nos. 10 and 11 Maintenance Shed Roads BLOCKED	Construction work. <u>Isolation of electrical sections EH10, EH11.</u>	Continuously. Until Further Notice.	-

MP.32/SE
YORK
13 NOVEMBER, 1986

C. McKEEVER
Regional Operations Manager

BRITISH RAIL
EASTERN REGION

SE

36

WEEKLY OPERATING NOTICE

CONTAINING

TEMPORARY SPEED RESTRICTIONS

TEMPORARY ENGINEERING WORKS

SIGNALLING AND
PERMANENT WAY ALTERATIONS

GENERAL INSTRUCTIONS AND NOTICES

SATURDAY 29 NOVEMBER

TO

FRIDAY 5 DECEMBER 1986

INCLUSIVE

Trainmen must pay particular attention to works contained in this notice and keep a good look-out for handsignals which may be exhibited in accordance with the Rules and Regulations.

Work at places other than those mentioned may be in progress and Drivers must be on the look-out and be prepared to stop or run at reduced speed when, and where, handsignals may be exhibited.



WARNING



A.C. ELECTRIFIED LINES - ANGLIA WEST

EXTENSION OF ELECTRIFICATION FROM BISHOPS STORTFORD TO CAMBRIDGE

The Overhead Line Equipment has been extended Northwards from Bishops Stortford through Stansted, Elsenham, Newport, Audley End, Great Chesterford, Whittlesford, Shelford and Shepreth Branch Junction to a point approximately 3/4 of a mile north of Cambridge Station.

From 00 01 hours, Monday 8th December 1986, the Overhead Line Equipment will be energised at 25,000 Volts and must thereafter be regarded as being 'ALIVE' at all times.

The limits of energisation will be:-

At 336 yards north of the 56 1/2 mile post north of Cambridge Station.

- Structure Nos:- C90/46 DOWN GOODS LOOP NORTH
- C90/50 DOWN MAIN
- C90/47 UP MAIN
- C90/52 CARRIAGE DEPOT ROAD NO. 5

At 82 yards East of the 55 mile post on Royston side of Shepreth Branch Junction.

- Structure Nos:- EC88/21 DOWN ROYSTON
- EC88/22 UP ROYSTON

The Working Instructions for A.C. Electrified Lines (B.R. 29987) will apply.



WARNING



* * * * *

A.C. ELECTRIFIED LINES - ANGLIA EAST

EXTENSION OF ELECTRIFICATION FROM HAUGHLEY JUNCTION TO TIVETSHALL

* The Overhead Line Equipment has been extended from Haughley Junction,
* through Diss to Tivetshall.

* From 00 01 hours, Monday, 1st December 1986, the Overhead Line Equipment
* will be energised at 25,000 Volts and must thereafter be regarded as
* being 'ALIVE' at all times.

* The limits of energisation will be:-

* At 100 mile post south of Tivetshall.

Structure Nos. B161/03 DOWN MAIN
B161/04 UP MAIN

* The Working Instructions for A.C. Electrified Lines (B.R. 29987) will
* apply.

(37)



WARNING



*
* ENERGISATION OF DOCKLANDS LIGHT RAILWAY BETWEEN *
* DELTA JUNCTION, STEPNEY EAST, CHRISTIAN STREET *
* JUNCTION AND TOWER GATEWAY. (ADJACENT TO *
* B.R. FENCHURCH STREET TO BARKING LINE). *
*
* The Conductor Rails between Delta Junction and Tower Gateway have *
* been energised at 750 volts D.C. and must be regarded as 'ALIVE' *
* at all times. *
* (12.SD) *
*

SECTION A

TEMPORARY SPEED RESTRICTIONS

(Until further notice unless otherwise specified)

Warning Boards and Indicators provided unless otherwise shown.

† Indicates that the Warning Boards and Indicators will be moved as the work progresses. Where two speeds are shown for a restriction e.g. 20 the Rule Book, Section U, Clause 1.2 applies. 40

RULE BOOK : SECTION U

An experimental speed indicator board with black figures on a yellow background will be used in the Warning Board and Speed Indicator board for the following Temporary Speed Restriction:-

Church Lane LC Down Up 29 24 29 57 20 Trackwork.
and Chelmsford

In addition to the above equipment an experimental black and white zebra striped board with twin high powered flashing white lights will be located at the A.W.S. temporary magnet for the Temporary Speed Restriction shown above. This board with lights does not affect the conditions for Drivers working over the Temporary Speed Restriction, being located only for the purpose of obtaining reactions to their effectiveness for sighting.

Drivers and Traction Inspectors encountering the experimental indicators are requested to submit their comments to the Regional Operations Manager, York under reference M045/1274 via their Local Supervisor.

Location	Lines affected	Mileage at or between		Restr- iction m.p.h.	Remarks
		M.	Ch.		
<u>LIVERPOOL STREET TO NORWICH</u>					
1 Bethnal Green Station Jn and Bow Jn	Down Main	Up Main	1 60	2 10	20 Trackwork. (86/33)
2 Bow Jn	Down Main	-	2 60	2 69	20 Bridgework (No. 46). (86/34)
3 Bow Jn	Down Electric	-	2 60	2 69	20 Bridgework (No. 46). (86/31)

SECTION A - TEMPORARY SPEED RESTRICTIONS - continued

Location	Lines affected		Mileage		Restr- iction m.p.h.	Remarks
			M. Ch.	M. Ch.		
<u>LIVERPOOL STREET TO NORWICH - continued</u>						
4 Bow Jn	-	Up Main	2 69	2 60	20	Bridgework (No. 46). <u>Warning</u> <u>board also</u> <u>provided on</u> <u>Up Cambridge</u> <u>line at</u> <u>3m. 12chs.</u> (86/34)
5 Bow Jn	-	Up Electric	2 69	2 60	20	Bridgework (No. 46). <u>Warning</u> <u>boards also</u> <u>provided on</u> <u>Up Main line</u> <u>at 3m. 27chs.</u> <u>and on Up</u> <u>Cambridge</u> <u>line at</u> <u>3m. 12chs.</u> (86/34)
6 Brentwood and Shenfield	Down Electric	-	19 15	19 20	20	Condition of track. (86/33) <u>Until 10 00</u> <u>Friday 5</u> <u>December.</u>
7 Brentwood and Ingatestone	Down Main	-	19 65	20 33	50	Condition of track. (86/14)
8 Church Lane LC and Chelmsford	Down	Up	29 24	29 57	20	Trackwork. (86/26)
9 Chelmsford and New Hall G.F.	Down	-	30 50	30 65	50	Condition of track. (86/12)
10 Hatfield Peverel and New Hall G.F.	-	Up	34 60 †	34 20	40	Trackwork. <u>From 09 00</u> <u>Monday 1</u> <u>December.</u> (86/36)

SECTION A - TEMPORARY SPEED RESTRICTIONS - continued

Location	Lines affected		Mileage at or between		Restr- iction m.p.h.	Remarks
			M. Ch.	M. Ch.		
<u>LIVERPOOL STREET TO NORWICH - continued</u>						
11 New Hall G.F. and Witham	Down	-	35 65	36 20	30	Trackwork. From 23 00 <u>Saturday 29</u> until 16 00 <u>Sunday 30</u> <u>November.</u>
12 Witham and New Hall G.F.	-	Up	36 20	35 65	20	Earthwork. (86/28)
13 Kelvedon	-	Up	42 25	42 10	<u>50</u> 80	Condition of track. (86/7)
14 Swainsthorpe LC and Lower Trowse Jn	Down	-	109 70	109 79	30	Earthwork. From 22 00 <u>Saturday 29</u> <u>November.</u> (86/36)
15 Trowse Lower Jn and Swainsthorpe LC	-	Up	112 60	112 40	30	Trackwork. (86/35)
<u>SHENFIELD JN TO SOUTHEND VICTORIA</u>						
16 Billericay and Wickford Station	Down	-	26 10	26 44	40	Condition of track. (86/14)
17 Wick Lane LC and Rayleigh	Down	-	31 35	31 75	40	Condition of embankment. (84/41)
<u>WICKFORD JN TO SOUTHMINSTER</u>						
18 Althorne LC and Burnham-on- Crouch	Single		41 10 †	42 10	20	Trackwork. (85/45)

SECTION A - TEMPORARY SPEED RESTRICTIONS - continued

Location	Lines affected	Mileage		Restr- iction	Remarks	
		M. Ch.	M. Ch.			
<u>WITHAM TO BRAINTREE</u>						
19 Cressing and Braintree	Single	18 75	18 68	20	Bridgework (No. 2102B). (86/29)	
<u>COLCHESTER TO CLACTON</u>						
20 Colchester Road - LC and Wivenhoe	Up	57 72 †	57 12	40	Condition of track. (86/26)	
<u>MANNINGTREE SOUTH JN TO HARWICH</u>						
21 Parkeston Goods - Jn and Wrabness	Up	66 70	66 10	<u>30</u> 50	Condition of track. (86/3) <u>Until 10 00</u> <u>Monday 1</u> <u>December.</u>	
<u>With effect from 10 00 hours Monday 1 December, the above speed restriction becomes permanent and appears in Section 'D' of this notice.</u>						
<u>EAST SUFFOLK JN TO OULTON BROAD NORTH JN</u>						
22 Bealings LC - and Westerfield Jn	Up	74 60 †	73 44	30	Condition of track. (86/33)	
<u>WESTERFIELD JN TO FELIXSTOWE</u>						
23 Trimley	Single	82 55	82 69	30	Trackwork. (86/33)	
<u>NORWICH TO LOWESTOFT</u>						
24 Thorpe Jn and Whitlingham Jn	Down	Up	0 36	0 44	20	Trackwork. (85/20)

SECTION A - TEMPORARY SPEED RESTRICTIONS - continued

Location	Lines affected		Mileage		Restr- iction m.p.h.	Remarks
			at M.	between Ch. M. Ch.		
<u>BRUNDALL JN TO YARMOUTH VIA ACLE</u>						
25 Chapel Road LC	Single		7 54	7 57	30	Trackwork. From 22 00 <u>Saturday 29</u> <u>November</u> until 15 00 <u>Thursday 4</u> <u>December.</u>
<u>BETHNAL GREEN JN TO KING'S LYNN</u>						
26 Tottenham South Jn	Down	-	5 39	5 43	20	Condition of track. (86/32)
27 Enfield Lock	-	Up	11 71	11 60	50	Condition of track. (86/31)
28 Sawbridgeworth and Harlow Mill	-	Up	24 76	24 70	60	Condition of track. (86/16)
29 Ickleton Road LC and Hinxton LC	Down	-	46 00	46 60	20	Trackwork. <u>From 00 10</u> <u>until 16 00</u> <u>Sunday 30</u> <u>November.</u>
30 Hinxton LC and Ickleton Road LC	-	Up	46 60	46 00	20	Trackwork. <u>Until 00 10</u> <u>Sunday 30</u> <u>November.</u> (86/35)
31 Hinxton LC and Ickleton Road LC	-	Up	46 60	46 00	40	Trackwork. <u>From 00 10</u> <u>Sunday 30</u> <u>November</u> until 14 00 <u>Friday 5</u> <u>December.</u>
32 Whittlesford Station	-	Up	49 10	49 00	40	Platform work. (86/35)

SECTION A - TEMPORARY SPEED RESTRICTIONS - continued

Location	Lines affected	Mileage		Restr- iction m.p.h.	Remarks
		at or between M. Ch. M. Ch.			
<u>HACKNEY DOWNS NORTH JN TO ENFIELD TOWN</u>					
33 Stamford Hill	-	Up	5 12 4 78	20	Condition of track. (86/34)
34 Silver Street and Bury Street Jn	Down	Up	8 40 8 67	20	Trackwork. (86/34)
<u>ELY NORTH JN TO PETERBOROUGH, CRESCENT JN</u>					
35 Third Drove LC and Welney Road LC	Down	Up	78 00 78 18	20	Condition of track. (86/21)
36 Third Drove LC and Welney Road LC	Down	Up	78 42 78 60	20	Condition of track. (86/21)
37 March East Jn and Badgeney Road LC	-	Up Main	85 36 85 32	10	Condition of track. <u>Warning board positioned at signal ME.45.</u> <u>Additional warning board provided on the March East Jn to Wisbech line, positioned at signal ME.52.</u> (86/31)
38 Three Horse Shoes No. 3 LC	Down	Up	90 74 90 78	<u>20</u> 50	Condition of track. (86/24)
<u>ELY NORTH JN TO TROWSE LOWER JN</u>					
39 Hethersett and Trowse Lower Jn	Down	-	118 60 120 30	60	Signalling work. (86/33)

SECTION A - TEMPORARY SPEED RESTRICTIONS - continued

Location	Lines affected		Mileage		Restr- iction m.p.h.	Remarks	
			at M.	or between Ch. M. Ch.			
<u>ELY NORTH JN TO TROWSE LOWER JN - continued</u>							
40	Trowse Lower Jn and Hethersett	-	Up	121 15	119 47	60	Signalling work. (86/33)
41	Eaton LC and Trowse Lower Jn	Down	Up	121 60	121 64	20	Bridgework (Nos. 1640 and 1640A). (86/23)
<u>FENCHURCH STREET TO SHOEBURYNNESS</u>							
42	Gas Factory Jn and East Ham	Down	Up	4 02 †	4 22	20	Trackwork. (86/35)
<u>UPPER HOLLOWAY TO BARKING, TILBURY LINE JN WEST</u>							
43	South Tottenham East Jn and Black Horse Road	Down	-	6 45	6 57	20	Condition of track. (85/18)
44	Walthamstow Queens Road and Leyton Midland Road	Down	Up	8 34	8 39	20	Trackwork. (86/35)
<u>TILBURY RIVERSIDE TO PITSEA</u>							
45	Stanford-le- Hope and Gardners LC	Down	-	30 11	30 60	20	Trackwork. (86/34)
46	Gardners LC and Stanford-le- Hope	-	Up	30 60	30 11	30	Trackwork. (86/34)

SECTION B

TEMPORARY ENGINEERING WORKS

At or between	Lines affected	Remarks
<u>LIVERPOOL STREET TO NORWICH</u>		
UNTIL FURTHER NOTICE		
47	Liverpool Street Station Platform 1	Demolition work. Mechanical equipment in use. (86/30)
48	Liverpool Street Station Platforms 1 to 10 Inc.	Repairs to station roof. Mechanical equipment in use. (84/41)
49	Liverpool Street Station Platforms 1 to 18 inc.	Cleaning track. (85/21)
50	Liverpool Street Station Platforms 8, 10 and 11 to 18 inc.	Platform work and construction work. Mechanical equipment in use. (86/21)
51	Bethnal Green Station Down Main and Down and Up Suburban	08 00 to 16 00. Demolition work. (See Section 'D'). (85/41)
52	Bethnal Green and Bow Jn All	Signalling work. (86/25)
53	Stratford and Bow Jn Up Electric	07 30 to 18 00. Construction work. Mechanical equipment in use. (85/62)
54	Forest Gate Jn and Ilford All	07 00 to 18 00. Bridgework (No. 75A). 7m. 08chs. Mechanical equipment in use. (85/20)
55	Ilford Station All	08 00 to 17 00. Repairs to station roof and painting station. (86/2)
56	Romford Jn and Gidea Park All	Bridgework (No. 102B). 12m. 48chs. Crane and mechanical equipment in use. (85/54)
57	Ingatestone and Chelmsford Down and Up	07 30 to 18 00. Construction of bridge (No. 143A). 26m. 51chs. Mechanical equipment in use. (84/35)

SECTION B - TEMPORARY ENGINEERING WORKS - continued

At or between	Lines affected	Remarks
<u>LIVERPOOL STREET TO NORWICH - continued</u>		
UNTIL FURTHER NOTICE - continued		
58 Mellis LC and Trowse Lower Jn	All <u>Between Trains</u>	07 30 to 18 00. Signalling work. Points and signals disconnected. (86/15)
59 Diss	Down and Up	07 00 to 19 00. Earthwork. Crane and mechanical equipment in use. (85/27)
60 Diss and Audley End LC	Down and Up	Bridgework (No. 315). 95m. 29chs. (86/16)
61 Gissing LC	Down and Up	08 00 to 16 00. Level crossing road repairs. 98m. 56chs. Mechanical equipment in use. (86/26)
62 Hales Street LC	Down and Up	08 00 to 16 00. Level crossing road repairs. 100m. 26chs. Mechanical equipment in use. (86/28)
63 Tivetshall LC	Down and Up	07 30 to 18 00. Demolition work and level crossing road repairs. (Tivetshall LC). 100 ³ / ₄ m.p. Mechanical equipment in use. (86/28)
64 Newton Flotman LC	Down and Up	08 00 to 16 00. Level crossing road repairs. 108m. 17chs. Mechanical equipment in use. (86/26)
65 Swainsthorpe LC	Down and Up <u>Between Trains</u>	07 30 to 18 00. Level crossing road repairs and demolition work. 109m. 52chs. and 109 ³ / ₄ m.p. Mechanical equipment in use. (86/30)
66 Swainsthorpe LC and Trowse Lower Jn.	Down and Up	07 00 to 16 00. Bridgework (No. 346). 110m. 62chs. Mechanical equipment in use. (86/25)
67 Trowse Lower Jn and Norwich Station	All <u>Between Trains</u>	07 00 to 17 00. Construction work (overhead line), earthwork, track maintenance and signalling work. Points and signals disconnected. (86/7)
68 Trowse Swing Bridge	Down and Up <u>Between Trains</u>	Bridgework (No. 356). 123m. 36chs. Crane and mechanical equipment in use. (85/33)

SECTION B - TEMPORARY ENGINEERING WORKS - continued

At or between	Lines affected	Remarks
---------------	----------------	---------

LIVERPOOL STREET TO NORWICH - continued

UNTIL FURTHER NOTICE - continued

69	Trowse Swing Bridge and Thorpe Jn	Down and Up <u>Between Trains</u>	07 30 to 18 00. Construction work. 123 $\frac{1}{2}$ m.p. Crane and mechanical equipment in use. (86/3)
----	---	--------------------------------------	---

FRIDAY/SATURDAY 28/29 NOVEMBER

70	Liverpool Street Station	Platforms 1, 2, 3 and 4 BLOCKED	23 00 to 05 15. Repairs to station roof. <u>Isolation of electrical sections 306ABC. Trains to be replatformed as necessary.</u>
----	-----------------------------	---------------------------------------	---

FRIDAY 28 NOVEMBER TO MONDAY 1 DECEMBER

71	Bethnal Green and Stratford (London End)	Down and Up Electric BLOCKED	23 00 Fri to 05 00 Mon. Bridgework (No. 46), overhead line work and signalling work. Mechanical equipment in use. <u>Isolation of electrical sections 309A, 310B.</u> <u>23 00 Fri to 00 15 Sat.</u> <u>Trains to travel over Main lines.</u> <u>00 15 to 12 00 Sat Diesel trains to/ from Stratford direction to travel over Down Main line under single line working between Liverpool Street and Bow Jn. then over other lines.</u> <u>Trains to/from Hackney Downs direction to travel over Suburban lines between Liverpool Street and Bethnal Green (Country End).</u> <u>12 00 Sat to 00 01 Mon 1Y02 02 20</u> <u>Liverpool Street to Stowmarket, 1W46</u> <u>03 15 Liverpool Street to Shenfield</u> <u>and 1K06 03 45 Liverpool Street to</u> <u>Southend Victoria diverted via</u> <u>Tottenham Hale (See Section 'D').</u> <u>00 01 to 05 00 Mon Trains to/from</u> <u>Stratford direction to travel over</u> <u>Down Main line under single line</u> <u>working between Liverpool Street and</u> <u>Bow Jn. then over other lines.</u> <u>Trains to/from Hackney Downs</u> <u>direction to travel over Suburban</u> <u>lines between Liverpool Street and</u> <u>Bethnal Green (Country End). (See</u> <u>Section 'C').</u>
----	--	------------------------------------	--

SECTION B - TEMPORARY ENGINEERING WORKS - continued

<u>At or between</u>	<u>Lines affected</u>	<u>Remarks</u>
----------------------	-----------------------	----------------

LIVERPOOL STREET TO NORWICH - continued

SATURDAY 29 NOVEMBER

72	Liverpool Street Station	Platforms 16 and 17 BLOCKED	00 15 to 12 00. Construction work. Mechanical equipment in use. <u>Trains to be replatformed as necessary.</u>
73	Liverpool Street Station	Platforms 8, 9 and 10 BLOCKED Platform 7 and London End Entry/Exit to/from Locomotive Holding Sidings BLOCKED to electric trains	05 00 to 12 30. Repairs to station roof. <u>Isolation of electrical sections 305CEFGH. Trains to be replatformed as necessary.</u>
74	Liverpool Street and Bethnal Green	Down and Up Electric BLOCKED to electric trains)00 20 to 11 50. In connection with engineering work. <u>Isolation of electrical sections 301 and 302.</u>) <u>Electric trains to travel over Suburban lines and to be replatformed as necessary.</u>
	Liverpool Street Station	Platforms 15, 16, 17 and 18 BLOCKED to electric trains)))
75	Liverpool Street and Bethnal Green	Down and Up Electric BLOCKED)01 30 to 10 30. Bridgework (No. 18),)construction work, undertrack)excavation and dismantling)scaffolding. <u>Trains to travel over Main lines and to be replatformed as necessary.</u>
	Liverpool Street	Approaches to Platforms 15, 16, 17 and 18 BLOCKED)))

SATURDAY 29 TO SUNDAY 30 NOVEMBER

76	Swainsthorpe LC/Hethersett and Norwich Station	All	07 00 Sat to 22 00 Sun. Signalling work and track renewal. Points and signals disconnected. <u>(See Section 'C').</u>
----	--	-----	--

SECTION B - TEMPORARY ENGINEERING WORKS - continued

At or between	Lines affected	Remarks
---------------	----------------	---------

LIVERPOOL STREET TO NORWICH - continued

SATURDAY 29 TO SUNDAY 30 NOVEMBER

77	Liverpool Street and Bethnal Green	Down and Up Suburban BLOCKED to electric trains	12 30 Sat to 23 00 Sun)	Repairs to station roof and construction work.
	Liverpool Street Station	Platforms 9 and 10 BLOCKED	12 30 to 23 00 Sat)Isolation of electrical sections 305 and 306.
		Platforms 9 and 10 BLOCKED to electric trains	23 30 Sat to 04 15)12 30 to 23 00 Sat Electric trains to travel over Main or
		Platforms 1 to 8 inc. (and approaches) BLOCKED	12 39 Sat to 23 00 Sun)	Electric lines. Possession to be given up for passage of
		Platforms 9 and 10 BLOCKED	04 15 to 23 00 Sun)3C01 11 22 Colchester to Liverpool Street and 5H14 14 26 Liverpool Street to Broxbourne to/from Platform 10. Other trains to be replatformed

as necessary. 23 00 Sat to 04 15. Electric trains to travel over Main or Electric lines. Trains to be replatformed as necessary. Diesel trains travelling to/from platforms 9 and 10 and Main lines NOT affected. 04 15 to 23 00 Sun Electric trains to travel over Main or Electric lines. Trains to be replatformed as necessary.

SECTION B - TEMPORARY ENGINEERING WORKS - continued

At or between	Lines affected	Remarks
---------------	----------------	---------

LIVERPOOL STREET TO NORWICH - continued

SATURDAY/SUNDAY 29/30 AND SUNDAY 30 NOVEMBER

84	Church Lane LC and New Hall G.F.	Up Main BLOCKED Down Main BLOCKED Down Main	23 25 Sat to 13 45 00 10 to 13 50 Sun 13 50 to 16 00 Sun)Track maintenance,)track renewal,)repairs to platform)awnings (Chelmsford)Station) and)overhead line work.)Mechanical)equipment in use.)Possession to be)given up for)passage of 1Y02)02 20 Liverpool)Street to)Stowmarket over)Up Main line under)single line)working.
85	New Hall G.F. and Witham	Up BLOCKED Down BLOCKED	23 15 Sat to 15 15 00 10 to 13 30 Sun)Track maintenance,)track renewal,)formation renewal,)drainage and)overhead line work.)Crane and)mechanical)equipment in use.)00 10 to 13 30 Sun.)Possession to be)given up for 1Y02)02 20 Liverpool)Street to)Stowmarket)over Down line.)13 30 to 15 15)Sun Single line)working over)Down line.

SECTION B - TEMPORARY ENGINEERING WORKS - continued

<u>At or between</u>	<u>Lines affected</u>	<u>Remarks</u>
<u>LIVERPOOL STREET TO NORWICH - continued</u>		
SATURDAY/SUNDAY 29/30 AND SUNDAY 30 NOVEMBER - continued		
86 Witham and Marks Tey Station	Up BLOCKED Down BLOCKED	23 30 Sat to 07 00)Track maintenance)and loading and 00 25 to 07 00 Sun)unloading)materials. Crane)and mechanical)equipment in use.) <u>Possession to be given up for passage of 1Y02 02 20 Liverpool Street to Stowmarket over Down line and Engineers' trains. 00 30 to 07 00 Sun Isolation of electrical sections 337 and 338.</u>
87 Colchester Station and Manningtree Station/ East Gate Jn	Up Main and Clacton Single BLOCKED Down Main BLOCKED	23 40 Sat to 06 00)Track maintenance,)earthwork and)loading materials. 00 35 to 07 30 Sun)Mechanical)equipment in use.) <u>23 40 Sat to 06 00 Isolation of electrical sections 339AK, 341BC. 00 35 to 07 30 Sun Possession to be given up for passage of 1Y02 02 20 Liverpool Street to Stowmarket over Down Main line.</u>

SECTION B - TEMPORARY ENGINEERING WORKS - continued

At or between	Lines affected	Remarks
---------------	----------------	---------

LIVERPOOL STREET TO NORWICH - continuedSATURDAY/SUNDAY 29/30 AND SUNDAY 30 NOVEMBER - continued

88 Trowse Jn and Trowse Yard	Up Main	22 00 Sat to 07 00)Track renewal)between crossover)at 113m. 34chs.)and Trowse Yard.)Crane and)mechanical)equipment in use.) <u>2P64 21 20</u>) <u>Cambridge to</u>) <u>Norwich and 1P04</u>) <u>02 10 Liverpool</u>) <u>Street to Yarmouth</u>) <u>to travel over</u>) <u>Trowse Loop</u>) <u>(See Section 'C')</u> .
	BLOCKED		
	Down Main	23 55 Sat to 07 00	
	BLOCKED		
	Down and Up Main <u>Between Trains</u>	07 00 to 12 00 Sun	
89 Trowse Swing Bridge and Thorpe Jn	Up	21 15 Sat to 12 00)Track maintenance)and track renewal.)Crane and)mechanical equipment)in use.) <u>23 55 Sat to 07 00</u>) <u>Possession to</u>) <u>be given up for</u>) <u>passage of trains</u>) <u>over Down line.</u>) <u>07 00 to 12 00 Sun</u>) <u>Single line working</u>) <u>over Down line.</u>) <u>(See Section 'C')</u> .
	BLOCKED		
	Down	23 55 Sat to 07 00	
	BLOCKED		
	Down and Up <u>Between Trains</u>	12 00 to 16 00 Sun	

SECTION B - TEMPORARY ENGINEERING WORKS - continued

At or between	Lines affected	Remarks
---------------	----------------	---------

LIVERPOOL STREET TO NORWICH - continued

SATURDAY 29 NOVEMBER TO MONDAY 1 DECEMBER

90	Bethnal Green and Bow Jn	Down Main	00 15 to 12 00 Sat)Bridgework (No. 46) and)overhead line)work.)Mechanical)equipment in)use.) <u>00 15 Sat to</u>) <u>00 01 Mon.</u>) <u>Isolation of</u> <u>electrical sections 311B, 312B.</u> <u>00 15 to 12 00 Sat Diesel trains</u> <u>to/from Stratford direction to travel</u> <u>over Down Main line under single line</u> <u>working between Liverpool Street and</u> <u>Bow Jn. Trains to/from Hackney Downs</u> <u>direction to travel over Suburban</u> <u>lines between lines between Liverpool</u> <u>Street and Bethnal Green (Country</u> <u>End). 12 00 Sat to 00 01 Mon 1Y02</u> <u>02 20 Liverpool Street to Stowmarket,</u> <u>1W46 03 15 Liverpool Street to</u> <u>Shenfield and 1K06 03 45 Liverpool</u> <u>Street to Southend Victoria diverted</u> <u>via Tottenham Hale. (See Section 'D').</u> <u>00 01 to 05 00 Mon Trains to/from</u> <u>Stratford direction to travel over</u> <u>Down Main line under single line</u> <u>working between Liverpool Street and</u> <u>Bow Jn. Trains to/from Hackney Downs</u> <u>direction to travel over Suburban</u> <u>lines between Liverpool Street and</u> <u>Bethnal Green (Country End).</u>
		BLOCKED to electric trains		
		Up Main	00 15 Sat to 05 00 Mon	
		BLOCKED	12 00 Sat to 00 01 Mon	
	Down Main			
	BLOCKED			
	Down Main			

SUNDAY 30 NOVEMBER

91	Gidea Park	Down Electric	08 00 to 16 00. Signalling work (No. 43B points).
92	Shenfield and Witham	All BLOCKED to electric trains	00 10 to 13 30. In connection with engineering work. <u>Isolation of</u> <u>electrical sections 333, 334, 335 and</u> <u>336.</u>

SECTION B - TEMPORARY ENGINEERING WORKS - continued

At or between	Lines affected	Remarks
---------------	----------------	---------

LIVERPOOL STREET TO NORWICH - continuedSUNDAY 30 NOVEMBER - continued

93	Marks Tey Station and Colchester	Down and Up Main BLOCKED	00 35 to 07 15. Track maintenance and unloading materials. Mechanical equipment in use. <u>Possession to be given up for passage of 1Y02 02 20 Liverpool Street to Stowmarket over Down Main line and Engineers' trains.</u>
94	Manningtree North Jn and Halifax Jn	Down BLOCKED	00 45 to 08 00. Trimming lineside vegetation. Mechanical equipment in use. <u>Isolation of electrical sections 344B. Possession to be given up for passage of 1Y02 02 20 Liverpool Street to Stowmarket.</u>

SUNDAY 30 NOVEMBER TO FRIDAY 5 DECEMBER

95	Trowse Swing Bridge and Norwich Station	'C' Line BLOCKED 'D' and 'W' lines <u>Between Trains</u>	23 45 Sun to Thu to 05 00 Mon to Fri. Construction work (overhead line).
96	Norwich and Whitlingham Jn	'A' and 'E' lines/Down and Up Lowestoft/ Main BLOCKED)23 30 Sun to Thu to 05 00 Mon to Fri.)Construction work (overhead line).) <u>Possession to be given up for passage of trains.</u>))
	Norwich Station	Platforms 4, 5 and 6 BLOCKED)))

MONDAY 1 DECEMBER

97	Liverpool Street Station	Platforms 16 and 17 BLOCKED	00 01 to 05 00. Construction work. Mechanical equipment in use. <u>Trains to be replatfoemed as necessary.</u>
98	Ilford Car Sheds (Country End Jn) and Romford Jn	Down and Up Electric BLOCKED	01 00 to 05 00. Overhead line work. <u>Isolation of electrical sections 321A, 322K, 325E, 326A. Trains to travel over Main lines.</u>

SECTION B - TEMPORARY ENGINEERING WORKS - continued

At or between	Lines affected	Remarks
<u>LIVERPOOL STREET TO NORWICH - continued</u>		
MONDAY 1 DECEMBER - continued		
99 Chelmsford (London End) and Hill House G.F.	All BLOCKED to electric trains	01 20 to 04 20. In connection with overhead line work between Chelmsford and Witham. <u>Isolation of electrical sections 335, 336, 337 and 338.</u>
100 Chelmsford (Country End) and Witham	Down and Up BLOCKED	01 20 to 04 20. Overhead line work. <u>Possession to be given up for passage of Diesel trains.</u>
101 Stanway G.F. and Marks Tey Station	Up Main BLOCKED	00 01 to 04 45. Track maintenance. Mechanical equipment in use. <u>Single line working over Down Main line.</u>
MONDAY/TUESDAY 1/2 DECEMBER		
102 Flordon and Trowse Jn	Down BLOCKED	22 50 to 04 30. Track maintenance between Flordon and crossover at 113m. 34chs. Mechanical equipment in use. <u>Single line working over Up line.</u>
MONDAY 1 TO FRIDAY 5 DECEMBER		
103 Liverpool Street Station	Platform 16 BLOCKED	11 25 to 15 25 daily. Construction work. Mechanical equipment in use. <u>Isolation of electrical sections 302B. Trains to be replatformed as necessary.</u>
104 Liverpool Street Station	Platforms 16 and 17 BLOCKED	23 55 Mon to Thu to 05 00 Tue to Fri. Construction work. Mechanical equipment in use. <u>Isolation of electrical sections 301D, 302B. Trains to be replatformed as necessary.</u>
105 Gidea Park Jn and Shenfield (Country End)	Down and Up Electric BLOCKED	21 15 Mon to Thu to 04 00 Tue to Fri. Track maintenance, reballasting and overhead line work. Mechanical equipment in use. <u>Isolation of electrical sections 329EF, 330AB. Trains to travel over Main lines. Trains to/from Southend direction to travel over Southend lines.</u>

SECTION B - TEMPORARY ENGINEERING WORKS - continued

At or between	Lines affected	Remarks
---------------	----------------	---------

LIVERPOOL STREET TO NORWICH - continued

TUESDAY/WEDNESDAY 2/3 DECEMBER

106	Diss and Flordon	Down BLOCKED	22 45 to 04 30. Track maintenance. Mechanical equipment in use. <u>Single line working over Up line.</u>
-----	------------------	-----------------	--

TUESDAY 2 TO THURSDAY 4 DECEMBER

107	Church Lane LC and Chelmsford	Down BLOCKED	00 10 to 05 00 daily. Track maintenance. Mechanical equipment in use. <u>Single line working over Up line.</u>
-----	-------------------------------	-----------------	--

WEDNESDAY/THURSDAY 3/4 DECEMBER

108	Bethnal Green and Stratford (London End)	Down and Up Electric BLOCKED	23 15 to 05 00. Track maintenance. Mechanical equipment in use. <u>Trains to travel over Main lines.</u>
109	Cow Green and Diss	Down BLOCKED	22 30 to 04 15. Track maintenance. Mechanical equipment in use. <u>Single line working over Up line.</u>

FRIDAY 5 DECEMBER

110	Colchester and Stanway G.F.	Up Main BLOCKED	00 10 to 04 40. Track maintenance. Mechanical equipment in use. <u>Single line working over Down Main line.</u>
-----	-----------------------------	--------------------	---

FRIDAY/SATURDAY 5/6 DECEMBER

111	Gidea Park Jn and Shenfield (London End Jn)	Down and Up Main BLOCKED	21 15 to 05 00. Overhead line work. Mechanical equipment in use. <u>Isolation of electrical sections 331D, 332A. Trains to travel over Electric lines.</u>
-----	---	--------------------------------	--

SECTION B - TEMPORARY ENGINEERING WORKS - continued

At or between	Lines affected	Remarks
---------------	----------------	---------

LIVERPOOL STREET TO NORWICH - continued

FRIDAY 5 TO MONDAY 8 DECEMBER

112	Bethnal Green and Bow Jn	Down and Up Main BLOCKED	23 00 Fri to 05 00 Mon. Bridgework (No. 36), signalling work and overhead line work. Mechanical equipment in use. <u>Isolation of electrical sections 311B, 312B.</u> <u>23 00 Fri to 00 15 Sat Trains to travel over Electric lines.</u> <u>00 15 to 12 00 Sat. Diesel trains to/from Stratford direction to travel over Up Electric (between Bow Jn and Wheler Street Jn)/Up Main (between Wheler Street Jn and Liverpool Street) line under single line working. Trains to/from Hackney Downs direction to travel over Suburban lines between Liverpool Street and Bethnal Green (Country End).</u> <u>12 00 Sat to 00 01 Mon 1Y02 02 20 Liverpool Street to Stowmarket, 1W46 03 15 Liverpool Street to Shenfield and 1K06 03 45 Liverpool Street to Southend Victoria diverted via Tottenham Hale.</u> <u>00 01 to 05 00 Mon. Trains to/from Stratford direction to travel over Up Electric (between Bow Jn and Wheler Street Jn)/Up Main (between Wheler Street Jn and Liverpool Street) line under single line working. Trains to/from Hackney Downs direction to travel over Suburban lines between Liverpool Street and Bethnal Green (Country End).</u>
-----	--------------------------	-----------------------------	--

NAVARINO ROAD JN TO NORTH WOOLWICH

UNTIL FURTHER NOTICE

113	Highbury and Homerton	All	07 30 to 18 00. Earthwork and construction work. Mechanical equipment in use.
-----	-----------------------	-----	---

SECTION B - TEMPORARY ENGINEERING WORKS - continued

At or between	Lines affected	Remarks
---------------	-------------------	---------

NAVARINO ROAD JN TO NORTH WOOLWICH - continued

SUNDAY 30 DECEMBER

114	Dalston Western Jn and Hackney Central	All BLOCKED to AC electric trains	00 01 to 08 00. In connection with engineering work between Dalston Western Jn and Lea Jn. <u>Isolation of electrical sections 314DEFJK.</u>
115	Dalston Western Jn and Lea Jn	All BLOCKED	00 01 to 08 00. Track maintenance, track renewal and demolition work. Crane and mechanical equipment in use. <u>Isolation of DC electrical sections 707, 708, 709B, 710A.</u>

CHANNELSEA SOUTH JN TO STRATFORD CENTRAL JN WEST

UNTIL FURTHER NOTICE

116	Channelsea South Jn and Stratford Central Jn West	Down and Up BLOCKED to electric trains	In connection with engineering work. (86/14)
-----	--	--	---

FOREST GATE JN TO WOODGRANGE PARK JN

SUNDAY 30 NOVEMBER

117	Forest Gate Jn and Barking Tilbury Line Jn West	Down and Up BLOCKED	00 50 to 18 00. Track maintenance, undertrack excavation, bridgework (No. 14A) and overhead line work. Crane and mechanical equipment in use. <u>12 00 to 18 00 Possession to be given up for passage of Engineers' trains.</u>
-----	--	------------------------	---

SUNDAY 30 NOVEMBER TO MONDAY 1 DECEMBER

118	Forest Gate Jn and Barking Tilbury Line Jn West	Down and Up BLOCKED to electric trains	00 50 Sun to 04 00 Mon. In connection with engineering work. <u>Isolation of electrical sections 512AB, 513EF.</u>
-----	--	--	---

ROMFORD TO UPMINSTER

SUNDAY 30 NOVEMBER

119	Romford and Upminster	Single	08 00 to 17 00. Signalling work.
-----	--------------------------	--------	----------------------------------

SECTION B - TEMPORARY ENGINEERING WORKS - continued

At or between	Lines affected	Remarks
<u>SHENFIELD JN TO SOUTHEND VICTORIA</u>		
UNTIL FURTHER NOTICE		
120	Billericay Down and Up	07 30 to 17 30. Construction work and platform work. Mechanical equipment in use. (86/19)
121	Wickford Station	All Platform work and earthwork. (85/63)
122	Wickford Jn	All 08 00 to 17 00. Signalling work. (85/41)
123	Rayleigh and Hockley	Down 08 00 to 17 00. Earthwork 34½ and 34¾ m.p. Mechanical equipment in use. (85/61)
124	Southend Victoria Station	All 08 00 to 18 00. Repairs to station roof. (86/20)
<u>WICKFORD JN TO SOUTHMINSTER</u>		
UNTIL FURTHER NOTICE		
125	Wickford Jn	All 08 00 to 17 00. Signalling work. (85/41)
126	Fambridge Station	Single 07 30 to 18 00. Platform work. (85/55)
127	Burnham-on-Crouch	Single 07 30 to 18 00. Earthwork. 43m 24chs. (85/30)
SATURDAY 29 NOVEMBER		
128	Wickford Jn and Southminster	Single + BLOCKED 00 01 to 04 45. Unloading materials.
SUNDAY 30 NOVEMBER		
129	Wickford Jn and Southminster	Single BLOCKED 00 30 to 08 00. Track maintenance. Mechanical equipment in use.

SECTION B - TEMPORARY ENGINEERING WORKS - continued

At or between	Lines affected	Remarks
<u>WITHAM TO BRAINTREE</u>		
UNTIL FURTHER NOTICE		
130 Witham and Braintree	Single	07 00 to 18 00. Construction work (Bridge No. 2102B). (86/19)
FRIDAY/SATURDAY 28/29 NOVEMBER		
131 Witham and Braintree	Single BLOCKED	23 40 to 05 30. Bridgework (No.2102B). Mechanical equipment in use. <u>Isolation of electrical sections 379.</u>
MONDAY 1 TO SATURDAY 6 DECEMBER		
132 Witham and Braintree	Single BLOCKED	23 40 Mon to Fri to 05 30 Tue to Sat. Bridgework (No.2102B). Mechanical equipment in use. <u>Isolation of electrical sections 379.</u>
<u>COLCHESTER TO CLACTON</u>		
SATURDAY/SUNDAY 29/30 AND SUNDAY 30 NOVEMBER		
133 Colchester Station and Manningtree Station/East Gate Jn	Up Main and Clacton Single BLOCKED Down Main BLOCKED	23 40 Sat to 06 00)Track maintenance,)earthwork and)loading materials. 00 35 to 07 30 Sun)Mechanical)equipment in use.) <u>23 40 Sat to 06 00</u>) <u>Isolation of</u>) <u>electrical sections</u>) <u>339AK, 341BC.</u>) <u>00 35 to 07 30 Sun</u>) <u>Possession to be</u>) <u>given up for</u>) <u>passage of 1Y02</u>) <u>02 20 Liverpool</u>) <u>Street to</u>) <u>Stowmarket over</u>) <u>Down Main line.</u>

SECTION B - TEMPORARY ENGINEERING WORKS - continued

At or between	Lines affected	Remarks
<u>COLCHESTER TO CLACTON - continued</u>		
MONDAY 1 TO WEDNESDAY 3 DECEMBER		
134 Thorpe-le-Soken and Colchester Jn	Up BLOCKED to electric trains	23 40 Mon and Tue to 04 45 Tue and Wed. In connection with engineering work between East Gate Jn. and Thorpe-le-Soken. <u>Isolation of electrical sections 381, 383BCD.</u>
MONDAY 1 TO FRIDAY 5 DECEMBER		
135 East Gate Jn and Thorpe-le-Soken	Down and Up BLOCKED	23 40 Mon to Thu to 04 45 Tue to Fri. Track maintenance and trimming lineside vegetation. Mechanical equipment in use. <u>Possession to be given up for passage of Freight trains to/from Hythe.</u>
WEDNESDAY 3 TO FRIDAY 5 DECEMBER		
136 Thorpe-le-Soken and Hythe	Up BLOCKED to electric trains	23 40 Wed and Thu to 04 45 Thu and Fri. In connection with engineering work between East Gate Jn. and Thorpe-le-Soken. <u>Isolation of electrical sections 381A, 383BC.</u>
<u>EAST GATE JN. TO ST. BOTOLPHS</u>		
MONDAY 1 TO WEDNESDAY 3 DECEMBER		
137 East Gate Jn and St. Botolphs	All BLOCKED to electric trains	23 40 Mon and Tue to 04 45 Tue and Wed. In connection with engineering work between East Gate Jn. and Thorpe-le-Soken. <u>Isolation of electrical sections 381.</u>
<u>COLNE JN TO HYPHE JN</u>		
MONDAY 1 TO WEDNESDAY 3 DECEMBER		
138 Colne Jn and Hythe Jn	Down and Up BLOCKED to electric trains	23 40 Mon and Tue to 04 45 Tue and Wed. In connection with engineering work between East Gate Jn. and Thorpe-le-Soken. <u>Isolation of electrical sections 381.</u>

SECTION B - TEMPORARY ENGINEERING WORKS - continued

At or between	Lines affected	Remarks
<u>THORPE-LE-SOKEN TO WALTON-ON-NAZE</u>		
FRIDAY/SATURDAY 28/29 NOVEMBER		
139 Thorpe-le-Soken and Walton-on-Naze	Single BLOCKED	23 59 to 05 00. Overhead line work. Mechanical equipment in use. <u>Isolation of electrical sections 387.</u>
SATURDAY/SUNDAY 29/30 NOVEMBER		
140 Thorpe-le-Soken and Walton-on-Naze	Single BLOCKED	23 55 to 07 30. Track renewal and unloading rails. 67½ and 67½mp. Mechanical equipment in use.
<u>MANNINGTREE SOUTH JN TO HARWICH</u>		
UNTIL FURTHER NOTICE		
141 Wrabness and Mistley	Up	07 30 to 17 00. Earthwork. 64m. 46chs. and 64m. 15chs. Mechanical equipment in use. (85/65)
SATURDAY/SUNDAY 29/30 NOVEMBER		
142 Parkeston Goods Jn Parkeston East LC	All BLOCKED	23 20 to 06 45. Track maintenance and unloading materials. Mechanical equipment in use.
MONDAY 1 TO THURSDAY 4 DECEMBER		
143 Wrabness and Manningtree East Jn	Up BLOCKED	23 30 Mon to Wed to 04 45 Tue to Thu. Track maintenance. Mechanical equipment in use. <u>Single line working over Down line.</u>
MONDAY 1 TO SATURDAY 6 DECEMBER		
144 Manningtree South Jn and Harwich Town	All BLOCKED electric trains	23 45 Mon to Fri to 04 30 Tue to Sat. In connection with engineering work between Wrabness and Harwich Town. <u>Isolation of electrical sections 391 and 392.</u>

SECTION B - TEMPORARY ENGINEERING WORKS - continued

At or between	Lines affected	Remarks
---------------	-------------------	---------

MANNINGTREE SOUTH JN TO HARWICH - continued

MONDAY 1 TO SATURDAY 6 DECEMBER - continued

145 Wrabness and Harwich Town	All BLOCKED	23 35 Mon to Fri to 05 15 Tue to Sat. Overhead line work, track maintenance and unloading materials. Mechanical equipment in use. <u>Possession to be given up for passage of Diesel trains.</u>
-------------------------------------	----------------	---

EAST SUFFOLK JN TO OULTON BROAD NORTH JN

UNTIL FURTHER NOTICE

146 Westerfield Jn and Woodbridge	Down and Up BLOCKED	07 00 to 19 00. Bridgework (No.418A). 76m. 65chs. Mechanical equipment in use. <u>Possession to be given up for passage of trains.</u> (86/33)
--------------------------------------	------------------------	---

SATURDAY/SUNDAY 29/30 NOVEMBER

147 Westerfield and Woodbridge	Down BLOCKED Up BLOCKED	23 10 to 10 00)Track renewal,)track maintenance and 23 10 to 16 00)loading rails.)Mechanical equipment)in use. <u>10 00 to 16 00</u>) <u>Sun. Single line</u>) <u>working over Down</u>) <u>line.</u>
-----------------------------------	----------------------------------	--

WESTERFIELD JN TO FELIXSTOWE

UNTIL FURTHER NOTICE

148 Westerfield Jn and Derby Road	Single	08 00 to 16 00. Earthwork. 73m. 13chs. and 73 ¹ / ₂ m.p. (85/61)
149 Derby Road and Felixstowe Beach Jn	Single	07 30 to 17 00. Earthwork. 82 ³ / ₄ and 83m.p. Mechanical equipment in use. (86/1)

SECTION B - TEMPORARY ENGINEERING WORKS - continued

At or between	Lines affected	Remarks
---------------	----------------	---------

WESTERFIELD JN TO FELIXSTOWE - continued

SATURDAY/SUNDAY 29/30 NOVEMBER

150 Derby Road and Felixstowe Beach Jn	Single BLOCKED	22 30 to 16 00. Track maintenance. Mechanical equipment in use.
--	-------------------	---

NORWICH TO LOWESTOFT

UNTIL FURTHER NOTICE

151 Norwich Station and Trowse Lower Jn	All <u>Between Trains</u>	07 00 to 17 00. Construction work (overhead line), earthwork, track maintenance and signalling work. Points and signals disconnected. (86/7)
---	------------------------------	---

SATURDAY 29 TO SUNDAY 30 NOVEMBER

152 Swainsthorpe LC/ Hethersett and Norwich Station	All	07 00 Sat to 22 00 Sun. Signalling work and track renewal. Points and signals disconnected. (See Section 'C').
---	-----	---

SATURDAY/SUNDAY 29/30 NOVEMBER

153 Norwich and Whitlingham Jn	'A' and 'E' lines/Down and Up Lowestoft/ Main BLOCKED)23 15 to 07 00. Construction work (overhead line) and loading materials. <u>Possession to be given up for passage of trains.</u>
Norwich Station	Platforms 1, 2 and 3 (and approaches) and Platforms 4, 5 and 6 BLOCKED	

SUNDAY 30 NOVEMBER TO FRIDAY 5 DECEMBER

154 Trowse Swing Bridge and Norwich Station	'C' Line BLOCKED 'D' and 'W' lines <u>Between Trains</u>	23 45 Sun to Thu to 05 00 Mon to Fri. Construction work (overhead line).
---	---	--

SECTION B - TEMPORARY ENGINEERING WORKS - continued

At or between	Lines affected	Remarks
---------------	----------------	---------

NORWICH TO LOWESTOFT - continued

SUNDAY 30 NOVEMBER TO FRIDAY 5 DECEMBER - continued

155	Norwich and Whitlingham Jn	'A' and 'E' lines/Down and Up Lowestoft/ Main BLOCKED)23 30 Sun to Thu to 05 00 Mon to Fri.)Construction work (overhead line).) <u>Possession to be given up for passage</u>)of trains.))
	Norwich Station	Platforms 4, 5 and 6 BLOCKED)))

THURSDAY/FRIDAY 4/5 DECEMBER

156	Whitlingham Jn and Cantley	Down and Up BLOCKED	23 40 to 05 15. Track maintenance. Mechanical equipment in use.
-----	-------------------------------	------------------------	--

WHITLINGHAM JN TO CROMER

UNTIL FURTHER NOTICE

157	Whitlingham Jn and Wroxham	Down and Up	07 30 to 16 30. Bridgework (No. 365). 3m. 48chs. (86/6)
158	Cromer Station	Platforms 1 and 2	Platform work. (86/15)

CROMER TO SHERINGHAM

UNTIL FURTHER NOTICE

159	Cromer Station	Platforms 1 and 2	Platform work. (86/15)
-----	----------------	----------------------	---------------------------

BRUNDALL JN TO YARMOUTH VIA ACLE

UNTIL FURTHER NOTICE

160	Brundall Jn and Yarmouth	All	08 00 to 16 00. Signalling work. (86/30)
-----	-----------------------------	-----	---

SECTION B - TEMPORARY ENGINEERING WORKS - continued

<u>At or between</u>	<u>Lines</u>	<u>Remarks</u>
	<u>affected</u>	

BRUNDALL JN TO YARMOUTH VIA ACLE - continued

SATURDAY/SUNDAY 29/30 NOVEMBER

161	Brundall Jn and Acle	Single BLOCKED	23 25 to 16 00. Level crossing road repairs (Chapel Road LC). Crane and mechanical equipment in use.
-----	-------------------------	-------------------	--

REEDHAM JN TO YARMOUTH

UNTIL FURTHER NOTICE

162	Reedham Jn and Yarmouth	All	08 00 to 16 00. Signalling work. (86/30)
-----	----------------------------	-----	---

BETHNAL GREEN JN TO KING'S LYNN

UNTIL FURTHER NOTICE

163	Cambridge Heath Station	Down and Up Suburban	08 00 to 17 00. Platform work. 1m. 61chs. Mechanical equipment in use. (<u>See Section 'D'</u>). (86/24)
164	London Fields Station	Down and Up Suburban	Platform work. 2m. 35chs. Mechanical equipment in use. (<u>See Section 'D'</u>). (86/27)
165	Enfield Lock Station	Up	08 00 to 16 30. Platform work. 11m. 65chs. Mechanical equipment in use. (86/28)
166	Enfield Lock and Waltham Cross	Down and Up	07 00 to 18 00. Bridgework (No.1418C). 12m. 34chs. Crane and mechanical equipment in use. (85/59)
167	Bishops Stortford (Country end) and Stansted	Down and Up Main BLOCKED to electric trains	Overhead line work. <u>Isolation of electrical sections 427, 428 (buffer section).</u> (85/41)
168	Bishops Stortford and Cambridge (North)	All	07 00 to 18 00. Construction work (overhead line). Mechanical equipment in use. (85/21)
169	Bishops Stortford and Chesterton Jn	All	08 00 to 18 00. Signalling work. (86/35)

SECTION B - TEMPORARY ENGINEERING WORKS - continued

At or between	Lines affected	Remarks
---------------	----------------	---------

BETHNAL GREEN JN TO KING'S LYNN - continued

UNTIL FURTHER NOTICE - continued

170	Whittlesford Station	Down and Up	Platform work. 49m. 02chs. Mechanical equipment in use. (86/29)
171	Chesterton Jn and Milton Fen LC	Down and Up	07 30 to 18 00. Bridgework (No. 1550B). 58m. 63chs. Mechanical equipment in use. (86/24)

SATURDAY 29 NOVEMBER

172	Clapton Jn and Cheshunt Jn	Down and Up Main BLOCKED to electric trains	00 01 to 04 30. In connection with engineering work between Tottenham South Jn and Cheshunt Jn. <u>Isolation of electrical sections 411 and 412.</u> <u>Electric trains diverted via Southbury.</u>
173	Tottenham South Jn and Cheshunt Jn	Down and Up Main BLOCKED	00 01 to 04 30. Overhead line work and bridgework (No.1418C). Mechanical equipment in use. <u>Possession to be given up for passage of Diesel trains. Electric trains diverted via Southbury.</u>
174	Coldham Lane Jn and Waterbeach	All <u>Between Trains</u>	07 00 to 16 00. Bridgework (Nos.1547, 1548, 1548A, 1549 and 1550A).

SATURDAY/SUNDAY 29/30 NOVEMBER

175	Bishops Stortford (London End) and Stansted	Platform 1 and Down and Up Main BLOCKED to electric trains	18 00 to 10 00. In connection with engineering work between Bishops Stortford and Audley End. <u>Isolation of electrical sections 417AB, 418C, 427 and 428.</u>
176	Bishops Stortford and Audley End	Up Main BLOCKED Down Main BLOCKED	22 30 to 08 30) Construction work) (overhead line) and 23 50 to 09 00) track maintenance. 30%) and 35% m.p. Mechanical) equipment in use.) <u>Possession to be given</u>) <u>up for passage of 1P04</u>) <u>02 10 Liverpool Street</u>) <u>to Yarmouth and 1H02</u>) <u>03 10 Liverpool Street</u>) <u>to King's Lynn over</u>) <u>Down Main line.</u>

SECTION B - TEMPORARY ENGINEERING WORKS - continued

At or between	Lines affected	Remarks
---------------	----------------	---------

BETHNAL GREEN JN TO KING'S LYNN - continuedSATURDAY/SUNDAY 29/30 NOVEMBER - continued

177	Audley End and Great Chesterford	Up BLOCKED Down BLOCKED	22 30 to 08 15) 23 45 to 09 00)	Earthwork and trimming lineside vegetation. 42 and 45 $\frac{1}{2}$ m.p. Mechanical equipment in use. Possession to be given up for passage of 1P04 02 10 Liverpool Street to Yarmouth and 1H02 03 10 Liverpool Street to King's Lynn over Down line.
178	Shepreth Branch Jn and Coldham Lane Jn	All <u>Between Trains</u>	22 00 to 08 00.	Construction work. (overhead line). 53 $\frac{1}{2}$ and 56 $\frac{1}{2}$ m.p. Mechanical equipment in use.

SATURDAY/SUNDAY 29/30 AND SUNDAY 30 NOVEMBER

179	Whittlesford Crossovers and Shepreth Branch Jn	Up BLOCKED Down BLOCKED	22 20 Sat to 08 15) 00 05 to 09 00 Sun)	Construction work (overhead line) and earthwork 49 $\frac{1}{2}$ and 53m.p. Mechanical equipment in use. Possession to be given up for passage of 1P04 02 10 Liverpool Street to Yarmouth and 1H02 03 10 Liverpool Street to King's Lynn over Down line.
-----	---	----------------------------------	--	--

SUNDAY 30 NOVEMBER

180	Bethnal Green Station (Country End)	Down and Up Fast and Up Suburban	08 00 to 16 00.	Signalling work (No. 62 points).
-----	---	-------------------------------------	-----------------	-------------------------------------

SECTION B - TEMPORARY ENGINEERING WORKS - continued

At or between	Lines affected	Remarks
---------------	----------------	---------

BETHNAL GREEN JN TO KING'S LYNN - continued

SUNDAY 30 NOVEMBER - continued

181	Great Chesterford and Whittlesford Crossovers	Down Main BLOCKED Up Main BLOCKED	00 10 to 08 15) Track maintenance and platform work 00 10 to 16 00)(Whittlesford Station).)4m.p. and 49m. 02chs.)Mechanical equipment in use. <u>00 10 to 08 15</u>) <u>Possession to be given up for passage of 1P04</u>) <u>02 10 Liverpool Street to Yarmouth and 1H02</u>) <u>03 10 Liverpool Street to King's Lynn over Down Main line.</u>) <u>08 15 to 16 00.</u>) <u>Single line working over Down Main line.</u>
182	Cambridge	Down and Up Goods and Up Main/ Through line <u>Between Trains</u>	08 00 to 16 00. Loading materials. 55% and 56% m.p.

SUNDAY/MONDAY 30 NOVEMBER/1 DECEMBER

183	Shepreth Branch Jn and Cambridge (South)	Down Main and Down Goods Loop South BLOCKED	23 00 to 05 30. Construction work (overhead line). 53% and 55% m.p. Mechanical equipment in use. <u>Single line working over Up Main line.</u>
-----	--	--	--

MONDAY 1 DECEMBER

184	Cheshunt Jn (London End) and Broxbourne Jn (Country End)	All BLOCKED to electric trains	00 40 to 03 50. In connection with overhead line work. <u>Isolation of electrical sections 413 and 414.</u>
185	Cheshunt Station	All BLOCKED	00 40 to 03 50. Overhead line work. <u>Possession to be given up for passage of Diesel trains.</u>

SECTION B - TEMPORARY ENGINEERING WORKS - continued

At or between	Lines affected	Remarks
---------------	----------------	---------

BETHNAL GREEN JN TO KING'S LYNN - continued

MONDAY 1 DECEMBER - continued

186	Audley End and Great Chesterford	Down BLOCKED	09 25 to 15 20. Construction work (overhead line) 41½ and 45½m.p. <u>Single line working over Up line.</u>
187	Shepreth Branch Jn and Coldham Lane Jn	All <u>Between Trains</u>	08 00 to 16 00. Construction work (overhead line). 53% and 56% <u>m.p.</u> Mechanical equipment in use.

MONDAY/TUESDAY 1/2 DECEMBER

188	Littleport and Downham Market	Single BLOCKED	23 00 to 05 00. Track maintenance 76 and 86m.p. Mechanical equipment in use.
-----	-------------------------------	-------------------	--

MONDAY 1 TO WEDNESDAY 3 DECEMBER

189	Bishops Stortford and Spelbrook	Up Main BLOCKED	22 50 Mon and Tue to 05 15 Tue and Wed
		Up Passenger Loop (London End) BLOCKED	00 30 to 04 45 Tue and Wed
)Overhead line work and track maintenance.)Mechanical equipment in use.) <u>Single line working over Down Main line.</u>) <u>00 30 to 04 45 Tue and Wed</u>) <u>Isolation of electrical sections 417EF.</u>

MONDAY 1 TO FRIDAY 5 DECEMBER

190	Shepreth Branch Jn and Coldham Lane Jn	All <u>Between Trains</u>	22 00 Mon to Thu to 16 00 Tue to Fri. Construction work (overhead line). 53% and 56% <u>m.p.</u> Mechanical equipment in use.
-----	--	------------------------------	---

TUESDAY 2 AND WEDNESDAY 3 DECEMBER

191	Stansted and Bishops Stortford	Up Main BLOCKED	09 25 to 15 20 daily. Construction work (overhead line). 33% and 30% <u>m.p.</u> <u>Single line working over Down Main line.</u>
-----	--------------------------------	--------------------	---

SECTION B - TEMPORARY ENGINEERING WORKS - continued

At or between	Lines affected	Remarks
<u>BETHNAL GREEN JN TO KING'S LYNN - continued</u>		
WEDNESDAY/THURSDAY 3/4 DECEMBER		
192 Bishops Stortford (London End) and Stansted	Down Main BLOCKED	23 30 to 04 50. Track maintenance and overhead line work. Mechanical equipment in use. <u>Single line working over Up Main line.</u> 23 30 to 04 45 Isolation of electrical sections 418C, 428.
193 Whittlesford Crossovers and Great Chesterford	Up Main BLOCKED	22 10 to 04 00. Track maintenance. 46 ³ / ₄ and 46m.p. Mechanical equipment in use. <u>Single line working over Down Main line.</u>
THURSDAY/FRIDAY 4/5 DECEMBER		
194 Stansted and Bishops Stortford	Up Main BLOCKED	22 45 to 05 15. Track maintenance and overhead line work. Mechanical equipment in use. <u>Single line working over Down Main line.</u> 23 30 to 04 45. Isolation of electrical sections 417AB, 427.
THURSDAY 4 DECEMBER		
195 Bishops Stortford and Stansted	Down Main BLOCKED	09 15 to 14 45. Construction work (overhead line) 30% and 33 ¹ / ₄ m.p. <u>Single line working over Up Main line.</u>
FRIDAY 5 DECEMBER		
196 Bishops Stortford and Stansted	Down Main BLOCKED	09 15 to 15 10. Construction work (overhead line). 30% and 33 ¹ / ₄ m.p. <u>Single line working over Up Main line.</u>
FRIDAY/SATURDAY 5/6 DECEMBER		
197 Stansted and Bishops Stortford	Up Main BLOCKED	23 00 to 04 45. Overhead line work. Mechanical equipment in use. <u>Isolation of electrical sections 417AB, 427. Single line working over Down Main line.</u>

SECTION B - TEMPORARY ENGINEERING WORKS - continued

<u>At or between</u>	<u>Lines affected</u>	<u>Remarks</u>
----------------------	-----------------------	----------------

READING LANE JN TO NAVARINO ROAD JN (GRAHAM ROAD CURVE)

SUNDAY 30 NOVEMBER

198	Reading Lane Jn and Navarino Road Jn	Single BLOCKED to electric trains	00 01 to 08 00. In connection with engineering work between Dalston Western Jn and Lea Jn. <u>Isolation of electrical sections 314C.</u>
-----	--------------------------------------	---	--

HACKNEY DOWNS NORTH JN. TO ENFIELD TOWN

SUNDAY 30 NOVEMBER

199	Seven Sisters and Enfield Town/Cheshunt Jn	All BLOCKED	00 05 to 22 00. Formation renewal track maintenance, track renewal, overhead line work and painting White Hart Lane Station. Mechanical equipment in use. <u>Trains diverted via Clapton. 00 05 to 20 00</u> <u>Isolation of electrical sections 401AB, 402DEF, 403 and 404.</u>
-----	--	----------------	---

TUESDAY 2 TO THURSDAY 4 DECEMBER

200	Seven Sisters and Enfield Town/Cheshunt Jn	All BLOCKED	00 05 to 04 35 daily. Track maintenance. 8½ and 9m.p. <u>Trains diverted via Clapton.</u>
-----	--	----------------	---

BURY STREET JN TO CHESHUNT

SUNDAY 30 NOVEMBER

201	Seven Sisters and Enfield Town/Cheshunt Jn	All BLOCKED	00 05 to 22 00. Formation renewal track maintenance, track renewal, overhead line work and painting White Hart Lane Station. Mechanical equipment in use. <u>Trains diverted via Clapton. 00 05 to 20 00</u> <u>Isolation of electrical sections 401AB, 402DEF, 403 and 404.</u>
-----	--	----------------	---

SECTION B - TEMPORARY ENGINEERING WORKS - continued

At or between	Lines affected	Remarks
---------------	----------------	---------

BURY STREET JN TO CHESHUNT - continued

MONDAY 1 DECEMBER

202	Bury Street Jn and Cheshunt Jn	Down and Up BLOCKED	00 40 to 03 50. Overhead line work. <u>Isolation of electrical sections 405 and 406.</u>
-----	--------------------------------	------------------------	--

TUESDAY 2 TO THURSDAY 4 DECEMBER

203	Seven Sisters and Enfield Town/Cheshunt Jn	All BLOCKED	00 05 to 04 35 daily. Track maintenance. 8½ and 9m.p. <u>Trains diverted via Clapton.</u>
-----	--	----------------	---

BROXBOURNE JN TO HERTFORD EAST

UNTIL FURTHER NOTICE

204	Rye House and St. Margarets	Down and Up	08 00 to 18 00. Bridgework (No. 2035A). 19m. 66chs. Mechanical equipment in use. (85/60)
-----	-----------------------------	-------------	---

SUNDAY 30 NOVEMBER

205	Broxbourne Jn and Hertford East	All BLOCKED	00 30 to 06 30. Bridgework (No.2035A). 19m 66chs. Crane and mechanical equipment in use. <u>Isolation of electrical sections 434 and 435.</u>
-----	---------------------------------	----------------	---

MONDAY 1 DECEMBER

206	Broxbourne Jn and St. Margarets	Down and Up BLOCKED to electric trains	00 40 to 03 50. In connection with overhead line work. <u>Isolation of electrical sections 414.</u>
-----	---------------------------------	---	---

COLDHAM LANE JN TO HAUGHLEY JN

UNTIL FURTHER NOTICE

207	Bury St. Edmunds Station	Down	08 00 to 15 00. Repairs to platform awnings. (86/18)
-----	--------------------------	------	---

SECTION B - TEMPORARY ENGINEERING WORKS - continued

<u>At or between</u>	<u>Lines</u>	<u>Remarks</u>
	<u>affected</u>	

ELY NORTH JN TO PETERBOROUGH, CRESCENT JN

UNTIL FURTHER NOTICE

208	Black Bank and Crescent Jn	All	06 00 to 16 00.	Signalling work. (86/35)
-----	-------------------------------	-----	-----------------	-----------------------------

SATURDAY 29 TO SUNDAY 30 NOVEMBER

209	Chettisham and Manea	Down BLOCKED Up BLOCKED	11 30 Sat to 18 00 Sun)	Bridgework (Nos. 1813 and 1814) 78 and 78½m.p. Crane and mechanical equipment in use. 14 00 to 18 00 Sun. Single line working over Up line.
-----	-------------------------	----------------------------------	-------------------------	---

SUNDAY 30 NOVEMBER

210	Whittlesea and Kings Dyke	Down and Up	07 00 to 17 00.	Signalling work.
-----	------------------------------	-------------	-----------------	------------------

THURSDAY 4 DECEMBER

211	Manea and Chettisham	Up BLOCKED	00 01 to 05 00.	Bridgework (Nos. 1813 and 1814). 78½ and 78m.p. <u>Single line working over Down line.</u>
-----	-------------------------	---------------	-----------------	---

ELY NORTH JN TO TROWSE LOWER JN

UNTIL FURTHER NOTICE

212	Thetford and Lakenheath	Up	08 00 to 16 00.	Track maintenance. 87½ and 85½m.p. (86/24)
213	Wymondham and Hethersett	Down and Up <u>Between Trains</u>	07 30 to 18 00.	Bridgework, earthwork and construction work. 115m. 65chs. and 117m. 69chs. Cranes and mechanical equipment in use. (86/18)
214	Wymondham and Trowse Lower Jn	Down and Up	07 30 to 16 00.	Signalling work. (85/24)

SECTION B - TEMPORARY ENGINEERING WORKS - continued

At or between	Lines affected	Remarks
---------------	----------------	---------

ELY NORTH JN TO TROWSE LOWER JN - Continued

UNTIL FURTHER NOTICE - continued

- | | | | |
|-----|--------------------------------|-------------|---|
| 215 | Hethersett and Trowse Lower Jn | Down and Up | 07 30 to 16 00. Bridgework (Nos.1638, 1640, 1640A and 349). 121m. 17chs. and 122m. 32chs.
<u>Until 16 00 Saturday 29 November.</u>
(86/22) |
| 216 | Hethersett and Trowse Lower Jn | Down and Up | 07 30 to 16 00. Bridgework (Nos. 1638, 1640, 1640A and 349). 121m 17chs. and 122m 32chs. and track renewal.
<u>From 07 30 Sunday 30 November.</u>
(86/36) |

SATURDAY 29 TO SUNDAY 30 NOVEMBER

- | | | | |
|-----|--|-----|--|
| 217 | Swainsthorpe LC/Lakenham and Norwich Station | All | 07 00 Sat to 22 00 Sun. Signalling work and track renewal. Points and signals disconnected.
<u>(See Section 'C').</u> |
|-----|--|-----|--|

SATURDAY/SUNDAY 29/30 NOVEMBER

- | | | | |
|-----|--------------------------|------------------------|---|
| 218 | Wymondham and Hethersett | Down and Up
BLOCKED | 23 00 to 07 00. Reballasting 114m 15chs and 114 $\frac{1}{2}$ m.p. Mechanical equipment in use. <u>Possession to be given up for passage of trains.</u> |
|-----|--------------------------|------------------------|---|

SATURDAY/SUNDAY 29/30 AND SUNDAY 30 NOVEMBER

- | | | | |
|-----|--------------------------------|--|---|
| 219 | Hethersett and Trowse Lower Jn | Up
BLOCKED
Down
BLOCKED
Down and Up
<u>Between Trains</u> | 21 15 Sat to 07 00)Track renewal.
)Crane and
22 00 Sat to 07 00)mechanical
)equipment' in use.
07 00 to 12 00 Sun) <u>Possession to be given up for passage of 2P64</u>
<u>21 20 Cambridge to Norwich and 1P04</u>
<u>02 10 Liverpool Street to Yarmouth over Up line under single line</u>
<u>working. (See Section 'C').</u> |
|-----|--------------------------------|--|---|

SECTION B - TEMPORARY ENGINEERING WORKS - continued

At or between	Lines affected	Remarks
---------------	-------------------	---------

ELY NORTH JN TO TROWSE LOWER JN - continued

FRIDAY 5 DECEMBER

220 Ely North Jn and Shippea Hill	Down BLOCKED	00 01 to 06 00. Track maintenance, 72 and 77 m.p. Mechanical equipment in use.
---	-----------------	--

WYMONDHAM TO NORTH ELMHAM

UNTIL FURTHER NOTICE

221 Wymondham and North Elmham	Single	08 00 to 16 00. Trimming lineside vegetation. ¼ and 6m.p. Mechanical equipment in use. (85/31)
-----------------------------------	--------	---

FENCHURCH STREET TO SHOE BURYNNESS

UNTIL FURTHER NOTICE

222 Fenchurch Street Station	All	Construction/demolition work. Mechanical equipment in use. (84/38)
223 Fenchurch Street and Stepney East	All	Construction work, and in connection with engineering work (Docklands Light Railway). Mechanical equipment in use. <u>(See Section 'D')</u> . (86/25)
224 Fenchurch Street and Gas Factory Jn	All	08 00 to 17 00. Signalling work. (86/1)
225 East Ham	Down and Up	Construction work. Mechanical equipment in use. (83/51)
226 East Ham and Barking (London End)	Down and Up	Erecting scaffolding in connection with bridge No. 66B. (85/8)
227 Leigh-on-Sea and Benfleet	Up	Sea wall work. (85/34)

SECTION B - TEMPORARY ENGINEERING WORKS - continued

At or between	Lines affected	Remarks
---------------	----------------	---------

FENCHURCH STREET TO SHOEBURYNESS - Continued

UNTIL FURTHER NOTICE - continued

228 Leigh-on-Sea	Down	09 00 to 16 00. Demolition work. Mechanical equipment in use. (85/60)
229 Westcliff-on-Sea	Down	09 00 to 16 00. Demolition work. Mechanical equipment in use. (85/60)

FRIDAY/SATURDAY 28/29 NOVEMBER

230 Fenchurch Street and Gas Factory Jn	All BLOCKED	21 15 to 06 00. Repairs to platform awnings (Stepney East Station), construction work and painting Stepney East Station. <u>Isolation of electrical sections 501, 502, 503 and 504.</u>
---	----------------	---

SATURDAY 29 NOVEMBER

231 Upminster and Pitsea	Down and Up BLOCKED	01 15 to 04 25. Overhead line work. Mechanical equipment in use. <u>Isolation of electrical sections 517, 518, 519 and 520. Trains diverted via Grays.</u>
--------------------------	------------------------	--

SATURDAY/SUNDAY 29/30 AND SUNDAY 30 NOVEMBER

232 Southend Central (London End) and Shoeburyness	Up Main BLOCKED Down Main and Platforms 1 and 2 BLOCKED	23 30 Sat to 23 00 Sun) Repairs to platform awnings and painting Southend Central and Thorpe Bay stations, and track maintenance. 01 45 to 23 00 Sun) <u>Isolation of electrical sections 527. Access available to/from Platforms 3 and 4 at Southend Central. 01 45 to 23 00 Sun.</u> <u>Isolation of electrical sections 526BC, 528.</u>
--	--	--

SECTION B - TEMPORARY ENGINEERING WORKS - continued

<u>At or between</u>	<u>Lines affected</u>	<u>Remarks</u>
----------------------	-----------------------	----------------

FENCHURCH STREET TO SHOEBURYNESSE - continued

SUNDAY 30 NOVEMBER

234	Gas Factory Jn and East Ham (London End)	Down and Up BLOCKED	01 00 to 06 15. Track maintenance 4 and 4½ m.p. Mechanical equipment in use.
235	Upminster and Laindon	Up BLOCKED Down BLOCKED	01 20 to 06 00)Overhead line work. 01 20 to 06 00. 01 20 to 18 00)Isolation of electrical sections 517. 01 20 to 18 00. Isolation of electrical sections 518. 06 00 to 18 00 Single line working over Up line.

MONDAY 1 DECEMBER

236	Barking and Pitsea	All BLOCKED to electric trains	01 25 to 04 15. In connection with overhead line work between Upminster and Pitsea. <u>Isolation of electrical sections 514, 515, 517 and 518.</u> <u>Electric trains diverted via Grays.</u>
237	Upminster and Pitsea	Down and Up BLOCKED	01 25 to 04 15. Overhead line work. <u>Trains diverted via Grays.</u>

MONDAY 1 TO FRIDAY 5 DECEMBER

238	Laindon	Platform 2 (Reversing Line) BLOCKED	10 00 to 16 00 daily. Painting Laindon Station. <u>Trains to be replatformed as necessary.</u>
-----	---------	---	---

TUESDAY 2 TO FRIDAY 5 DECEMBER

239	Upminster and Laindon (London End)	Down and Up BLOCKED	01 15 to 04 25 daily. Overhead line work. Mechanical equipment in use. <u>Trains diverted via Grays.</u>
240	Upminster and Pitsea Jn	All BLOCKED to electric trains	01 15 to 04 25 daily. In connection with engineering work. <u>Isolation of electrical sections 517, 518, 519, 520, 521E, 522A.</u> <u>Electric trains diverted via Grays.</u>

SECTION B - TEMPORARY ENGINEERING WORKS - continued

<u>At or between</u>	<u>Lines affected</u>	<u>Remarks</u>
----------------------	-----------------------	----------------

FENCHURCH STREET TO SHOEBURYNNESS - continued

TUESDAY 2 TO FRIDAY 5 DECEMBER - continued

241	Laindon (London End) and Pitsea Jn	All BLOCKED	01 15 to 04 25 daily. Painting Laindon, Basildon and Pitsea Stations. <u>Trains diverted via Grays.</u>
-----	--	----------------	---

WEDNESDAY 3 TO FRIDAY 5 DECEMBER

242	Shoeburyness and Southend Central	Up BLOCKED	23 15 Wed and Thu to 04 00 Thu and Fri. Track maintenance and loading materials. 36m. 42chs. and 36m. 26chs.
-----	---	---------------	---

GAS FACTORY JN TO BOW JN

FRIDAY 28 NOVEMBER TO MONDAY 1 DECEMBER

243	Gas Factory Jn and Bow Jn	Single BLOCKED	23 00 Fri to 05 00 Mon. In connection with engineering work between Bethnal Green and Stratford. <u>Isolation of electrical sections 309A.</u>
-----	------------------------------	-------------------	--

UPPER HOLLOWAY TO BARKING, TILBURY LINE JN WEST

UNTIL FURTHER NOTICE

244	Upper Holloway and Crouch Hill Station	Down and Up	Earthwork. 3m 41chs. and 3m 43chs. Mechanical equipment in use. (85/64)
245	Wanstead Park Station	Up	08 00 to 16 00. Platform work. <u>(See Section 'D').</u> (85/50)
246	Woodgrange Park and Barking Station Jn	Down and Up <u>Between Trains</u>	07 30 to 18 00. Bridgework (No. 6). 12m. 26chs. Crane and mechanical equipment in use. (85/62)
247	Woodgrange Park and Barking Tilbury Line Jn West	Down and Up	Erecting scaffolding in connection with bridge No. 14A. (85/8)

SECTION B - TEMPORARY ENGINEERING WORKS - continued

At or between	Lines affected	Remarks
---------------	----------------	---------

UPPER HOLLOWAY TO BARKING, TILBURY LINE JN WEST - continued

SUNDAY 30 NOVEMBER

248	Upper Holloway and Harringay Park Jn	Down and Up BLOCKED	09 00 to 17 00. Track maintenance (Crouch Hill).
249	South Tottenham East Jn and Woodgrange Park Jn	Down and Up BLOCKED	00 01 to 18 00. Overhead line work and unloading rails and materials. Mechanical equipment in use.
250	Forest Gate Jn and Barking Tilbury Line Jn West	Down and Up BLOCKED	00 50 to 18 00. Track maintenance, undertrack excavation, bridgework (No.14A) and overhead line work. Crane and mechanical equipment in use. <u>12 00 to 18 00 Possession to be given up for passage of Engineers' trains.</u>

SUNDAY 30 NOVEMBER TO MONDAY 1 DECEMBER

251	Forest Gate Jn and Barking Tilbury Line Jn West	Down and Up BLOCKED to electric trains	00 50 Sun to 04 00 Mon. In connection with engineering work. <u>Isolation of electrical sections 512AB, 513EF.</u>
-----	---	---	--

SUNDAY/MONDAY 30 NOVEMBER/1 DECEMBER

252	Woodgrange Park Jn and Barking Tilbury Line Jn West	Down and Up BLOCKED	18 00 to 04 00. Bridgework (No. 14A). Crane and mechanical equipment in use. <u>Possession to be given up for passage of Engineers' trains.</u>
-----	---	------------------------	---

BARKING, TILBURY LINE JN EAST TO TILBURY RIVERSIDE

UNTIL FURTHER NOTICE

253	Dagenham Dock Station	Down and Up	08 00 to 17 00. Construction work. Mechanical equipment in use. (85/14)
254	Rainham Station	Down and Up	08 00 to 17 00. Construction work. Mechanical equipment in use. (85/14)
255	Purfleet Station	Down and Up	09 00 to 16 00. Platform work. Mechanical equipment in use. (85/61)

SECTION B - TEMPORARY ENGINEERING WORKS - continued

<u>At or between</u>	<u>Lines / affected</u>	<u>Remarks</u>
----------------------	-----------------------------	----------------

BARKING, TILBURY LINE JN EAST TO TILBURY RIVERSIDE - continued

SUNDAY 30 NOVEMBER

256	Barking Tilbury Down Main Line Jn East and West Thurrock Jn	BLOCKED	00 45 to 06 15. Track maintenance. Mechanical equipment in use.
-----	---	---------	--

TILBURY RIVERSIDE TO PITSEA

SATURDAY/SUNDAY 29/30 NOVEMBER

257	Stanford-le-Hope and Pitsea	Down and Up BLOCKED	23 55 to 21 40. Track maintenance, track renewal and overhead line work. Mechanical equipment in use. <u>Isolation of electrical sections</u> <u>536CD, 537AB.</u>
-----	--------------------------------	------------------------	--

SUNDAY 30 NOVEMBER

258	Tilbury East Jn and Stanford-le-Hope	Down and Up BLOCKED	01 30 to 06 30. Track maintenance 25 $\frac{1}{2}$ m.p. and 26m. 12chs.
-----	--	------------------------	--

MONDAY 1 TO FRIDAY 5 DECEMBER

259	Stanford-le-Hope and Pitsea	Down BLOCKED	23 55 Mon to Thu to 05 00 Tue to Fri. Track maintenance. 29 and 29 $\frac{1}{2}$ m.p. Mechanical equipment in use. <u>Single line working over Up line.</u>
-----	--------------------------------	-----------------	---

SECTION C

SIGNALLING AND PERMANENT WAY ALTERATIONS

- * * Items marked thus will not appear in future issues and a note must be
- * taken of them by all concerned.

DETAILS OF WORK REFERRED TO IN SECTION B

SUNDAY 30 NOVEMBER - MILE END YARD

The 3 aspect colour light signal No.B113 which reads from Mile End Yard Up Reception to the Down Electric line will be replaced by an elevated position light signal (8ft above rail level), 19ft on the approach side of the outlet trap points.

(39)

SUNDAY 30 NOVEMBER - TROWSE AREA

New colour light signalling will be commissioned as shown in Supplementary Signalling Notice No. 146.

All concerned should be in possession of a copy of this notice.

(39)

MONDAY 1 DECEMBER - BETWEEN PARKESTON GOODS JN AND WRABNESS

W.e.f. 10 00 hours, the ³⁰ m.p.h. Temporary Speed Restriction on the UP line
50
between 66m. 70chs. and 66m. 10chs. will become a PERMANENT SPEED
RESTRICTION.

(See Section 'D') (39)

DETAILS OF WORK ALREADY CARRIED OUT

NEW HALL

The Up Loop has been taken out of use Until Further Notice.

(UFN)

HATFIELD PEVEREL

The facing and trailing crossovers are out of use until further notice.

(UFN)

SECTION C - SIGNALLING AND PERMANENT WAY ALTERATIONS - continued

DETAILS OF WORK ALREADY CARRIED OUT - continued

SWAINSTHORPE AUTOMATIC HALF-BARRIERS AT 109M. 54CHS.

When the road works are resumed, the crossing will be closed to road traffic and the barriers secured in the lowered position until such time as the work is completed.

(UFN)

TROWSE LOWER JUNCTION

The trailing connection Up Siding/Up Main nearest to the signalbox and on the Norwich side has been secured out of use pending removal.

The associated yellow faced disc shunting signal has been abolished.

(38)

* * BETWEEN HETHERSETT AND TROWSE LOWER JUNCTION

*

Hethersett

The Down Main semaphore Starting Signal has been replaced by a 2-aspect (RED/GREEN) colour light signal plated HT13, 35 yards further from the signal box.

The Up Main Home 2-aspect colour light signal No. HTB has been repositioned 1,350 yards further from the signal box on a new right-hand bracket post.

The Up Main colour light Distant signal No. HTA (together with its associated A.W.S. track inductor) has been repositioned 1 $\frac{1}{2}$ miles further from the signal box to a position 2,037 yards before reaching the repositioned Up Home signal.

Reference should be made to the associated diagram included in this notice.

Level Crossings

Intwood Automatic Half-barrier Level Crossing at 119m. 47chs.

Keswick Automatic Half Barrier Level Crossing at 120m.p.

The barriers at these crossings are equipped to work automatically when approached in the reverse direction and for this purpose, combined St. Andrew's Cross/30m.p.h. speed restriction signs have been provided applicable to each rail approach to the crossings in the wrong direction.

SECTION C - SIGNALLING AND PERMANENT WAY ALTERATIONS - continuedDETAILS OF WORK ALREADY CARRIED OUT - continued** BETWEEN HETHERSETT AND TROWSE LOWER JUNCTION - continued

*

Eaton Minature Warning Lights Level Crossing at 120m. 29chs.

A combined St. Andrew's Cross/30m.p.h. speed restriction sign has been provided applicable to each wrong direction rail approach to Eaton Level Crossing.

A 'Whistle' board has been provided on each rail approach for normal and wrong direction of travel.

The distance of the St. Andrew's Cross/speed restriction signs and 'Whistle' boards from the three level crossings is as shown on the diagram.

(36)

** AUDLEY END

*

3-aspect signal CA47, reading from the Up Main to Down Main at the north end of Audley End Up Platform, has been fitted with AWS equipment, 100 yards on the approach side of the signal.

(36)

** BETWEEN GAS FACTORY JN AND EAST HAM

*

The 60 m.p.h. Permanent Speed Restriction on the Down line between 2m. 73chs. and 6 $\frac{1}{2}$ m.p. has been withdrawn and the following Permanent Speed Restrictions now apply on the Down line:-

60 m.p.h. between 2m. 73chs. and 3m. 12chs.

70 m.p.h. between 3m. 12chs. and 6m.p.

60 m.p.h. between 6m.p. and 6 $\frac{1}{2}$ m.p.

(See Section 'D') (36)

SECTION C - SIGNALLING AND PERMANENT WAY ALTERATIONS - continued

DETAILS OF WORK ALREADY CARRIED OUT - continued

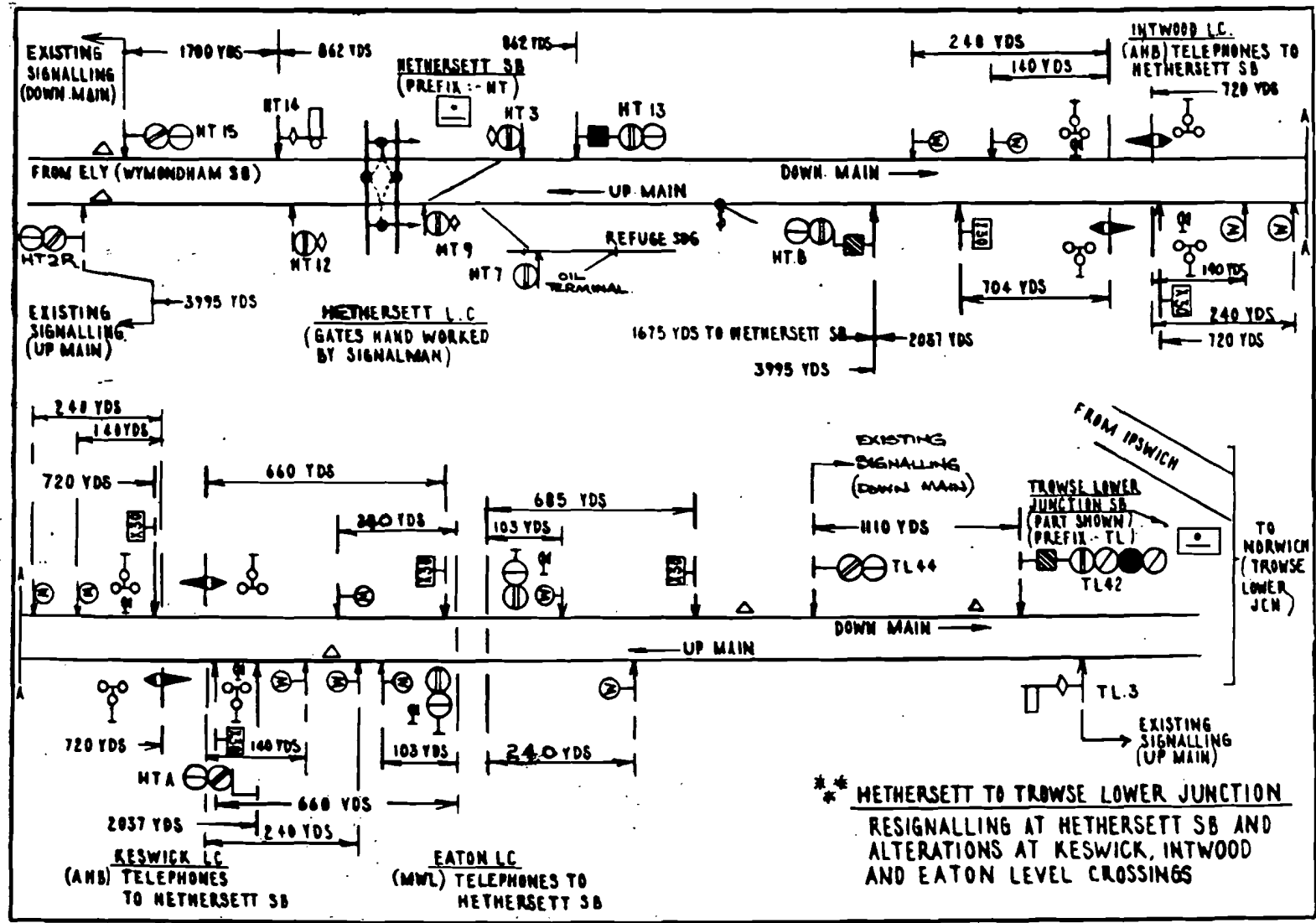

** HETHERSETT TO TROWSE LOWER JUNCTION
RESIGNALLING AT HETHERSETT SB AND
ALTERATIONS AT KESWICK, INTWOOD
AND EATON LEVEL CROSSINGS

SECTION DGENERAL INSTRUCTIONS AND NOTICES

A thick vertical line denotes new or amended items.

** Items marked thus will not appear in future issues and a note must be taken
* of them by all concerned.

WORKING MANUAL FOR RAIL STAFF
(B.R. 30054)

WHITE PAGES - PART 6Page C17

Warning - A -

Amend to read:- Wagon conveys dangerous goods ref. 2A - no more than one wagon or one 30' container permitted on Guardless train.

Page C18

Rejected - S -

Amend to read:- Wagon conveys dangerous goods not permitted on Guardless train.

Rejected - T -

Amend to read:- Warning - T - Wagon is of a type which may not be permitted on Guardless train.

Insert:- Warning - ? - Wagon has special handling code XLD refer to conditions of travel to check suitability for Guardless train.

Insert:- Rejected - . - Locomotive not equipped for Guardless train.

Amend:- Rejected - max. no. of D.I.T. locos. exceeded. See GA S2 Cl.1.5/1.7 to read:- GA S2 Pages 2.7-2.10.

Amend:- Rejected - D.I.T. Shunting loco. Must run Class 9. See GA S2 Cl. 1.5/1.7 to read:- GA S2 Pages 2.7-2.10.

Clause D5/2: Delete 2nd sentence.

Clause D5/3: Delete 1st sentence.

Insert "loaded and empty" between "both" and "conditions" in the existing 2nd sentence.

Clause D5/5: Amend "Clauses 12.10(b) and (c)" to read:- "Clauses 12.10.1(b) and (c)".

Clause D5/14: Amend speed of HAA (loaded) to 55.

Clause D9/6: Amend to read:-

It is essential that all handbrakes are fully released before a wagon is moved to prevent damage to the wheels.

SECTION D - GENERAL INSTRUCTIONS AND NOTICES - continued

WORKING MANUAL FOR RAIL STAFF - (B.R. 30054) - continued

WHITE PAGES - PART 6 - continued

Clause D9/6: - continued

Staff must ensure that they are fully aware of the correct method of hand-brake release as it does vary between individual wagon types as shown below:-

- (a) Clockwise to apply - anti-clockwise to release.
- (b) Anti-clockwise to apply - clockwise to release.
- (c) Separate hand-brakes on each bogie of a bogie wagon.
- (d) Both (a) and (b) can apply on a wagon depending on which side of the wagon the brakes are being released from (see D9/1).

After releasing the hand-brakes, wherever possible, staff must check by visual means that the brake has in fact been released by checking "indicators" where fitted, the brake rigging is slack and the hand-brake wheel will not turn any more.

The fact that the hand-brake wheel is slack is no positive indication that the brake has been released.

Clause D9/8: Delete.

(12.SD)

SECTION D - GENERAL INSTRUCTIONS AND NOTICES - continued

EASTERN REGION SECTIONAL APPENDIX (SOUTHERN AREA)

TABLE A : DETAILS OF RUNNING LINES

Running Lines and Signalling System	Location	M. Ch.	Permanent Speed Restrictions		Remarks
			Down m.p.h.	Up m.p.h.	
<p><u>LIVERPOOL STREET TO NORWICH</u></p> <p>Page 57 (Page 23, SD PON)</p> <p>At Colchester (CO)</p> <p><u>Amend</u> 'Remarks' column entry to read:-</p>					<p>Colchester (CO) signal box area between Colchester and Swainsthorpe.</p>

SE-56

SECTION D - GENERAL INSTRUCTIONS AND NOTICES - continued

EASTERN REGION SECTIONAL APPENDIX (SOUTHERN AREA) - continued

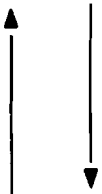
Running Lines and Signalling System	Location	M. Ch.	Permanent Speed Restrictions		Remarks
			Down m.p.h.	Up m.p.h.	
LIVERPOOL STREET TO NORWICH - continued					
Page 60 (Page 23, SD PON)					
At Haughley LC (AHB)					
Amend 'Remarks' column entry to read:-					
Pages 60 and 61 (Pages A29 and 24, SD PON)					
Delete all details between Mellis LC (AHB-X) and Trowse Lower Jn and substitute:-					
	Mellis LC (AHB-X)	91 34	X50	X50	<u>Approaching level crossing in wrong direction.</u> Telephone to Colchester signal box at 92m. 77chs. (Signal CO 424R).

SE-57

SECTION D - GENERAL INSTRUCTIONS AND NOTICES - continued

EASTERN REGION SECTIONAL APPENDIX (SOUTHERN AREA) - continued

Running Lines and Signalling System	Location	M. Ch.	Permanent Speed Restrictions		Remarks
			Down m.p.h.	Up m.p.h.	
LIVERPOOL STREET TO NORWICH - continued					
Pages 60 and 61 (Pages A29 and 24, SD FON) - continued:-					
<u>Delete</u> all details between Mellis LC (AHB-X) and Trowse Lower Jn and <u>substitute</u> - continued:-					
	Palgrave LC (AHB-X)	94 04	X50	X50	<u>Approaching level crossing in wrong direction.</u>
	Diss	94 79			
	Audley End (Norfolk) LC (AHB-X)	97 05	X50	X50	<u>Approaching level crossing in wrong direction.</u>
	Burston LC (AHB-X)	97 42	X50	X50	<u>Approaching level crossing in wrong direction.</u>

SECTION D - GENERAL INSTRUCTIONS AND NOTICES - continued

EASTERN REGION SECTIONAL APPENDIX (SOUTHERN AREA) - continued

Running Lines and Signalling System	Location	M. Ch.	Permanent Speed Restrictions		Remarks
			Down m.p.h.	Up m.p.h.	
<u>LIVERPOOL STREET TO NORWICH - continued</u>					
Pages 60 and 61 (Pages A29 and 24, SD PON) - continued:-					
<u>Delete</u> all details between Mellis LC (AHB-X) and Trowse Lower Jn and <u>substitute</u> - continued:-					
	Gissing LC (AHB-X)	98 57	X50	X50	<u>Approaching level crossing in wrong direction.</u>
	Hales Street LC (AHB-X)	100 27	X50	X50	<u>Approaching level crossing in wrong direction.</u>
	Tivetshall LC (AHB-X)	100 43	X50	X50	<u>Approaching level crossing in wrong direction.</u>
	Moulton LC (AHB-X)	101 51	X50	X50	<u>Approaching level crossing in wrong direction.</u>
	Flordon	106 63			
					Telephones to Colchester signal box at 104m. 41chs. (Signal CO 448R) and at 105m. 19chs. (Signal CO 453R).

SE-59

SECTION D - GENERAL INSTRUCTIONS AND NOTICES - continued

EASTERN REGION SECTIONAL APPENDIX (SOUTHERN AREA) - continued

Running Lines and Signalling System	Location	M. Ch.	Permanent Speed Restrictions		Remarks	
			Down m.p.h.	Up m.p.h.		
<u>LIVERPOOL STREET TO NORWICH - continued</u>						
Pages 60 and 61 (Pages A29 and 24, SD FON) - continued:-						
<u>Delete all details between Mellis LC (AHB-X) and Trowse Lower Jn and substitute - continued:-</u>						
	Newton Flotman LC (AHB-X)	108 19	<u>X50</u>	<u>X50</u>	<u>Approaching level crossing in wrong direction.</u>	
	Swainsthorpe LC (AHB-X)	109 54	<u>X50</u>	<u>X50</u>	<u>Approaching level crossing in wrong direction.</u>	
				<u>90</u>	<u>111m. 15chs. and 110m. 55chs.</u>	Telephones to Colchester signal box at 110m. 16chs. (Signal NO 541R) and at 111m. 07chs. (Signal CO 460R).
				<u>80</u>	<u>111m. 15chs. and 112m. 62chs.</u>	
				<u>40</u>	<u>112m. 62chs. and 113m. 46chs.</u>	
			<u>35</u>	<u>113m. 46chs. and 123m.p.</u>		
	Trowse Lower Jn (See page 103)	113 68 123 00			Norwich (NO) signal box area between Swainsthorpe (exclusive) and Trowse Lower Jn (exclusive). (12.SD)	

SE-60

SECTION D - GENERAL INSTRUCTIONS AND NOTICES - continued

EASTERN REGION SECTIONAL APPENDIX (SOUTHERN AREA) - continued

Running Lines and Signalling System	Location	M. Ch.	Permanent Speed Restrictions		Remarks
			Down m.p.h.	Up m.p.h. At or Between	
<p><u>MANNINGTREE SOUTH JN TO HARWICH</u></p> <p><u>Page 71</u> (page 29, SD PON)</p> <p>Between Wrabness Footpath LC (R/G) and Parkeston Goods Jn</p> <p><u>Add</u> :-</p>				<p><u>30</u> <u>50</u></p> <p><u>66m. 70chs. and 66m. 10chs.</u></p> <p><u>(w.e.f. 10 00 hours, Monday 1 December) (12.SD)</u></p>	
<p><u>BETHNAL GREEN JN TO KING'S LYNN</u></p> <p><u>Page 82</u> (Page 35, SD PON)</p> <p>At Reading Lane Jn</p> <p><u>Amend</u> :-</p>			<u>10</u>	<p><u>To Graham Road Curve line.</u></p>	(12.SD)

SE-61

SECTION D - GENERAL INSTRUCTIONS AND NOTICES - continued

EASTERN REGION SECTIONAL APPENDIX (SOUTHERN AREA) - continued

Running Lines and Signalling System	Location	M. Ch.	Permanent Speed Restrictions		Remarks	
			Down m.p.h.	Up m.p.h.		
<u>READING LANE JN TO NAVARINO ROAD JN (GRAHAM ROAD CURVE)</u>						
<p><u>Page 88</u> (Page 38, SD PON)</p> <p><u>Delete</u> all details and <u>substitute</u>:-</p>						
<p> </p>	<p>Reading Lane Jn (See page 82)</p>	2 55	<u>10</u>	<u>30</u>	<p>MAXIMUM PERMISSIBLE SPEED</p> <p><u>2m. 55chs. and 2m. 71chs.</u></p>	<p>Controlled by Hackney Downs (H) signal box.</p>
	<p>Navarino Road Jn (See page 63)</p>	2 79				<p>Controlled by Dalston Western Jn. (DW) signal box.</p> <p>(12.SD)</p>
<u>ELY NORTH JN TO PETERBOROUGH, CRESCENT JN</u>						
<p><u>Page 97</u></p> <p>At Norwood Road LC</p> <p><u>Amend</u> 'Remarks' columns entry to read :-</p>					<p>UGL.76.</p> <p>(12.SD)</p>	

SE-62

SECTION D - GENERAL INSTRUCTIONS AND NOTICES - continued

EASTERN REGION SECTIONAL APPENDIX (SOUTHERN AREA) - continued

Running Lines and Signalling System	Location	M. Ch.	Permanent Speed Restrictions		At or Between	Remarks
			Down m.p.h.	Up m.p.h.		
<p><u>ELY NORTH JN TO TROWSE LOWER JN</u></p> <p>Page 103</p> <p>Delete all details between Hethersett and Trowse Lower Jn and <u>substitute:-</u></p>						
	Hethersett (HT) LC	117 73				URS 48
	Intwood LC (AHB-X)	119 47	X30	X30	<u>Approaching level crossing in wrong direction.</u>	C. Up at 118m. 48chs. (457 yards after passing signal HT B).
	Keswick LC (AHB-X)	120 00	X30	X30	<u>Approaching level crossing in wrong direction.</u>	
	Eaton LC (R/G-X)	120 29	X30	X30	<u>Approaching level crossing in wrong direction.</u>	
	Trowse Lower Jn (See page 61)	123 00				

(12.SD)

SE-63

SECTION D - GENERAL INSTRUCTIONS AND NOTICES - continued

EASTERN REGION SECTIONAL APPENDIX (SOUTHERN AREA) - continued

Running Lines and Signalling System	Location	M. Ch.	Permanent Speed Restrictions		Remarks
			Down m.p.h.	Up m.p.h.	
<p><u>FENCHURCH STREET TO SHOEBOURNESS</u></p> <p><u>Pages 104 and 105</u></p> <p><u>Delete all details between Gas Factory Jn and East Ham and substitute:-</u></p>					
	Gas Factory Jn (See page 107)	2 57	<u>20</u>		<u>To Bow Jn line.</u>
	OHNS	3 75		<u>60</u>	<u>2m. 73chs. and 3m. 12chs.</u>
				<u>70</u>	<u>3m. 12chs. and 6m.p.</u>
			<u>60</u>	<u>6m.p. and 2m. 73chs.</u>	
	East Ham	6 40		<u>60</u>	<u>6m.p. and 6½m.p.</u>
				<u>40</u>	<u>6½m.p. and 7m. 08chs.</u>
			<u>55</u>	<u>6m. 50chs. and 6m.p.</u>	
					(12.SD)

SE-64

SECTION D - GENERAL INSTRUCTIONS AND NOTICES - continued

EASTERN REGION SECTIONAL APPENDIX (SOUTHERN AREA) - continued

Running Lines and Signalling System	Location	M. Ch.	Permanent Speed Restrictions		Remarks
			Down m.p.h.	Up m.p.h.	
<u>FENCHURCH STREET TO SHOEURYNNESS - continued</u>					
<u>Page 105</u>					
<u>Delete:-</u>	Dagenham East GF's	11 25			(12.SD)
<u>TILBURY RIVERSIDE TO PITSEA</u>					
<u>Amend:-</u>	Fobbing LC (AHB)	30 34			(12.SD)

SE-65

SECTION D - GENERAL INSTRUCTIONS AND NOTICES - continuedEASTERN REGION SECTIONAL APPENDIX (SOUTHERN AREA) - continuedINSTRUCTIONS RELATING TO THE RULE BOOKPage 264 (Pages 49 and 50, SD PON)POWER OPERATED POINTS - WRONG DIRECTION MOVEMENTS

<u>Signalbox/location</u>	<u>Point Nos.</u>	
<u>Amend</u> East Gate Jn entry to read :-		
East Gate Jn	25,29	(12.SD)

OTHER GENERAL INSTRUCTIONSPages 278 and 279 (Pages 56 and 57, SD PON)FIXED AUDIBLE TRACK CIRCUIT OPERATED WARNING SYSTEMS

<u>Location</u>	<u>Description</u>
<u>Add:-</u>	
<u>Fenchurch Street to Shoeburyness</u>	
Christian Street Jn.	Covers Down and Up Main lines between Om. 62chs. and Om. 72chs.
Stepney	Two independent systems covering Down and Up lines between:- (i) 1m. 10chs. and 1m. 26chs. (ii) 1m. 26chs. and 1m. 44chs.
	(12.SD)

SECTION D - GENERAL INSTRUCTIONS AND NOTICES - continuedEASTERN REGION SECTIONAL APPENDIX (SOUTHERN AREA) - continuedOTHER GENERAL INSTRUCTIONS - continued

Page 297 (Page A37, SD PON)

DOCKLANDS LIGHT RAILWAY LINE BETWEEN BOW JN AND STRATFORD STATION
(ADJACENT TO THE B.R. UP ELECTRIC LINE)Delete heading and instructions and substitute:-DOCKLANDS LIGHT RAILWAY LINES ADJACENT TO B.R. LINES
BETWEEN BOW JN AND STRATFORD AND BETWEEN CHRISTIAN STREET JN AND STEPNEY EAST

B.R. staff must observe the provisions of the previous instructions on pages 294 to 297 headed, "Instructions to Train Crews Working other than D.C. Electric trains and other staff concerned working over or in the vicinity of D.C. Electrified lines", except that reference to Electrical Control Operator should be read as Controller and Supervisor at Poplar Control Centre, who can be contacted via the Signaller at Bow Jn, Stratford or Fenchurch Street or the Electrical Control Operator at Romford or on British Telecom 538 3440.

The Docklands Light Railway when fully operational will work automatically without lineside signals, using Driverless trains which will approach in either direction travelling at a maximum speed of 50 m.p.h. Each train will convey a member of the Docklands Light Railway staff called a "Train Captain".

Docklands trains will not sound a warning to persons on or near the line etc., and B.R. staff must not, therefore, except in emergency go on to the Docklands Light Railway.

Between Bow Jn and Stratford posts are provided in the 10 foot between the Up Electric line and the Docklands line to identify the point beyond which staff must not proceed. When staff stand clear of the Up Electric line they must align themselves between the posts.

Between Christian Street Jn and Stepney East the only position of safety in accordance with Rule Book, Section B, Clause 5.3.4 is on the North (Down) side of the viaduct and on the approach of a B.R. train staff must immediately proceed to the North side.

Between Christian Street Jn and Stepney East and in the vicinity of Bow Jn signal box and overbridge 609 (Fairfield Road), staff must not, except in emergency, proceed beyond the fence between B.R. and Docklands line. If unavoidable circumstances compel staff to remain between the B.R. and Docklands lines when trains pass, they must lay down against the B.R. side of the fence. It is important that this instruction is observed as the collector shoes of Docklands Light Railway trains will pass in close proximity to the Docklands side of the fence.

SECTION D - GENERAL INSTRUCTIONS AND NOTICES - continuedEASTERN REGION SECTIONAL APPENDIX (SOUTHERN AREA) - continuedOTHER GENERAL INSTRUCTIONS - continuedPage 297 (Page A37, SD PON) - continuedDOCKLANDS LIGHT RAILWAY LINES ADJACENT TO B.R. LINES BETWEEN BOW JN AND STRATFORD AND BETWEEN CHRISTIAN STREET JN AND STEPNEY EAST - continued

If an emergency mishap occurs on B.R. lines requiring the stopping of trains on the Docklands Light Railway, standard B.R. protection arrangements must be observed and advice given to the Poplar Control Centre by the quickest available means. It should be noted that the placing of a Track Circuit Operating Clip on the Docklands line will stop a train which is in automatic mode.

(12.SD)

LOCAL INSTRUCTIONSPage 317WICKFORD TO SOUTHMINSTERAdd :-WOODHAM FERRERS A.O.C.L. LEVEL CROSSING

Woodham Ferrers level crossing must be worked in accordance with the General Appendix Instructions for A.O.C.L. level crossings, except that in the event of the red road signals not being automatically initiated, the Driver must press the plunger located in a locked Cabinet (Drivers No. 1 Key) on the White light post to activate the road signals. When the white light is flashing, the Driver may proceed as normal. If, after operation of the plunger, the white light still does not flash, the Driver must proceed in accordance with Clause 3.3 of the instructions.

(12.SD)

Page 327BETHNAL GREEN TO KING'S LYNNAdd:-DOWNHAM MARKET

Drivers of Up stopping passenger trains must stop in rear of the Up section signal, even though the signal may be displaying a green aspect and not proceed forward until the station duties have been completed.

(12.SD)

SECTION D - GENERAL INSTRUCTIONS AND NOTICES - continued

EASTERN REGION SECTIONAL APPENDIX (SOUTHERN AREA) - continued

LOCAL INSTRUCTIONS - continued

Page 333

FENCHURCH STREET TO SHOEBURYNESS

Add:- BETWEEN CHRISTIAN STREET JN AND STEPNEY EAST

Rule Book, Section B, Clause 5.3.8 and General Appendix Instruction -
Safety of Staff called by Signalman to work on the line

Staff must not commence work on the Up side of a train on the Up line unless they have received an assurance from the Signalman that trains on the Down Docklands line have been stopped.

If staff called by the Signalman to work on the line consider that they cannot work safely with trains running on the Down Docklands line, they must not commence work until an assurance has been received from the Signalman that Down Docklands trains have been stopped.

(12.SD)

MISCELLANEOUS NOTICES

ENGINEERING WORK BETWEEN BETHNAL GREEN AND BOW JN
DIVERSION OF NEWSPAPER TRAINS VIA TOTTENHAM HALE
SUNDAY 30 NOVEMBER

The following diverted newspaper trains are authorised to run between Liverpool Street and Tottenham Hale, where the trains will reverse, with a locomotive attached in rear:-

1Y02 02 20 Liverpool Street to Stowmarket
1W46 03 15 Liverpool Street to Shenfield
1K06 03 45 Liverpool Street to Southend Victoria

The following conditions must be observed:-

1. The provisions of the Rule Book, Section H, Clause 3.20 and the preamble to Sectional Appendix, Table J must be observed.
2. Except in emergency, the Driver of the rear locomotive must not apply power.
3. If the rear locomotive is S.S.S. fitted, the reverser must be placed in the direction of travel.

(36)

SECTION D - GENERAL INSTRUCTIONS AND NOTICES - continued

MISCELLANEOUS NOTICES - continued

FENCHURCH STREET TO SHOEBURYNESSE LINE DUNTON AREA
INSTALLATION OF NEUTRAL SECTION

Between 01 15 and 18 00 hours Sunday 30th November, a NEUTRAL SECTION will be installed at overhead line structure A20/34A on the Down Main between West Horndon and Laindon Stations (20m. 76chs.).

(12.SD)

INSTRUCTIONS FOR D.C. ELECTRIFIED LINES
BETWEEN EUSTON-WATFORD JN, CROXLEY GREEN-NORTH WOOLWICH B.R.29636

Supplement No. 2 to the above publication is in the course of being distributed.

Any member of staff who is in possession of the current issue of B.R.29636 who has not received a copy of the Supplement must promptly advise his Supervisor.

(37)

PERMANENTLY COUPLED D.B. 2 x 45 TONNE VANS

The West German Railways are manufacturing 200 45 tonne 2 axle general merchandise vans which will be permanently coupled in 100 pairs.

Each pair of wagons will be identified by a single number in the following range:-

23 80 2794 000-2 to 23 80 2794 099-4

Only one wagon in each pair is fitted with a distributor, and in the event of a coupling breaking the brakes would only apply on the wagon fitted with the distributor - the air supply to the "slave wagon" would be lost when the pipes parted.

For this reason:-

1. These wagons must not be included in a fully fitted block train of this type of wagon.
2. These wagons must not be included in the rear-most three positions of any other fully fitted freight train.
3. Any train including a pair of these wagons, must consist of a minimum of 5 vehicles, to avoid these D.B. wagons being in the last three.

The TOPS trainlist programme will be altered as soon as possible to reflect this.

(12.D)

SECTION D - GENERAL INSTRUCTIONS AND NOTICES - continuedMISCELLANEOUS NOTICES - continued* * WORKING INSTRUCTIONS FOR A.C. ELECTRIFIED LINES - BR.29987

*

From 1st December 1986, a new book will take effect which will replace the current edition dated 3rd May 1975 and the amendments thereto.

The book will be in loose leaf form, A5 size, with a flexible cover and its format has been designed so that part of the book can be separately issued in place of the existing "Extracts from the Working Instructions" book BR.29988, which will be discontinued from the same date.

The new book is divided into three main sections viz:-

Section A (BR.29987) - Definitions, Description of System and General Instructions. This will be issued to every employee working on or in the vicinity of lines electrified on the A.C. overhead line system.

Section B (BR.29987/14) - Isolation and Earthing of Overhead Line Equipment.

Section C (BR.29987/15) - Protection of Staff Servicing/Maintaining Locomotives or Trains in Sidings/Depots equipped for electric traction.

Note: Sections B and C will be issued only to staff involved with the instructions contained therein.

The new book is currently being distributed and the appropriate section(s), together with a copy of the explanatory leaflet, BR.29987/16, must be made available to staff immediately upon receipt.

Any member of the staff who is in possession of the current issue of the A.C. Working Instructions, or Extracts thereto, who has not received a copy of the appropriate section(s) of the new book must promptly advise his Supervisor.

(36)

GREAT EASTERN ELECTRIFIED LINES : BARKING AREAINSTALLATION OF DEAD SECTION

A DEAD SECTION has been installed at overhead line structure number A7/12 at 7m. 12chs. on the UP MAIN, London side of Barking Flyover.

(12.SD)

SECTION D - GENERAL INSTRUCTIONS AND NOTICES - continued

MISCELLANEOUS NOTICES - continued

WORKING OF CLASS 313 AND CLASS 416 ELECTRIC MULTIPLE UNIT
TRAINS BETWEEN DALSTON WESTERN JN AND STRATFORD MARKET

Class 313 Electric Multiple Units

These units must only work between Navarino Road Jn and Stratford Market stabling sidings when either the Graham Road Curve route to Liverpool Street is not available, or when the pantographs have failed to rise. When operating between Dalston Kingsland and Stratford Market stabling sidings and return in the D.C. mode, Drivers must not advance the controller beyond Notch 2.

THESE UNITS MUST NOT RUN BEYOND STRATFORD MARKET TOWARDS NORTH WOOLWICH.

Class 416 Electric Multiple Units

Not more than two Class 416 units may be coupled together.

When two Class 416 units are running in multiple between Dalston Western Jn and Stratford Market, including the stabling sidings or return, Drivers must not advance the controller beyond Notch 2.

(UFN)

BETWEEN STEPNEY EAST AND FENCHURCH STREET

Until further notice, staff of the Docklands Light Railway will be laying in track adjacent to the Up Main/Slow line between Stepney East Station (lm. 58chs.) and Fenchurch Street. Restricted clearances exist and Drivers must keep a sharp look out and be prepared to sound the warning horn as necessary.

(UFN)

BETHNAL GREEN STATION

Until Further Notice, whilst demolition work is taking place, Drivers of 4-Car EMU trains must stop their trains at the temporary stop boards provided.

(UFN)

CAMBRIDGE HEATH STATION

Whilst platform repairs are taking place, Drivers of trains must stop their trains at the temporary stop boards provided.

(UFN)

LONDON FIELDS STATION

The station has reopened but platform repairs are taking place. Whilst this work is being carried out, Drivers must stop their trains at the temporary stop boards provided.

(UFN)

SECTION D - GENERAL INSTRUCTIONS AND NOTICES - continuedMISCELLANEOUS NOTICES - continuedSAWBRIDGEWORTH STATION

The stop board on the Up platform has been temporarily moved 9 yards towards the Country side of its former position.

(UFN)

WANSTEAD PARK STATION

Whilst platform repairs are taking place, Drivers of Up trains must stop their trains at the temporary stop boards provided.

(UFN)

REPAIRS IN MOTIVE POWER DEPOTS, CARRIAGE SHEDS, WAGON REPAIR SHEDS AND WAREHOUSES

In connection with work being carried out at the undermentioned places, scaffolding or projections may be provided or unusual excavations may be made in the ground:-

Location	Nature of Work	Duration	Commencing date
Stratford T.M.D. All lines.	Repairs to Motive Power Depot. Cranes and mechanical equipment in use.	Continuously. Until Further Notice.	-
Ilford EMU Depot, Nos. 19 and 20 Roads.	Drainage.	08 00 to 17 00 daily. Until Further Notice.	-
Ilford EMU Depot, 'B' Shop Roads Nos. 3, 4 and 5.	Construction work. <u>Isolation of electrical sections C3, 4 and 5.</u>	Continuously. Until further notice.	-
Ilford EMU Depot, Nos. 6, 7, 8, 9 and 10 Sidings (Country End) BLOCKED	Track renewal.	Continuously. Until further notice.	-
Norwich Crown Point T & R.S. M.D., All lines BLOCKED	Construction work (overhead line) and track maintenance. Mechanical equipment in use. <u>Possession to be given up for passage of trains.</u>	08 00 to 17 00 daily. Until further notice.	-

SECTION D - GENERAL INSTRUCTIONS AND NOTICES - continuedMISCELLANEOUS NOTICES - continuedREPAIRS IN MOTIVE POWER DEPOTS, CARRIAGE SHEDS, WAGON REPAIR SHEDS AND WAREHOUSES - continued

In connection with work being carried out at the undermentioned places, scaffolding or projections may be provided or unusual excavations may be made in the ground:-

Location	Nature of Work	Duration	Commencing date,
East Ham EMU Depot, All lines.	Shed reconstruction.	Continuously. Until Further Notice.	-
East Ham EMU Depot, Washer Road BLOCKED	Repairs to washer plant. <u>Isolation of</u> <u>electrical sections</u> <u>509A.</u>	Continuously. Until Further Notice.	-
East Ham EMU Depot, Nos. 10 and 11 Maintenance Shed Roads BLOCKED	Construction work. <u>Isolation of electrical</u> <u>sections EH10, EH11.</u>	Continuously. Until Further Notice.	-

MP.32/SE
YORK
20 NOVEMBER, 1986

C. McKEEVER
Regional Operations Manager

BRITISH RAIL
EASTERN REGION

SE

37

WEEKLY OPERATING NOTICE

CONTAINING

TEMPORARY SPEED RESTRICTIONS

TEMPORARY ENGINEERING WORKS

SIGNALLING AND
PERMANENT WAY ALTERATIONS

GENERAL INSTRUCTIONS AND NOTICES

SATURDAY 6 DECEMBER

TO

FRIDAY 12 DECEMBER 1986

INCLUSIVE

Trainmen must pay particular attention to works contained in this notice and keep a good look-out for handsignals which may be exhibited in accordance with the Rules and Regulations.

Work at places other than those mentioned may be in progress and Drivers must be on the look-out and be prepared to stop or run at reduced speed when, and where, handsignals may be exhibited.



WARNING



A.C. ELECTRIFIED LINES - ANGLIA WEST

EXTENSION OF ELECTRIFICATION FROM BISHOPS STORTFORD TO CAMBRIDGE

The Overhead Line Equipment has been extended Northwards from Bishops Stortford through Stansted, Elsenham, Newport, Audley End, Great Chesterford, Whittlesford, Shelford and Shepreth Branch Junction to a point approximately 1/4 of a mile north of Cambridge Station.

From 00 01 hours, Monday 8th December 1986, the Overhead Line Equipment will be energised at 25,000 Volts and must thereafter be regarded as being 'ALIVE' at all times.

The limits of energisation will be:-

At 336 yards north of the 56 1/2 mile post north of Cambridge Station.

- Structure Nos:- C90/46 DOWN GOODS LOOP NORTH
- C90/50 DOWN MAIN
- C90/47 UP MAIN
- C90/52 CARRIAGE DEPOT ROAD NO. 5

At 82 yards East of the 55 mile post on Royston side of Shepreth Branch Junction.

- Structure Nos:- EC88/21 DOWN ROYSTON
- EC88/22 UP ROYSTON

The Working Instructions for A.C. Electrified Lines (B.R. 29987) will apply.



WARNING



* * A.C. ELECTRIFIED LINES - ANGLIA EAST *

EXTENSION OF ELECTRIFICATION FROM HAUGHLEY JUNCTION TO TIVETSHALL

The Overhead Line Equipment has been extended from Haughley Junction, through Diss to Tivetshall.

The Overhead Line Equipment has been energised at 25,000 Volts and must be regarded as being 'ALIVE' at all times.

The limits of energisation are:-

At 100 mile post south of Tivetshall.

Structure Nos. B161/03 DOWN MAIN
B161/04 UP MAIN

The Working Instructions for A.C. Electrified Lines (B.R. 29987) will apply.

SECTION A

TEMPORARY SPEED RESTRICTIONS

(Until further notice unless otherwise specified)

Warning Boards and Indicators provided unless otherwise shown.

† Indicates that the Warning Boards and Indicators will be moved as the work progresses. Where two speeds are shown for a restriction e.g. $\frac{20}{40}$ the Rule Book, Section U, Clause 1.2 applies.

* * * * *

RULE BOOK : SECTION U

* * * * *

* An experimental speed indicator board with black figures on a yellow *
 * background will be used in the Warning Board and Speed Indicator *
 * board for the following Temporary Speed Restriction:- *
 * * * * *

* Church Lane LC	Down	Up	29 24	29 57	20	Trackwork.
* and Chelmsford						

* In addition to the above equipment an experimental black and white *
 * zebra striped board with twin high powered flashing white lights *
 * will be located at the A.W.S. temporary magnet for the Temporary *
 * Speed Restriction shown above. This board with lights does not *
 * affect the conditions for Drivers working over the Temporary Speed *
 * Restriction, being located only for the purpose of obtaining *
 * reactions to their effectiveness for sighting. *
 * * * * *

* Drivers and Traction Inspectors encountering the experimental *
 * indicators are requested to submit their comments to the Regional *
 * Operations Manager, York under reference M045/1274 via their *
 * Local Supervisor. *
 * * * * *

Location	Lines affected	Mileage		Restr-		Remarks
		at or between	iction	M. Ch.	m.p.h.	
<u>LIVERPOOL STREET TO NORWICH</u>						
1 Bethnal Green Station Jn and Bow Jn	Down Main	Up Main	1 60	2 10	20	Trackwork. (86/33)
2 Bow Jn	Down Main	-	2 60	2 69	20	Bridgework (No. 46). (86/34)
3 Bow Jn	Down Electric	-	2 60	2 69	20	Bridgework (No. 46). (86/31)

SECTION A - TEMPORARY SPEED RESTRICTIONS - continued

Location	Lines affected		Mileage		Restr- iction m.p.h.	Remarks
			at M.	between Ch. M. Ch.		
<u>LIVERPOOL STREET TO NORWICH - continued</u>						
4 Bow Jn	-	Up Main	2 69	2 60	20	Bridgework (No. 46). <u>Warning board also provided on Up Cambridge line at 3m. 12chs. (86/34)</u>
5 Bow Jn	-	Up Electric	2 69	2 60	20	Bridgework (No. 46). <u>Warning boards also provided on Up Main line at 3m. 27chs. and on Up Cambridge line at 3m. 12chs. (86/34)</u>
6 Harold Wood and Brentwood	Down Main	Up Main	17 71	18 11	40	Condition of track. <u>From 14 00 Friday 12 December. (86/37)</u>
7 Brentwood and Ingatestone	Down Main	-	19 65	20 33	50	Condition of track. (86/14)
8 Church Lane LC and Chelmsford	Down	Up	29 24	29 57	20	Trackwork. (86/26) <u>Until 14 00 Monday 8 December.</u>
9 Chelmsford and New Hall G.F.	Down	-	30 50	30 65	50	Condition of track. (86/12)
10 Hatfield Peverel and New Hall G.F.	-	Up	34 60 †	34 20	40	Trackwork. (86/35)

SECTION A - TEMPORARY SPEED RESTRICTIONS - continued

Location	Lines affected		Mileage		Restr- iction	Remarks
			M. Ch.	M. Ch.		
<u>LIVERPOOL STREET TO NORWICH - continued</u>						
11 Hatfield Peveler and Witham	Down	-	35 75	36 01	30	Trackwork. From <u>23 50</u> <u>Saturday 6</u> <u>December.</u> (86/37)
12 Witham and New Hall G.F.	-	Up	36 20	35 65	20	Earthwork. Until <u>11 00</u> <u>Friday 12</u> <u>December.</u> (86/28)
13 Kelvedon	-	Up	42 25	42 10	<u>50</u> 80	Condition of track. (86/7)
14 Ardleigh LC and Colchester Jn	-	Up	54 20	54 00	40	Trackwork. From <u>09 00</u> <u>Monday 8</u> <u>December.</u> (86/37)
15 Rectory Road LC and Palgrave LC	Down	-	91 23	91 38	60	Condition of From <u>00 01</u> <u>Saturday 6</u> <u>December.</u> (86/37)
16 Swainsthorpe LC and Trowse Lower Jn	Down	-	109 70	109 79	30	Earthwork. (86/36)
17 Trowse Lower Jn and Swainsthorpe LC	-	Up	112 60	112 40	30	Trackwork. (86/35) Until <u>10 00</u> <u>Friday 12</u> <u>December.</u>

SHENFIELD JN TO SOUTHEND VICTORIA

18 Billericay and Wickford Station	Down	-	26 10	26 44	40	Condition of track. (86/14)
19 Wick Lane LC and Rayleigh	Down	-	31 35	31 75	40	Condition of embankment. (84/41)

SECTION A - TEMPORARY SPEED RESTRICTIONS - continued

Location	Lines affected		Mileage at or between		Restr- iction m.p.h.	Remarks
			M.	Ch.		
<u>WICKFORD JN TO SOUTHMINSTER</u>						
20 Althorne LC and Burnham-on- Crouch	Single		41 10 †	42 10	20	Trackwork. (85/45)
<u>WITHAM TO BRAINTREE</u>						
21 Cressing and Braintree	Single		18 75	18 68	20	Bridgework (No. 2102B). (86/29)
<u>COLCHESTER TO CLACTON</u>						
22 Colchester Road - LC and Wivenhoe		Up	57 72 †	57 12	40	Condition of track. (86/26)
<u>EAST SUFFOLK JN TO OULTON BROAD NORTH JN</u>						
23 Bealings LC and Westerfield Jn		Up	74 60 †	73 44	30	Condition of track. (86/33)
<u>WESTERFIELD JN TO FELIXSTOWE</u>						
24 Trimley	Single		82 55	82 69	30	Trackwork. (86/33)
<u>NORWICH TO LOWESTOFT</u>						
25 Thorpe Jn and Whitlingham Jn	Down	Up	0 36	0 44	20	Trackwork. (85/20)
<u>BETHNAL GREEN JN TO KING'S LYNN</u>						
26 Enfield Lock		Up	11 71	11 60	50	Condition of track. (86/31)
27 Sawbridgeworth and Harlow Mill		Up	24 76	24 70	60	Condition of track. (86/16)

SECTION A - TEMPORARY SPEED RESTRICTIONS - continued

Location	Lines affected		Mileage		Restr- iction m.p.h.	Remarks
			at or between M. Ch. M. Ch.			
<u>BETHNAL GREEN JN TO KING'S LYNN - continued</u>						
28 Audley End Station and Audley End Tunnel	Down	-	42 17	42 38	40	Earthwork. From 23 45 Saturday 6 December. (86/37)
29 Whittlesford Station	-	Up	49 10	49 00	40	Platform work. (86/35)
<u>HACKNEY DOWNS NORTH JN TO ENFIELD TOWN</u>						
30 Stamford Hill	-	Up	5 12	4 78	20	Condition of track. (86/34)
31 Silver Street and Bury Street Jn	Down	Up	8 40	8 67	20	Trackwork. (86/34)
<u>ELY NORTH JN TO PETERBOROUGH, CRESCENT JN</u>						
32 Third Drove LC and Welney Road LC	Down	Up	78 00	78 18	20	Condition of track. (86/21)
33 Third Drove LC and Welney Road LC	Down	Up	78 42	78 60	20	Condition of track. (86/21)
34 March East Jn and Badgeney Road LC	-	Up Main	85 36	85 32	10	Condition of track. <u>Warning board positioned at signal ME.45.</u> <u>Additional warning board provided on the March East Jn to Wisbech line, positioned at signal ME.52.</u> (86/31)

SECTION A - TEMPORARY SPEED RESTRICTIONS - continued

Location	Lines affected			Mileage at or between		Restr- iction m.p.h.	Remarks
				M. Ch.	M. Ch.		
<u>ELY NORTH JN TO PETERBOROUGH, CRESCENT JN - continued</u>							
35 Three Horse Shoes No. 3 LC	Down	Up	90 74	90 78	20 50	Condition of track. (86/24)	

ELY NORTH JN TO TROWSE JN

36 Spooner Row	Down	-	111 23	111 33	40	Trackwork. From 22 45 <u>Saturday 6</u> <u>until 10 00</u> <u>Friday 12</u> <u>December.</u>
37 Hethersett and Trowse Lower Jn	Down	-	118 60	120 30	60	Signalling work. (86/33)
38 Trowse Lower Jn and Hethersett	-	Up	121 15	119 47	60	Signalling work. (86/33)
39 Eaton LC and Trowse Lower Jn	Down	Up	121 60	121 64	20	Bridgework (Nos. 1640 and 1640A). (86/23)

FENCHURCH STREET TO SHOE BURYNNESS

40 Gas Factory Jn and East Ham	Down	Up	4 02 †	4 22	20	Trackwork. (86/35)
-----------------------------------	------	----	--------	------	----	-----------------------

UPPER HOLLOWAY TO BARKING, TILBURY LINE JN WEST

41 South Tottenham East Jn and Black Horse Road	Down	-	6 45	6 57	20	Condition of track. (85/18)
42 Walthamstow Queens Road and Leyton Midland Road	Down	Up	8 34	8 39	20	Trackwork. (86/35)

SECTION A - TEMPORARY SPEED RESTRICTIONS - continued

<u>Location</u>	<u>Lines affected</u>	<u>Mileage</u> <u>at or between</u>				<u>Restr-</u> <u>iction</u> <u>m.p.h.</u>	<u>Remarks</u>
		<u>M.</u>	<u>Ch.</u>	<u>M.</u>	<u>Ch.</u>		
<u>TILBURY RIVERSIDE TO PITSEA</u>							
43 Stanford-le- Hope and Gardners LC	Down -	30	11	30	60	20	Trackwork. (86/34)
44 Gardners LC and Stanford-le- Hope	- Up	30	60	30	11	30	Trackwork. (86/34)

SECTION B

TEMPORARY ENGINEERING WORKS

At or between	Lines affected	Remarks
<u>LIVERPOOL STREET TO NORWICH</u>		
UNTIL FURTHER NOTICE		
45	Liverpool Street Station	Platform 1 Demolition work. Mechanical equipment in use. (86/30)
46	Liverpool Street Station	Platforms 1 to 10 Inc. Repairs to station roof. Mechanical equipment in use. (84/41)
47	Liverpool Street Station	Platforms 1 to 18 inc. Cleaning track. (85/21)
48	Liverpool Street Station	Platforms 8, 10 and 11 to 18 inc. Platform work and construction work. Mechanical equipment in use. (86/21)
49	Bethnal Green Station	Down Main and Down and Up Suburban. 08 00 to 16 00. Demolition work. (See Section 'D'). (85/41)
50	Bethnal Green and Bow Jn	All Signalling work. (86/25)
51	Stratford and Bow Jn	Up Electric 07 30 to 18 00. Construction work. Mechanical equipment in use. (85/62)
52	Forest Gate Jn and Ilford	All 07 00 to 18 00. Bridgework (No. 75A). 7m. 08chs. Mechanical equipment in use. (85/20)
53	Ilford Station	All 08 00 to 17 00. Repairs to station roof and painting station. (86/2)
54	Romford Jn and Gidea Park	All Bridgework (No. 102B). 12m. 48chs. Crane and mechanical equipment in use. (85/54)
55	Ingatestone and Chelmsford	Down and Up 07 30 to 18 00. Construction of bridge (No. 143A). 26m. 51chs. Mechanical equipment in use. (84/35)

SECTION B - TEMPORARY ENGINEERING WORKS - continued

At or between	Lines affected	Remarks
<u>LIVERPOOL STREET TO NORWICH - continued</u>		
UNTIL FURTHER NOTICE - continued		
56 Mellis LC and Trowse Lower Jn	All <u>Between Trains</u>	07 30 to 18 00. Signalling work. Points and signals disconnected. (86/15)
57 Diss	Down and Up	07 00 to 19 00. Earthwork. Crane and mechanical equipment in use. (85/27)
58 Diss and Audley End LC	Down and Up	Bridgework (No. 315). 95m. 29chs. (86/16)
59 Gissing LC	Down and Up	08 00 to 16 00. Level crossing road repairs. 98m. 56chs. Mechanical equipment in use. (86/26)
60 Hales Street LC	Down and Up	08 00 to 16 00. Level crossing road repairs. 100m. 26chs. Mechanical equipment in use. (86/28)
61 Tivetshall LC	Down and Up	07 30 to 18 00. Demolition work and level crossing road repairs. (Tivetshall LC). 100 ³ / ₄ m.p. Mechanical equipment in use. (86/28)
62 Newton Flotman LC	Down and Up	08 00 to 16 00. Level crossing road repairs. 108m. 17chs. Mechanical equipment in use. (86/26)
63 Swainsthorpe LC	Down and Up <u>Between Trains</u>	07 30 to 18 00. Level crossing road repairs and demolition work. 109m. 52chs. and 109 ³ / ₄ m.p. Mechanical equipment in use. (86/30)
64 Swainsthorpe LC and Trowse Lower Jn.	Down and Up	07 00 to 16 00. Bridgework (No. 346). 110m. 62chs. Mechanical equipment in use. (86/25)
65 Trowse Lower Jn and Norwich Station	All <u>Between Trains</u>	07 00 to 17 00. Construction work (overhead line), earthwork, track maintenance and signalling work. Points and signals disconnected. (86/7)
66 Trowse Swing Bridge	Down and Up <u>Between Trains</u>	Bridgework (No. 356). 123m. 36chs. Crane and mechanical equipment in use. (85/33)

SECTION B - TEMPORARY ENGINEERING WORKS - continued

At or between	Lines affected	Remarks
---------------	----------------	---------

LIVERPOOL STREET TO NORWICH - continued

UNTIL FURTHER NOTICE - continued

67	Trowse Swing Bridge and Thorpe Jn	Down and Up <u>Between Trains</u>	07 30 to 18 00. Construction work. 123½m.p. Crane and mechanical equipment in use. (86/3)
----	-----------------------------------	--------------------------------------	---

FRIDAY 5 TO MONDAY 8 DECEMBER

68	Bethnal Green and Bow Jn	Down and Up Main BLOCKED	23 00 Fri to 05 00 Mon. Bridgework (No. 46), signalling work and overhead line work. Mechanical equipment in use. <u>Isolation of electrical sections 311B, 312B.</u> 23 00 Fri to 00 15 Sat Trains to <u>travel over Electric lines.</u> 00 15 to 12 00 Sat. Diesel trains <u>to/from Stratford direction to travel over Up Electric (between Bow Jn and Wheler Street Jn)/Up Main (between Wheler Street Jn and Liverpool Street) line under single line working.</u> Trains to/from Hackney Downs direction to travel over <u>Suburban lines between Liverpool Street and Bethnal Green (Country End).</u> 12 00 Sat to 00 01 Mon LH70 22 51 Liverpool Street to <u>Peterborough, 1Y02 02 20 Liverpool Street to Stowmarket, 1W46 03 15 Liverpool Street to Shenfield and 1K06 03 45 Liverpool Street to Southend Victoria diverted via Tottenham Hale. (See Section 'D').</u> 00 01 to 05 00 Mon. Trains to/from <u>Stratford direction to travel over Up Electric (between Bow Jn and Wheler Street Jn)/Up Main (between Wheler Street Jn and Liverpool Street) line under single line working.</u> Trains to/from Hackney Downs direction to <u>travel over Suburban lines between Liverpool Street and Bethnal Green (Country End).</u>
----	--------------------------	-----------------------------	--

SECTION B - TEMPORARY ENGINEERING WORKS - continued

At or between	Lines affected	Remarks
---------------	----------------	---------

LIVERPOOL STREET TO NORWICH - continued

SATURDAY 6 DECEMBER

69 Liverpool Street Station	Platforms 16 and 17 BLOCKED	00 15 to 12 00. Construction work. Mechanical equipment in use. <u>Isolation of electrical sections 301D, 302B. Trains to be replatformed as necessary.</u>
70 Liverpool Street Station	Platforms 8, 9 and 10 BLOCKED Platform 7 and London End Entry/Exit to/from Locomotive Holding Sidings BLOCKED to electric trains	05 00 to 12 30. Repairs to station roof. <u>Isolation of electrical sections 305CEFGH. Trains to be replatformed as necessary.</u>

SECTION B - TEMPORARY ENGINEERING WORKS - continued

At or between	Lines affected		Remarks
<u>LIVERPOOL STREET TO NORWICH - continued</u>			
<u>SATURDAY 6 TO SUNDAY 7 DECEMBER</u>			
71	Liverpool Street and Bethnal Green	Down and Up Suburban BLOCKED to electric trains	12 30 Sat to 23 00 Sun) Repairs to station roof and construction work.
	Liverpool Street Station	Platforms 9 and 10 BLOCKED	12 30 to 23 00 Sat) Mechanical equipment in use. Isolation of electrical sections 305 and 306. 12 30 to 23 00 Sat) Electric trains to travel over
		Platforms 9 and 10 BLOCKED to electric trains	23 00 Sat to 04 15) Electric trains to travel over
		Platforms 1 to 6 inc. (and approaches) and Platforms 7 and 8 BLOCKED	12 30 Sat to 23 00 Sun) Main or Electric lines. Possession to be given up for passage of 3C01 11 22 Colchester to
		Locomotive Holding Sidings BLOCKED to electric trains	12 30 Sat to 23 00 Sun) Liverpool Street and 5H14 14 26 Liverpool Street to Broxbourne
		Platforms 9 and 10 BLOCKED	04 15 to 23 00 Sun) to/from Platform 10. Other trains
			<u>to be replatformed as necessary. 23 00 Sat to 04 15. Electric trains to travel over Main or Electric lines. Trains to be replatformed as necessary. Diesel trains travelling to/from platforms 9 and 10 and Main lines NOT affected. 04 15 to 23 00 Sun Electric trains to travel over Main or Electric lines. Trains to be replatformed as necessary.</u>

SECTION B - TEMPORARY ENGINEERING WORKS - continued

At or between	Lines affected	Remarks
<u>LIVERPOOL STREET TO NORWICH - continued</u>		
SATURDAY/SUNDAY 6/7 DECEMBER		
72	Gidea Park Jn and Shenfield (London End Jn)	Down and Up Main BLOCKED Down and Up Electric
		23 59 to 18 00. Drainage, loading materials and overhead line work. Mechanical equipment in use. <u>Isolation of electrical sections 331D, 332A. Trains to travel over Electric lines.</u>
73	Colchester	All
		22 00 to 07 00. Signalling work
74	Haughley Jn and Diss	Down and Up BLOCKED
		23 00 to 07 00. Trolleying materials. 83 and 93m.p. <u>Possession to be given up for passage of trains.</u>
75	Diss and Flordon	Down BLOCKED
		23 50 to 07 00. Construction work (overhead line).
76	Flordon and Trowse Tard	Up BLOCKED Down BLOCKED
		23 55 to 07 00)Track maintenance,)track renewal, 23 55 to 15 00)formation renewal,)construction work)(overhead line),)earthwork and loading)materials.)Crane and mechanical)equipment in use.) <u>23 55 Sat to 07 00</u>) <u>Possession to be given</u>) <u>up for passage of 1P04</u>) <u>02 10 Liverpool Street</u>) <u>to Yarmouth over Up</u>) <u>line under single line</u>) <u>working. 07 00 to</u>) <u>15 00 Sun Single line</u>) <u>working over Up line.</u>
77	Trowse Yard and Norwich Station	Down and Up Main/ Single/'D'/'W' line and 'C' line BLOCKED
		23 59 to 06 45. Construction work (overhead line) and loading materials. <u>Possession to be given up for passage of 1P04 02 10 Liverpool Street to Yarmouth.</u>

SECTION B - TEMPORARY ENGINEERING WORKS - continued

At or between	Lines affected	Remarks
<u>LIVERPOOL STREET TO NORWICH - continued</u>		
SATURDAY/SUNDAY 6/7 AND SUNDAY 7 DECEMBER - continued		
80 New Hall G.F. and Witham	Up BLOCKED Down BLOCKED	23 15 Sat to 13 30)Track maintenance,)track renewal, 00 10 to 15 15 Sun)formation renewal,)drainage and)overhead line work.)Crane and)mechanical)equipment in use.) <u>23 15 Sat to 13 30.</u>) <u>Possession to be</u>) <u>given up for</u>) <u>passage of 1Y02</u>) <u>02 20 Liverpool</u>) <u>Street to</u>) <u>Stowmarket</u>) <u>over Up line under</u>) <u>single line</u>) <u>working. 13 30 to</u>) <u>15 15 Sun Single</u>) <u>line working over</u>) <u>Up line.</u>
81 Manningtree North Jn and Halifax Jn	Up BLOCKED Down BLOCKED	23 00 Sat to 05 45)Track maintenance,)track renewal and 00 40 to 07 30 Sun)loading materials.)Mechanical)equipment in use.) <u>Possession to be</u>) <u>given up for</u>) <u>passage of 1Y02</u>) <u>02 20 Liverpool</u>) <u>Street to</u>) <u>Stowmarket over</u>) <u>Down line.</u>

SECTION B - TEMPORARY ENGINEERING WORKS - continued

<u>At or between</u>	<u>Lines affected</u>	<u>Remarks</u>
<u>LIVERPOOL STREET TO NORWICH - continued</u>		
<u>SATURDAY 6 TO MONDAY 8 DECEMBER</u>		
82 Bethnal Green and Bow Jn	Up Electric	00 15 to 12 00 Sat)Bridgework (No. 46),
	Down Electric	00 15 Sat to 05 00 Mon)overhead line
	BLOCKED)work and
	Up Electric	12 00 Sat to 00 01 Mon)signalling
	BLOCKED)work.
	Up Electric	00 01 to 05 00 Mon)Mechanical
)equipment in
Bethnal Green and Stratford (London End)	Up Electric	00 15 Sat to 00 01 Mon)use.
	BLOCKED to)00 15 Sat to
	electric trains)00 01 Mon.
)Isolation of
	Down Electric	00 15 Sat to 05 00 Mon)electrical
	BLOCKED to)sections 309A,
	electric trains)310B. 00 15 to
)12 00 Sat
)Diesel trains
)to/from
)Stratford
		<u>direction to travel over Up Electric</u>
		<u>(between Bow Jn and Wheler Street</u>
		<u>Jn)/Up Main (between Wheler Street Jn</u>
		<u>and Liverpool Street) line under</u>
		<u>single line working. Trains to/from</u>
		<u>Hackney Downs direction to travel</u>
		<u>over Suburban lines between Liverpool</u>
		<u>Street and Bethnal Green (Country</u>
		<u>End). 12 00 Sat to 00 01 Mon 1H70</u>
		<u>22 51 Liverpool Street to</u>
		<u>Peterborough, 1Y02 02 20 Liverpool</u>
		<u>Street to Stowmarket, 1W46 03 15</u>
		<u>Liverpool Street to Shenfield and</u>
		<u>1K06 03 45 Liverpool Street to</u>
		<u>Southend Victoria diverted via</u>
		<u>Tottenham Hale. (See Section 'D').</u>
		<u>00 01 to 05 00 Mon Trains to/from</u>
		<u>Stratford direction to travel over Up</u>
		<u>Electric (between Bow Jn and Wheler</u>
		<u>Street Jn)/Up Main (between Wheler</u>
		<u>Street Jn and Liverpool Street) line</u>
		<u>under single line working. Trains</u>
		<u>to/from Hackney Downs direction to</u>
		<u>travel over suburban lines between</u>
		<u>Liverpool Street and Bethnal Green</u>
		<u>(Country End).</u>

SECTION B - TEMPORARY ENGINEERING WORKS - continued

<u>At or between</u>	<u>Lines affected</u>	<u>Remarks</u>
----------------------	-----------------------	----------------

LIVERPOOL STREET TO NORWICH - continued

SUNDAY 7 DECEMBER

83	Romford Jn	Up Main	08 00 to 17 00. Signalling work.
84	Shenfield and Witham	All BLOCKED to electric trains	00 10 to 13 30. In connection with engineering work. <u>Isolation of electrical sections 333, 334, 335 and 336.</u>
85	Witham and Kelvedon	Down and Up BLOCKED	00 01 to 05 00. Track maintenance and track renewal 38m. 58chs. Mechanical equipment in use. <u>Possession to be given up for passage of trains.</u>
86	Colchester Station	Down and Up Goods and Platform 1 BLOCKED Carriage Sidings Nos. 5 and 6 and Carriage Washer Road BLOCKED to Electric trains	00 05 to 16 00. Track maintenance, track renewal and overhead line work. Crane and mechanical equipment in use. Isolation of electrical sections 340FGHK. <u>Trains to travel over other lines.</u>
87	Flordon and Diss	Up BLOCKED to electric trains	07 00 to 16 00. In connection with engineering work. <u>Isolation of electrical sections 351A and 351Y (buffer section).</u>

SUNDAY/MONDAY 7/8 DECEMBER

88	Trowse Jn and Trowse Swing Bridge	Down Main BLOCKED	23 05 to 04 05. Track maintenance between crossover at 113m 34chs and Trowse Swing Bridge. Mechanical equipment in use. <u>Possession to be given up for passage of trains.</u>
----	-----------------------------------	----------------------	---

SUNDAY 7 TO FRIDAY 12 DECEMBER

89	Thorpe Jn and Norwich Station	'C' Line BLOCKED 'W' line <u>Between Trains</u>	23 45 Sun to Thu to 05 00 Mon to Fri. Construction work (overhead line).
----	-------------------------------	--	--

SECTION B - TEMPORARY ENGINEERING WORKS - continued

At or between	Lines affected	Remarks
---------------	----------------	---------

LIVERPOOL STREET TO NORWICH - continued

SUNDAY 7 TO FRIDAY 12 DECEMBER

90	Norwich and Whitlingham Jn	'A' and 'E' lines/Down and Up Lowestoft/ Main BLOCKED)23 30 Sun to Thu to 05 00 Mon to Fri.)Construction work (overhead line).) <u>Possession to be given up for passage</u>) <u>of trains.</u>))
	Norwich Station	Platforms 4, 5 and 6 BLOCKED)))

MONDAY 8 DECEMBER

91	Liverpool Street Station	Platforms 16 and 17 BLOCKED	00 01 to 05 00. Construction work. Mechanical equipment in use. <u>Trains to be replatfoemed as</u> <u>necessary.</u>
92	Goodmayes Jn and Gidea Park Jn	Down and Up Main BLOCKED	01 00 to 05 00. Overhead line work. <u>Isolation of electrical sections</u> <u>323A, 324E, 327C, 328A. Trains to</u> <u>travel over electric lines.</u>
93	East Suffolk Jn and Haughley Jn	All BLOCKED to electric trains	01 30 to 04 30. In connection with overhead line work between Claydon LC and Stowmarket. <u>Isolation of</u> <u>electrical sections 345, 346, 347 and</u> <u>348.</u>
94	Claydon LC and Stowmarket	Down and Up BLOCKED	01 30 to 04 30. Overhead line work. <u>Possession to be given up for passage</u> <u>of diesel trains.</u>

MONDAY 8 TO THURSDAY 11 DECEMBER

95	Haughley Jn and Diss	Down BLOCKED	22 30 Mon to Wed to 04 15 Tue to Thu. Track maintenance. Mechanical equipment in use. <u>Single line</u> <u>working over Up line.</u>
----	-------------------------	-----------------	--

SECTION B - TEMPORARY ENGINEERING WORKS - continued

<u>At or between</u>	<u>Lines affected</u>	<u>Remarks</u>
<u>LIVERPOOL STREET TO NORWICH - continued</u>		
MONDAY 8 TO FRIDAY 12 DECEMBER		
96 Liverpool Street Station	Platform 10 BLOCKED	10 45 to 15 30 daily. Construction work. Mechanical equipment in use. <u>Isolation of electrical sections 305H. Trains to be replatformed as necessary.</u>
97 Trowse Jn and Trowse Swing Bridge	Down Main	08 40 to 16 00 daily. Track renewal. Crane and mechanical equipment in use.
98 Trowse Yard and Thorpe Jn	All BLOCKED	23 00 Mon to Thu to 05 00 Tue to Fri. Track renewal. Mechanical equipment in use. <u>Possession to be given up for passage of trains.</u>
99 Norwich Station	Platforms 2, 3 and 4 and Middle Siding BLOCKED	22 00 Mon to Thu to 05 30 Tue to Fri. Track maintenance and track renewal. Mechanical equipment in use. <u>Trains to be replatformed as necessary.</u>

MONDAY 8 TO SATURDAY 13 DECEMBER

100 Bethnal Green and Bow Jn	Down and Up Main BLOCKED	23 15 Mon to Fri to 05 00 Tue to Sat. Track maintenance and overhead line work. Mechanical equipment in use. <u>Isolation of electrical sections 311B, 312B. Trains to travel over Electric lines.</u>
------------------------------	-----------------------------	--

TUESDAY 9 AND WEDNESDAY 10 DECEMBER

101 Liverpool St. and Bethnal Green	Down and Up Electric BLOCKED)00 05 to 05 00 daily. Track)maintenance. Om 50chs. and Om 68chs.) <u>Trains to travel over Main or)Suburban lines and to be replatformed)as necessary.</u>
Liverpool St.	Approaches to Platforms 15, 16, 17 and 18 BLOCKED)))

SECTION B - TEMPORARY ENGINEERING WORKS - continued

At or between	Lines affected	Remarks
---------------	----------------	---------

LIVERPOOL STREET TO NORWICH - continued

TUESDAY 9 TO FRIDAY 12 DECEMBER

102	Liverpool Street Station	Platforms 16 and 17 BLOCKED	00 05 to 05 00 daily. Construction work. Mechanical equipment in use. <u>Isolation of electrical sections 301D, 302B. Trains to be replatformed as necessary.</u>
-----	--------------------------	--------------------------------	---

103	Witham and Kelvedon	Down Main and Down Passenger Loop BLOCKED	00 01 to 04 50 daily. Overhead line work. Mechanical equipment in use. <u>Isolation of electrical sections 338CD. Single line working over Up Main line.</u>
-----	---------------------	--	--

THURSDAY/FRIDAY 11/12 DECEMBER

104	Colchester Station	All BLOCKED	23 00 to 05 00. Track maintenance. Mechanical equipment in use. <u>Possession to be given up for passage of trains.</u>
-----	--------------------	----------------	---

105	Flordon and Trowse Jn	Down BLOCKED	22 50 to 04 50. Track maintenance between Flordon and crossover at 113m. 34chs. Mechanical equipment in use. <u>Single line working over Up line.</u>
-----	-----------------------	-----------------	---

NAVARINO ROAD JN TO NORTH WOOLWICH

UNTIL FURTHER NOTICE

106	Highbury and Homerton	All	07 30 to 18 00. Earthwork and construction work. Mechanical equipment in use. (86/1)
-----	-----------------------	-----	--

SUNDAY 7 DECEMBER

107	Dalston Western Jn and Hackney Central	All BLOCKED to AC electric trains	00 01 to 08 00. In connection with engineering work between Dalston Western Jn and Lea Jn. <u>Isolation of electrical sections 314DEFJK.</u>
-----	--	--------------------------------------	--

108	Dalston Western Jn and Lea Jn	All BLOCKED	00 01 to 08 00. Track maintenance and demolition work. Crane and mechanical equipment in use. <u>Isolation of DC electrical sections 707, 708, 709B, 710A.</u>
-----	-------------------------------	----------------	--

SECTION B - TEMPORARY ENGINEERING WORKS - continued

At or between	Lines affected	Remarks
---------------	----------------	---------

CHANNELSEA SOUTH JN TO STRATFORD CENTRAL JN WEST

UNTIL FURTHER NOTICE

109	Channelsea South Jn and Stratford Central Jn West	Down and Up BLOCKED to electric trains	In connection with engineering work. (86/14)
-----	---	--	---

FOREST GATE JN TO WOODGRANGE PARK JN

SUNDAY 7 DECEMBER

110	Forest Gate Jn and Woodgrange Park Station (Country End)	Down and Up BLOCKED	00 50 to 17 00. Overhead line work. Mechanical equipment in use. <u>Possession to be given up for passage of Engineers' trains.</u>
-----	--	------------------------	--

SUNDAY 7 TO MONDAY 8 DECEMBER

111	Forest Gate Jn and Barking Tilbury Line Jn West	Down and Up BLOCKED to electric trains	00 50 Sun to 04 00 Mon. In connection with engineering work. <u>Isolation of electrical sections 512AB, 513EF.</u>
-----	---	--	--

ROMFORD TO UPMINSTER

SUNDAY 7 DECEMBER

112	Romford Jn	Single	08 00 to 17 00. Signalling work.
-----	------------	--------	----------------------------------

SHENFIELD JN TO SOUTHEND VICTORIA

UNTIL FURTHER NOTICE

113	Billericay	Down and Up	07 30 to 17 30. Construction work and platform work. Mechanical equipment in use. (86/19)
114	Wickford Station	All	Platform work and earthwork. (85/63)
115	Wickford Jn	All	08 00 to 17 00. Signalling work. (85/41)

SECTION B - TEMPORARY ENGINEERING WORKS - continued

At or between	Lines affected	Remarks
---------------	----------------	---------

SHENFIELD JN TO SOUTHEND VICTORIA - continued

UNTIL FURTHER NOTICE - continued

116	Rayleigh and Hockley	Down	08 00 to 17 00. Earthwork 34½ and 34¾ m.p. Mechanical equipment in use. (85/61)
117	Southend Victoria Station	All	08 00 to 18 00. Repairs to station roof. (86/20)

TUESDAY 9 AND WEDNESDAY 10 DECEMBER

118	Billericay and Wickford Station	Down BLOCKED	00 01 to 04 30. Track maintenance. Mechanical equipment in use. <u>Single line working over Up line.</u>
-----	---------------------------------	-----------------	--

THURSDAY 11 AND FRIDAY 12 DECEMBER

119	Wickford Station and Hockley	Down BLOCKED	00 20 to 04 45. Track maintenance and bridgework (No.773). Mechanical equipment in use. <u>Single line working over Up line.</u>
-----	------------------------------	-----------------	--

WICKFORD JN TO SOUTHMINSTER

UNTIL FURTHER NOTICE

120	Wickford Jn	All	08 00 to 17 00. Signalling work. (85/41)
121	Fambridge Station	Single	07 30 to 18 00. Platform work. (85/55)
122	Burnham-on-Crouch	Single	07 30 to 18 00. Earthwork. 43m 24chs. (85/30)

SATURDAY 6 DECEMBER

123	Wickford Jn and Southminster	Single BLOCKED	00 01 to 04 45. Unloading materials.
-----	------------------------------	-------------------	--------------------------------------

SECTION B - TEMPORARY ENGINEERING WORKS - continued

At or between	Lines affected	Remarks
---------------	----------------	---------

WICKFORD JN TO SOUTHMINSTER - continued

SUNDAY 7 DECEMBER

124	Wickford Jn and Southminster	Single BLOCKED	00 30 to 08 00. Track maintenance. Mechanical equipment in use.
-----	------------------------------------	-------------------	--

WITHAM TO BRAINTREE

UNTIL FURTHER NOTICE

125	Witham and Braintree	Single	07 00 to 18 00. Construction work (Bridge No. 2102B). (86/19)
-----	-------------------------	--------	---

FRIDAY/SATURDAY 5/6 DECEMBER

126	Witham and Braintree	Single BLOCKED	23 40 to 05 30. Bridgework (No.2102B). Mechanical equipment in use. <u>Isolation of electrical sections 379.</u>
-----	-------------------------	-------------------	--

SUNDAY 7 DECEMBER

127	Witham and Braintree	Single BLOCKED	00 10 to 08 45. Bridgework (No.2102B). Mechanical equipment in use. <u>Isolation of electrical section 379.</u>
-----	-------------------------	-------------------	---

MONDAY 8 TO SATURDAY 13 DECEMBER

128	Witham and Braintree	Single BLOCKED	23 40 Mon to Fri to 05 30 Tue to Sat. Bridgework (No.2102B). Mechanical equipment in use. <u>Isolation of electrical sections 379.</u>
-----	-------------------------	-------------------	--

COLCHESTER TO CLACTON

SATURDAY/SUNDAY 6/7 AND SUNDAY 7 DECEMBER

129	Hythe Station and Great Bentley	Down and Up BLOCKED Down and Up	23 20 Sat to 07 45)Level crossing road)repairs (Colchester 07 45 to 16 00 Sun)Road LC) and)overhead line work.)Mechanical)equipment in use.
-----	---------------------------------------	---------------------------------------	--

SECTION B - TEMPORARY ENGINEERING WORKS - continued

At or between	Lines affected	Remarks
---------------	----------------	---------

COLCHESTER TO CLACTON - continued

SUNDAY 7 DECEMBER

130	Colchester Jn and Clacton	All BLOCKED to electric trains	00 10 to 07 15. In connection with engineering work. <u>Isolation of electrical sections 381, 382, 383, 384, 385 and 386.</u>
131	Thorpe-le-Soken and Clacton	Down and Up BLOCKED	00 01 to 07 15. Track renewal and unloading rails. 68m. 46chs. and 68 ³ m.p. Mechanical equipment in use.

MONDAY 8 TO WEDNESDAY 10 DECEMBER

132	Colchester Jn and Thorpe-le-Soken	Down BLOCKED to electric trains	23 40 Mon and Tue to 04 45 Tue and Wed. In connection with engineering electric trains work between East Gate Jn. and Thorpe-le-Soken. <u>Isolation of electrical sections 382C, 384AB.</u>
-----	-----------------------------------	------------------------------------	---

MONDAY 8 TO FRIDAY 12 DECEMBER

133	East Gate Jn and Thorpe-le-Soken	Down and Up BLOCKED	23 40 Mon to Thu to 04 45 Tue to Fri. Track maintenance and trimming lineside vegetation. Mechanical equipment in use. <u>Possession to be given up for passage of Freight trains to/from Hythe.</u>
-----	----------------------------------	------------------------	--

WEDNESDAY 10 TO FRIDAY 12 DECEMBER

134	Hythe and Thorpe-le-Soken	Down BLOCKED to electric trains	23 40 Wed and Thu to 04 45 Thu and Fri. In connection with engineering work between East Gate Jn. and Thorpe-le-Soken. <u>Isolation of electrical sections 384BC.</u>
-----	---------------------------	------------------------------------	---

EAST GATE JN. TO ST. BOTOLPHS

SUNDAY 7 DECEMBER

135	East Gate Jn and St. Botolphs	All BLOCKED to electric trains	00 10 to 07 15. In connection with engineering work. <u>Isolation of electrical sections 381.</u>
-----	-------------------------------	-----------------------------------	---

SECTION B - TEMPORARY ENGINEERING WORKS - continued

At or between	Lines affected	Remarks
---------------	----------------	---------

COLNE JN TO HYTHE JN

SUNDAY 7 DECEMBER

136 Colne Jn and Hythe Jn	Down and Up BLOCKED to electric trains	00 10 to 07 15. In connection with engineering work. <u>Isolation of electrical sections 381.</u>
---------------------------	--	---

THORPE-LE-SOKEN TO WALTON-ON-NAZE

SUNDAY 7 DECEMBER

137 Thorpe-le-Soken and Walton-on-Naze	Single BLOCKED	00 10 to 07 15. Trimming lineside vegetation. Mechanical equipment in use. <u>Isolation of electrical sections 387.</u>
--	-------------------	---

MANNINGTREE SOUTH JN TO HARWICH

UNTIL FURTHER NOTICE

138 Wrabness and Mistley	Up	07 30 to 17 00. Earthwork. 64m. 46chs. and 64m. 15chs. Mechanical equipment in use. (85/65)
--------------------------	----	--

FRIDAY/SATURDAY 5/6 DECEMBER

139 Manningtree South Jn and Harwich Town	All BLOCKED electric trains	23 45 to 04 30. In connection with engineering work between Wrabness and Harwich Town. <u>Isolation of electrical sections 391 and 392.</u>
140 Wrabness and Harwich Town	All BLOCKED	23 35 to 05 15. Overhead line work, track maintenance and unloading materials. Mechanical equipment in use. <u>Possession to be given up for passage of Diesel trains.</u>

SATURDAY/SUNDAY 6/7 DECEMBER

141 Parkeston Goods Jn and Parkeston East LC	All BLOCKED	23 20 to 06 45. Track maintenance and unloading materials. Mechanical equipment in use.
---	----------------	---

SECTION B - TEMPORARY ENGINEERING WORKS - continued

At or between	Lines affected	Remarks
---------------	----------------	---------

MANNINGTREE SOUTH JN TO HARWICH - continued

MONDAY 8 TO THURSDAY 11 DECEMBER

142	Parkeston Goods Jn and Parkeston East LC	All BLOCKED	23 35 Mon to Wed to 05 15 Tue to Thu. Track maintenance and unloading materials. Mechanical equipment in use. <u>Possession to be given up for passage of trains.</u>
-----	---	----------------	--

EAST SUFFOLK JN TO OULTON BROAD NORTH JN

UNTIL FURTHER NOTICE

143	Westerfield Jn and Woodbridge	Down and Up BLOCKED	07 00 to 19 00. Bridgework (No.418A). 76m. 65chs. Mechanical equipment in use. <u>Possession to be given up for passage of trains.</u>
-----	----------------------------------	------------------------	--

(86/33)

SATURDAY/SUNDAY 6/7 DECEMBER

144	Westerfield and Woodbridge	Down and Up BLOCKED	23 10 to 10 30. Loading rails. Crane and mechanical equipment in use.
-----	-------------------------------	------------------------	---

WESTERFIELD JN TO FELIXSTOWE

UNTIL FURTHER NOTICE

145	Westerfield Jn and Derby Road	Single	08 00 to 16 00. Earthwork. 73m. 13chs. and 73 $\frac{1}{2}$ m.p.
-----	----------------------------------	--------	---

(85/61)

146	Derby Road and Felixstowe Beach Jn	Single	07 30 to 17 00. Earthwork. 82% and 83m.p. Mechanical equipment in use. <u>Until 17 00 Sunday 7 December.</u>
-----	--	--------	--

(86/1)

147	Derby Road and Felixstowe Beach Jn	Single	07 30 to 17 00. Earthwork and bridgework (Nos. 1083 and 1092). 73m. 18chs and 83m.p. Mechanical equipment in use. <u>From 07 30 Monday 8 December.</u>
-----	--	--------	--

(86/37)

SECTION B - TEMPORARY ENGINEERING WORKS - continued

At or between	Lines affected	Remarks
---------------	----------------	---------

NORWICH TO LOWESTOFT - continued

SUNDAY 7 TO FRIDAY 12 DECEMBER - continued

153	Norwich and Whitlingham Jn	'A' and 'E' lines/Down and Up Lowestoft/Main BLOCKED)23 30 Sun to Thu to 05 00 Mon to)Fri. Construction work (overhead)line). <u>Possession to be given)up for passage of trains.</u>))))
	Norwich Station	Platforms 4, 5 and 6 BLOCKED))))

MONDAY 8 TO FRIDAY 12 DECEMBER

154	Norwich Station	Platforms 2, 3, and 4 and Middle Siding BLOCKED	22 00 Mon to Thu to 05 30 Tue to Fri. Track maintenance and track renewal. Mechanical equipment in use. <u>Trains to be replatformed as necessary.</u>
155	Reedham Jn and Oulton Broad North	Down and Up BLOCKED	23 55 Mon to Thu to 05 45 Tue to Fri Track maintenance. Mechanical equipment in use.

WHITLINGHAM JN TO CROMER

UNTIL FURTHER NOTICE

156	Whitlingham Jn and Wroxham	Down and Up	07 30 to 16 30. Bridgework (No. 365). 3m. 48chs. (86/6)
157	Cromer Station	Platforms 1 and 2	Platform work. (86/15)

SUNDAY 7 DECEMBER

158	North Walsham and Cromer	Single	07 30 to 14 00. Unloading materials.
-----	--------------------------	--------	--------------------------------------

CROMER TO SHERINGHAM

UNTIL FURTHER NOTICE

159	Cromer Station	Platforms 1 and 2	Platform work. (86/15)
-----	----------------	-------------------	---------------------------

SECTION B - TEMPORARY ENGINEERING WORKS - continued

At or between	Lines affected	Remarks
<u>BRUNDALL JN TO YARMOUTH VIA ACLE</u>		
UNTIL FURTHER NOTICE		
160 Brundall Jn and Yarmouth	All	08 00 to 16 00. Signalling work. (86/30)
<u>REEDHAM JN TO YARMOUTH</u>		
UNTIL FURTHER NOTICE		
161 Reedham Jn and Yarmouth	All	08 00 to 16 00. Signalling work. (86/30)
<u>BETHNAL GREEN JN TO KING'S LYNN</u>		
UNTIL FURTHER NOTICE		
162 Cambridge Heath Station	Down and Up Suburban	08 00 to 17 00. Platform work. 1m. 6lchs. Mechanical equipment in use. (<u>See Section 'D'</u>). (86/24)
163 London Fields Station	Down and Up Suburban	Platform work. 2m. 35chs. Mechanical equipment in use. (<u>See Section 'D'</u>). (86/27)
164 Enfield Lock Station	Up	08 00 to 16 30. Platform work. 11m. 65chs. Mechanical equipment in use. (86/28)
165 Enfield Lock and Waltham Cross	Down and Up	07 00 to 18 00. Bridgework (No.1418C). 12m. 34chs. Crane and mechanical equipment in use. (85/59)
166 Bishops Stortford (Country end) and Stansted	Down and Up Main BLOCKED to electric trains	Overhead line work. <u>Isolation of electrical sections 427, 428 (buffer section).</u> (85/41) <u>Until 18 00 Saturday 6 December</u>
167 Bishops Stortford and Cambridge (North)	All	07 00 to 18 00. Construction work (overhead line). Mechanical equipment in use. (85/21) <u>Until 18 00 Sunday 7 December</u>

SECTION B - TEMPORARY ENGINEERING WORKS - continued

At or between	Lines affected	Remarks
<u>BETHNAL GREEN JN TO KING'S LYNN - continued</u>		
UNTIL FURTHER NOTICE - continued		
168 Bishops Stortford and Chesterton Jn	All	08 00 to 18 00. Signalling work. (86/35)
169 Whittlesford Station	Down and Up	Platform work. 49m. 02chs. Mechanical equipment in use. (86/29)
170 Chesterton Jn and Milton Fen LC	Down and Up	07 30 to 18 00. Bridgework (No. 1550B). 58m. 63chs. Mechanical equipment in use. (86/24)
FRIDAY/SATURDAY 5/6 DECEMBER		
171 Stansted and Bishops Stortford	Up Main BLOCKED	23 00 to 04 45. Overhead line work. Mechanical equipment in use. <u>Isolation of electrical sections 417AB, 427. Single line working over Down Main line.</u>
SATURDAY 6 DECEMBER		
172 Northumberland Park and Cheshunt Jn	All	01 00 to 03 30. Signalling work. Points and signals disconnected.
173 Coldham Lane Jn and Waterbeach	All <u>Between Trains</u>	07 00 to 16 00. Bridgework (Nos.1547, 1548, 1548A, 1549 and 1550A).
SATURDAY/SUNDAY 6/7 DECEMBER		
174 Bishops Stortford (London End) and Stansted	Platform 1/Down Main and Up Main BLOCKED to electric trains	18 00 to 10 00. In connection with engineering work between Bishops Stortford and Audley End. <u>Isolation of electrical sections 417AB, 418C, 427 and 428 (buffer sections).</u>

SECTION B - TEMPORARY ENGINEERING WORKS - continued

At or between	Lines affected	Remarks
---------------	----------------	---------

BETHNAL GREEN JN TO KING'S LYNN - continuedSATURDAY/SUNDAY 6/7 DECEMBER - continued

175	Bishops Stortford and Audley End	Up Main BLOCKED Down Main BLOCKED	22 30 to 08 30) Construction work (overhead line). 23 50 to 09 00) 30% and 4m.p. Mechanical equipment in use. Possession to be given up for passage of 1P04 02 10 Liverpool Street to Yarmouth and 1H02 03 10 Liverpool Street to King's Lynn over Down Main line.
176	Audley End and Great Chesterford	Up BLOCKED Down BLOCKED	22 30 to 08 15) Earthwork and trimming lineside vegetation. 23 45 to 09 00) 42 and 45 $\frac{1}{2}$ m.p. Mechanical equipment in use. Possession to be given up for passage of 1P04 02 10 Liverpool Street to Yarmouth and 1H02 03 10 Liverpool Street to King's Lynn over Down line.
177	Shepreth Branch Jn and Coldham Lane Jn	All <u>Between Trains</u>	22 00 to 08 00. Construction work. (overhead line). 53% and 56 $\frac{1}{2}$ m.p. Mechanical equipment in use.

SATURDAY/SUNDAY 6/7 AND SUNDAY 7 DECEMBER

178	Great Chesterford and Shepreth Branch Jn	Up Main BLOCKED Down Main BLOCKED	22 20 Sat to 08 15) Construction work (overhead line). 00 05 to 09 00 Sun) 45% and 53m.p. Mechanical equipment in use. Possession to be given up for passage of 1P04 02 10 Liverpool Street to Yarmouth and 1H02 03 10 Liverpool Street to King's Lynn over Down Main line.
-----	---	--	---

SECTION B - TEMPORARY ENGINEERING WORKS - continued

At or between	Lines affected	Remarks
---------------	----------------	---------

BETHNAL GREEN JN TO KING'S LYNN - continued

SUNDAY 7 DECEMBER

179 Bethnal Green Station (Country End)	Down Fast and Down and Up Suburban	08 00 to 16 00. Signalling work (No. 63 points).
---	------------------------------------	--

SUNDAY/MONDAY 7/8 DECEMBER

180 Bishops Stortford (London End) and Stansted	Platform 1/ Down Main and Up Main BLOCKED to electric trains	10 00 Sun to 06 00 Mon. Overhead line work. <u>Isolation of electrical sections 417A, 418C, 427 and 428 (buffer sections).</u>
---	---	--

MONDAY 8 DECEMBER

181 Clapton Jn and Broxbourne Jn (Country End)	All BLOCKED to electric trains	01 00 to 03 55. In connection with overhead line work between Brimsdown and Cheshunt Station. <u>Isolation of electrical sections 411, 412, 413 and 414.</u>
--	-----------------------------------	--

182 Brimsdown and Cheshunt Station	Down and Up Main BLOCKED	01 00 to 03 55. Overhead line work. <u>Possession to be given up for passage of diesel trains.</u>
------------------------------------	-----------------------------	--

MONDAY 8 TO FRIDAY 12 DECEMBER

183 Cambridge (North) and Coldham Lane Jn	Down Goods Loop North BLOCKED Down Main	08 00 to 16 00 daily. Earthwork. 56 $\frac{1}{2}$ and 56 $\frac{1}{2}$ m.p. Mechanical equipment in use. <u>Isolation of electrical sections 426G.</u>
---	---	--

READING LANE JN TO NAVARINO ROAD JN (GRAHAM ROAD CURVE)

SUNDAY 7 DECEMBER

184 Reading Lane Jn and Navarino Road Jn	Single BLOCKED to electric trains	00 01 to 08 00. In connection with engineering work between Dalston Western Jn and Lea Jn. <u>Isolation of electrical sections 314C.</u>
--	--------------------------------------	--

SECTION B - TEMPORARY ENGINEERING WORKS - continued

At or between	Lines affected	Remarks
---------------	----------------	---------

HACKNEY DOWNS NORTH JN. TO ENFIELD TOWN

SUNDAY 7 DECEMBER

185	Seven Sisters and Enfield Town/Cheshunt Jn	All BLOCKED	00 05 to 22 00. Formation renewal, trimming lineside vegetation, track maintenance, track renewal, overhead line work and repairs to platform awnings (Lower Edmonton Station). Mechanical equipment in use. <u>Trains diverted via Clapton. 00 05 to 20 00</u> <u>Isolation of electrical sections 401AB, 402DEF, 403 and 404.</u>
-----	--	-------------	--

TUESDAY 9 TO FRIDAY 12 DECEMBER

186	Seven Sisters and Enfield Town/Cheshunt Jn	All BLOCKED	00 05 to 04 35 daily. Track maintenance and overhead line work. Mechanical equipment in use. <u>Isolation of electrical sections 401AB, 402DEF, 403 and 404. Trains diverted via Clapton.</u>
-----	--	-------------	---

BURY STREET JN TO CHESHUNT

SUNDAY 7 DECEMBER

187	Seven Sisters and Enfield Town/Cheshunt Jn	All BLOCKED	00 05 to 22 00. Formation renewal, trimming lineside vegetation, track maintenance, track renewal, overhead line work and repairs to platform awnings (Lower Edmonton Station). Mechanical equipment in use. <u>Trains diverted via Clapton. 00 05 to 20 00</u> <u>Isolation of electrical sections 401AB, 402DEF, 403 and 404.</u>
-----	--	-------------	--

TUESDAY 9 TO FRIDAY 12 DECEMBER

188	Seven Sisters and Enfield Town/Cheshunt Jn	All BLOCKED	00 05 to 04 35 daily. Track maintenance and overhead line work. Mechanical equipment in use. <u>Isolation of electrical sections 401AB, 402DEF, 403 and 404. Trains diverted via Clapton.</u>
-----	--	-------------	---

SECTION B - TEMPORARY ENGINEERING WORKS - continued

At or between	Lines affected	Remarks
<u>BROXBOURNE JN TO HERTFORD EAST</u>		
UNTIL FURTHER NOTICE		
189 Rye House and St. Margarets	Down and Up	08 00 to 18 00. Bridgework (No. 2035A). 19m. 66chs. Mechanical equipment in use. (85/60)
* MONDAY 8 DECEMBER		
190 Broxbourne Jn and St. Margarets	Down and Up BLOCKED to electric trains	01 00 to 03 55. In connection with overhead line work. <u>Isolation of electrical sections 414.</u>
TUESDAY 9 DECEMBER		
191 Broxbourne Jn and Hertford East	All BLOCKED	00 35 to 04 50. Bridgework (No. 2035A). 19m. 66chs. Crane and mechanical equipment in use. <u>Isolation of electrical sections 434 and 435.</u>
WEDNESDAY 10 TO FRIDAY 12 DECEMBER		
192 Broxbourne Jn and Hertford East	All BLOCKED	00 35 to 05 00 daily. Loading materials and bridgework (No. 2035A). Crane and mechanical equipment in use. <u>00 35 to 04 50 daily Isolation of electrical sections 434 and 435.</u>
<u>COLDHAM LANE JN TO HAUGHLEY JN</u>		
UNTIL FURTHER NOTICE		
193 Bury St. Edmunds Station	Down	08 00 to 15 00. Repairs to platform awnings. (86/18)
SATURDAY/SUNDAY 6/7 DECEMBER		
194 Haughley Jn and Elmswell	Up BLOCKED Down BLOCKED	22 00 to 13 15)Track maintenance.)Mechanical equipment 23 15 to 13 15)in use.)

SECTION B - TEMPORARY ENGINEERING WORKS - continued

At or between	Lines affected	Remarks
---------------	----------------	---------

COLDHAM LANE JN TO HAUGHLEY JN - continued

MONDAY/TUESDAY 8/9 DECEMBER

195	Chippenham Jn and Bury St Edmunds	Down BLOCKED	23 00 to 05 15. Track maintenance. Mechanical equipment in use. <u>Single line working over Up line.</u>
-----	---	-----------------	--

TUESDAY/WEDNESDAY 9/10 DECEMBER

196	Bury St. Edmunds and Elmswell	Down BLOCKED	23 10 to 05 45. Track maintenance. Mechanical equipment in use. <u>Single line working over Up line.</u>
-----	-------------------------------------	-----------------	--

ELY NORTH JN TO PETERBOROUGH, CRESCENT JN

UNTIL FURTHER NOTICE

197	Black Bank and Crescent Jn	All	06 00 to 16 00. Signalling work. (86/35)
-----	-------------------------------	-----	---

SATURDAY 6 TO SUNDAY 7 DECEMBER

198	Chettisham and Manea	Down BLOCKED Up BLOCKED	11 30 Sat to 14 00 Sun) Bridgework) (Nos. 1813 and 11 45 Sat to 18 00 Sun) 1814) 78 and) 78 $\frac{3}{4}$ m.p. Crane) and mechanical) equipment in) use. <u>14 00</u>) <u>to 18 00 Sun.</u>) <u>Single line</u>) <u>working over</u>) <u>Down line.</u>
-----	-------------------------	----------------------------------	--

SUNDAY 7 DECEMBER

199	March West Jn and Whittlesea	Down and Up Main BLOCKED	00 05 to 08 00. Track maintenance. 87 and 89m.p. Mechanical equipment in use.
200	March West Jn and Whittlesea	Down Main <u>Between Trains</u>	08 00 to 16 00. Bridgework (No. 1829A). 91m. 72chs.
201	Three Horse Shoes and Whittlesea	Down and Up	08 00 to 15 00. Signalling work.

SECTION B - TEMPORARY ENGINEERING WORKS - continued

At or between	Lines affected	Remarks
---------------	----------------	---------

ELY NORTH JN TO PETERBOROUGH, CRESCENT JN - continued

THURSDAY 11 DECEMBER

202	Manea and Chettisham	Up BLOCKED	00 01 to 05 00. Bridgework (Nos. 1813 and 1814). 78% and 78m.p. <u>Single line working over Down line.</u>
-----	----------------------	---------------	--

ELY NORTH JN TO TROWSE JN

UNTIL FURTHER NOTICE

203	Thetford and Lakenheath	Up	08 00 to 16 00. Track maintenance. 87% and 85% m.p. (86/24)
204	Wymondham and Hethersett	Down and Up <u>Between Trains</u>	07 30 to 18 00. Bridgework, earthwork and construction work. 115m. 65chs. and 117m. 69chs. Cranes and mechanical equipment in use. (86/18)
205	Wymondham and Trowse Lower Jn	Down and Up	07 30 to 16 00. Signalling work. (85/24)
206	Hethersett and Trowse Lower Jn	Down and Up	07 30 to 16 00. Bridgework (Nos. 1638, 1640, 1640A and 349). 121m 17chs. and 122m 32chs. and track renewal. (86/36)

SATURDAY/SUNDAY 6/7 DECEMBER

207	Attleborough and Wymondham	Down and Up BLOCKED	22 45 to 07 15. Reballasting and undertrack excavation. 111m. 25chs. and 113m. 34chs. Crane and mechanical equipment in use. <u>Possession to be given up for passage of trains.</u>
208	Wymondham and Hethersett	Down and Up BLOCKED	23 45 to 07 00. Trolleying materials. 114m 15chs and 114% m.p. Mechanical equipment in use. <u>Possession to be given up for passage of trains.</u>

SECTION B - TEMPORARY ENGINEERING WORKS - continued

At or between	Lines affected	Remarks
<u>ELY NORTH JN TO TROWSE JN - continued</u>		
<u>SATURDAY/SUNDAY 6/7 DECEMBER - continued</u>		
209 Hethersett and Trowse Lower Jn	Up BLOCKED Down BLOCKED	21 30 to 16 00) Bridgework (Nos. 1640 and 1640A). 12 1/2 m.p. 23 35 to 07 15) Crane and mechanical equipment in use.) <u>23 35 Sat to 07 15</u>) <u>Possession to be given up for passage of 1P04</u>) <u>02 10 Liverpool Street to Yarmouth over Down line.</u>) <u>07 15 to 16 00 Sun</u>) <u>Single line working over Down line.</u>
<u>WEDNESDAY/THURSDAY 10/11 DECEMBER</u>		
210 Attleborough and Wymondham	Down and Up BLOCKED	23 15 to 06 30. Track maintenance. Mechanical equipment in use.
<u>WYMONDHAM TO NORTH ELMHAM</u>		
UNTIL FURTHER NOTICE		
211 Wymondham and North Elmham	Single	08 00 to 16 00. Trimming lineside vegetation. 1/2 and 6m.p. Mechanical equipment in use. (85/31)
<u>FENCHURCH STREET TO SHOEBURYNESS</u>		
UNTIL FURTHER NOTICE		
212 Fenchurch Street Station	All	Construction/demolition work. Mechanical equipment in use. (84/38)
213 Fenchurch Street and Stepney East	All	Construction work, and in connection with engineering work (Docklands Light Railway). Mechanical equipment in use. (See Section 'D'). (86/25)

SECTION B - TEMPORARY ENGINEERING WORKS - continued

At or between	Lines affected	Remarks
<u>FENCHURCH STREET TO SHOEBURYNESS - continued</u>		
UNTIL FURTHER NOTICE - continued		
214 Fenchurch Street and Gas Factory Jn	All	08 00 to 17 00. Signalling work. (86/1)
215 East Ham	Down and Up	Construction work. Mechanical equipment in use. (83/51)
216 East Ham and Barking (London End)	Down and Up	Erecting scaffolding in connection with bridge No. 66B. (85/8)
217 Leigh-on-Sea and Benfleet	Up	Sea wall work. (85/34)
218 Leigh-on-Sea	Down	09 00 to 16 00. Demolition work. Mechanical equipment in use. (85/60)
219 Westcliff-on-Sea	Down	09 00 to 16 00. Demolition work. Mechanical equipment in use. (85/60)
SATURDAY 6 DECEMBER		
220 Upminster and Laindon (London End)	Down and Up BLOCKED	01 15 to 04 25. Overhead line work. Crane and mechanical equipment in use. <u>Trains diverted via Grays.</u>
221 Upminster and Pitsea Jn	All BLOCKED to electric trains	01 15 to 04 25. In connection with engineering work. <u>Isolation of electrical sections 517, 518, 519, 520, 521E, 522A. Electric trains diverted via Grays.</u>
222 Laindon (London End) and Pitsea Jn	All BLOCKED	01 15 to 04 25. Painting Laindon, Basildon and Pitsea Stations. <u>Trains diverted via Grays.</u>

SECTION B - TEMPORARY ENGINEERING WORKS - continued

At or between	Lines affected	Remarks
---------------	----------------	---------

FENCHURCH STREET TO SHOEBURYNESS - continued

SATURDAY/SUNDAY 6/7 AND SUNDAY 7 DECEMBER

223	Leigh-on-Sea Southend Central	Up BLOCKED Down BLOCKED	23 30 Sat to 10 00)Track maintenance,)and repairs to 01 45 to 10 00 Sun)platform awnings)and painting)Chalkwell and)Westcliff-on-Sea)stations.)23 30 Sat to 10 00)Isolation of) <u>electrical sections</u>) <u>523A, 525BC.</u>)01 45 to 10 00 Sun.)Isolation of) <u>electrical sections</u>) <u>524C, 528AB.</u>
-----	-------------------------------------	----------------------------------	--

SUNDAY 7 DECEMBER

224	Gas Factory Jn and East Ham (London End)	Down and Up BLOCKED	01 00 to 06 15. Track maintenance, track renewal and loading rails. Crane and mechanical equipment in use. <u>Isolation of electrical sections,</u> <u>505, 506, 507 and 508.</u>
225	Upminster and Laindon	Down BLOCKED Up BLOCKED	01 20 to 05 15)Overhead line work.)01 20 to 05 15. 01 20 to 18 00)Isolation of <u>electrical</u>) <u>sections. 518.</u>)01 20 to 18 00.)Isolation of) <u>electrical sections</u>) <u>517. 05 15 to 18 00</u>) <u>Single line working</u>) <u>over Up line.</u>

MONDAY 8 TO FRIDAY 12 DECEMBER

226	Fenchurch St. and Christian Street Jn	Down and Up Slow BLOCKED)10 25 to 15 45 daily. Construction)work. Crane and mechanical equipment)in use. <u>Isolation of electrical</u>) <u>sections 503B, 504AB. Trains to</u>
	Fenchurch St. Station	Platforms 1 and 2 BLOCKED) <u>travel over Fast lines and to be</u>) <u>replatformed as necessary.</u>

SECTION B - TEMPORARY ENGINEERING WORKS - continued

At or between	Lines affected	Remarks
<u>FENCHURCH STREET TO SHOEBURYNESS - continued</u>		
MONDAY 8 TO SATURDAY 13 DECEMBER		
227 East Ham (London End) and Barking Station (London End)	Down and Up Main BLOCKED	21 15 Mon to Fri to 05 15 Tue to Sat. Bridgework (No. 66B). Crane and mechanical equipment in use. <u>Isolation of electrical sections</u> <u>510A, 511E.</u>
228 Shoeburyness and Leigh-on-Sea Southend Central	Up Main BLOCKED Platform 4 BLOCKED)23 20 Mon to Fri to 04 10 Tue to Sat.)Painting stations and repairs to)platform awnings (Southend Central,)Westcliff-on-Sea and Chalkwell)stations). <u>Isolation of electrical</u> <u>sections 523 and 525.</u>
TUESDAY 9 TO WEDNESDAY 10 DECEMBER		
229 Laindon (London End) and Pitsea Jn	All BLOCKED	01 15 to 04 25 daily. Painting Laindon, Basildon and Pitsea stations and track maintenance. Mechanical equipment in use. <u>Trains diverted via Grays.</u>
TUESDAY 9 TO FRIDAY 12 DECEMBER		
230 Upminster and Laindon (London End)	Down and Up BLOCKED	01 15 to 04 25 daily. Overhead line work. Mechanical equipment in use. <u>Trains diverted via Grays.</u>
231 Upminster and Pitsea Jn	All BLOCKED to electric trains	01 15 to 04 25 daily. In connection with engineering work. <u>Isolation of</u> <u>electrical sections 517, 518, 519,</u> <u>520, 521E, 522A.</u> Electric trains <u>diverted via Grays.</u>
THURSDAY 11 TO FRIDAY 12 DECEMBER		
232 Laindon (London End) and Pitsea Jn	All BLOCKED	01 15 to 04 25 daily. Painting Laindon, Basildon and Pitsea Stations. <u>Trains diverted via Grays.</u>
233 Shoeburyness	All BLOCKED	00 30 to 04 30 daily. Track maintenance. Mechanical equipment in use. <u>Possession to be given up for</u> <u>passage of trains.</u>

SECTION B - TEMPORARY ENGINEERING WORKS - continued

<u>At or between</u>	<u>Lines</u>	<u>Remarks</u>
	<u>affected</u>	

FENCHURCH STREET TO SHOEBURYNESSE - continued

FRIDAY/SATURDAY 12/13 DECEMBER

234	Fenchurch St. and Gas Factory Jn	All BLOCKED	21 15 to 05 30. Loading materials. <u>22 15 Fri to 04 30. Isolation of electrical sections 501, 502, 503 and 504.</u>
-----	--	----------------	--

GAS FACTORY JN TO BOW JN

SATURDAY 6 TO MONDAY 8 DECEMBER

235	Gas Factory Jn and Bow Jn	Single BLOCKED	00 15 Sat to 00 01 Mon. In connection with engineering work. <u>Isolation of electrical sections 309A. 01 00 to 06 15 Sun. Isolation of electrical sections 506A.</u>
-----	------------------------------	-------------------	--

UPPER HOLLOWAY TO BARKING, TILBURY LINE JN WEST

UNTIL FURTHER NOTICE

236	Upper Holloway and Crouch Hill Station	Down and Up	Earthwork. 3m 4lchs. and 3m 43chs. Mechanical equipment in use. (85/64)
237	Wanstead Park Station	Up	08 00 to 16 00. Platform work. <u>(See Section 'D').</u> (85/50)
238	Woodgrange Park and Barking Station Jn	Down and Up <u>Between Trains</u>	07 30 to 18 00. Bridgework (No. 6). 12m. 26chs. Crane and mechanical equipment in use. (85/62)
239	Woodgrange Park and Barking Tilbury Line Jn West	Down and Up	Erecting scaffolding in connection with bridge No. 14A. (85/8)

SECTION B - TEMPORARY ENGINEERING WORKS - continued

At or between	Lines affected	Remarks
---------------	----------------	---------

UPPER HOLLOWAY TO BARKING, TILBURY LINE JN WEST - continued

SUNDAY 7 DECEMBER

240	South Tottenham East Jn and Woodgrange Park Jn	Down and Up BLOCKED	00 01 to 23 59. Overhead line work, track maintenance and track renewal. Crane and mechanical equipment in use. <u>4M52 21 00 Tilbury RCT to Bescot diverted via Stratford.</u>
241	Forest Gate Jn and Woodgrange Park Station	Down and Up BLOCKED	00 50 to 17 00. Overhead line work. Mechanical equipment in use. <u>Possession to be given up for passage of Engineers' trains.</u>

SUNDAY 7 TO MONDAY 8 DECEMBER

242	Forest Gate Jn and Barking Tilbury Line Jn West	Down and Up BLOCKED to electric trains	00 50 Sun to 04 00 Mon. In connection with engineering work. <u>Isolation of electrical sections 512AB, 513EF.</u>
243	Woodgrange Park Station (Country End) and Barking Tilbury Line Jn West	Down and Up BLOCKED	00 50 to 04 00 Mon. Bridgework. (No. 14). Crane and mechanical equipment in use. <u>Possession to be given up for passage of Diesel trains.</u>

BARKING, TILBURY LINE JN EAST TO TILBURY RIVERSIDE

UNTIL FURTHER NOTICE

244	Dagenham Dock Station	Down and Up	08 00 to 17 00. Construction work. Mechanical equipment in use. (85/14)
245	Rainham Station	Down and Up	08 00 to 17 00. Construction work. Mechanical equipment in use. (85/14)
246	Purfleet Station	Down and Up	09 00 to 16 00. Platform work. Mechanical equipment in use. (85/61)

SECTION B - TEMPORARY ENGINEERING WORKS - continued

At or between	Lines affected	Remarks
---------------	----------------	---------

BARKING, TILBURY LINE JN EAST TO TILBURY RIVERSIDE - continued

SUNDAY 7 DECEMBER

247	Barking Tilbury Line Jn East and West Thurrock Jn	Down and Up Main BLOCKED	00 45 to 07 00. Track maintenance. Mechanical equipment in use.
-----	---	-----------------------------	---

TILBURY RIVERSIDE TO PITSEA

SATURDAY/SUNDAY 6/7 DECEMBER

248	Stanford-le-Hope and Pitsea	Down and Up BLOCKED	23 55 to 21 40. Track maintenance, track renewal and overhead line work. Mechanical equipment in use. <u>Isolation of electrical sections 536CD, 537AB.</u>
-----	-----------------------------	------------------------	---

SUNDAY 7 DECEMBER

249	Tilbury East Jn and Stanford-le-Hope	Down and Up BLOCKED	01 30 to 06 30. Track maintenance 24m. 18chs and 24m. 19chs.
-----	--------------------------------------	------------------------	--

MONDAY 8 TO FRIDAY 12 DECEMBER

250	Stanford-le-Hope and Pitsea	Down BLOCKED	23 55 Mon to Thu to 05 00 Tue to Fri. Track maintenance. <u>Single line working over Up line.</u>
-----	-----------------------------	-----------------	---

SECTION CSIGNALLING AND PERMANENT WAY ALTERATIONS

* * Items marked thus will not appear in future issues and a note must be
 * taken of them by all concerned.

DETAILS OF WORK REFERRED TO IN SECTION BSUNDAY 7 DECEMBER - DISS

The Up Main 2-aspect Distant signal No. C0436R (on the Up approach to Diss Station) will be altered so as to be capable of displaying Yellow, double Yellow or a Green aspect.

(40)

MONDAY 9 DECEMBER - BETWEEN ST. GERMANS LC AND KING'S LYNN

The Permanent Speed Restrictions applicable to both Down and Up trains on the SINGLE line between 95m.p. and King's Lynn station will be REVISED. The new Permanent Speed Restrictions are shown in Section 'D'.

(40)

DETAILS OF WORK ALREADY CARRIED OUTMILE END YARD

The 3-aspect colour light signal No. B113 which reads from Mile End Yard Up Reception to the Down Electric line has been replaced by an elevated position light signal (8ft above rail level), 19ft on the approach side of the outlet trap points.

(39)

NEW HALL

The Up Loop has been taken out of use Until Further Notice.

(UFN)

HATFIELD PEVEREL

The facing and trailing crossovers are out of use until further notice.

(UFN)

SWAINSTHORPE AUTOMATIC HALF-BARRIERS AT 109M. 54CHS.

When the road works are resumed, the crossing will be closed to road traffic and the barriers secured in the lowered position until such time as the work is completed.

(UFN)

SECTION C - SIGNALLING AND PERMANENT WAY ALTERATIONS - continuedDETAILS OF WORK ALREADY CARRIED OUT - continuedTROWSE AREA

New colour light signalling has been commissioned as shown in Supplementary Signalling Notice No. 146.

All concerned should be in possession of a copy of this notice. (39)

TROWSE LOWER JUNCTION

The trailing connection Up Siding/Up Main nearest to the signalbox and on the Norwich side has been secured out of use pending removal.

The associated yellow faced disc shunting signal has been abolished. (38)

BETWEEN PARKESTON GOODS JN AND WRABNESS

The $\frac{30}{50}$ m.p.h. Temporary Speed Restriction on the UP line between 66m. 70chs. and 66m. 10chs. has become a PERMANENT SPEED RESTRICTION.
(See Section 'D') (39)

STEPNEY EAST

The signal post telephone associated with Up Main signal F219 (London side of Stepney East Station) has been temporarily repositioned 30 yards on the approach side of the signal pending provision of a loud speaking telephone at the signal.

(New Item) (40)

SECTION D

GENERAL INSTRUCTIONS AND NOTICES

A thick vertical line denotes new or amended items.

** Items marked thus will not appear in future issues and a note must be taken of them by all concerned.
*

EASTERN REGION SECTIONAL APPENDIX (SOUTHERN AREA)

TABLE A : DETAILS OF RUNNING LINES

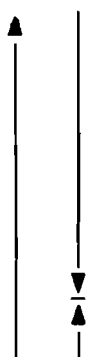
Running Lines and Signalling System	Location	M. Ch.	Permanent Speed Restrictions		Remarks
			Down m.p.h.	Up m.p.h.	
<u>LIVERPOOL STREET TO NORWICH</u>					
Page 61 (Page	, SD PON)				
Delete all details between Swainsthorpe LC and Norwich and substitute:-					
	Swainsthorpe LC(AHB-X)	109 54	<u>X50</u>	<u>X50</u>	<u>Approaching level crossing in wrong direction.</u>
				<u>90</u>	<u>111m. 15chs. and 110m. 55chs.</u>
				<u>80</u>	<u>111m. 15chs. and 112m. 62chs.</u>
				<u>40</u>	<u>112m. 62chs. and 113m. 46chs.</u>
		113 31	<u>35</u>	<u>35</u>	<u>Down Main 113m. 46chs. and 123m.p.</u>

SE-49

SECTION D - GENERAL INSTRUCTIONS AND NOTICES - continued

EASTERN REGION SECTIONAL APPENDIX (SOUTHERN AREA) - continued

Running Lines and Signalling System	Location	M. Ch.	Permanent Speed Restrictions		Remarks	
			Down m.p.h.	Up m.p.h.		
<u>LIVERPOOL STREET TO NORWICH - continued</u>						
Page 61						
Delete all details between Swainsthorpe and Norwich and substitute: -						
	Trowse Jn (See page 103)	113 68 123 00		25	Up Main 123m.p. and 113m. 46chs.	D & UPL 35†. † The Up Main line and D & UPL are worked in the Down direction for trains from the Ely line only.
			20	20	Main lines 123m.p. and 123m. 33chs.	
			15		All lines 123m. 33chs. and 124m. 09chs.	
	Trowse Swing Bridge	123 37				
	Thorpe Jn (See page 78)	123 60		15	To Lowestoft line	

SE-50

SECTION D - GENERAL INSTRUCTIONS AND NOTICES - continued

EASTERN REGION SECTIONAL APPENDIX (SOUTHERN AREA) - continued

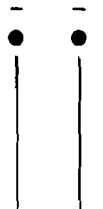
Running Lines and Signalling System	Location	M. Ch.	Permanent Speed Restrictions		Remarks
			Down m.p.h.	Up m.p.h. At or Between	
<u>LIVERPOOL STREET TO NORWICH - continued</u>					
<u>Page 61 - continued</u>					
Delete all details between Swainsthorpe and Norwich and substitute: -					
	Norwich (No)	123 66			Norwich (No) signal box area between Swainsthorpe (exclusive) and Norwich.
	Norwich	124 09	15	<u>All lines 124m. 09chs. and 123m. 33chs.</u>	(2.SD)
<u>BETHNAL GREEN JN TO KING'S LYNN</u>					
<u>Page 84</u>					
Between Bishops Stortford and Stansted					
Delete :- OHNS, mileage and square symbols from "Running Lines and Signalling System" column.					

SE-51

SECTION D - GENERAL INSTRUCTIONS AND NOTICES - continued

EASTERN REGION SECTIONAL APPENDIX (SOUTHERN AREA) - continued

Running Lines and Signalling System	Location	M. Ch.	Permanent Speed Restrictions		Remarks
			Down m.p.h.	Up m.p.h.	
<u>BETHNAL GREEN JN TO KING'S LYNN - continued</u>					
<u>Pages 84 and 85</u>					
<u>Delete :- all details between Stansted and Fullers End Footpath LC and substitute :-</u>					
	Stansted	33 28			DGL 67
	OHNS †	33 61			† OHNS also provided on Stansted DGL at 33m. 61chs.
	Fullers End Footpath LC (R/G)	34 67			<u>(w.e.f. 00 01 hours, Monday 8 December) (2.SD)</u>

SECTION D - GENERAL INSTRUCTIONS AND NOTICES - continued

EASTERN REGION SECTIONAL APPENDIX (SOUTHERN AREA) - continued

Running Lines and Signalling System	Location	M. Ch.	Permanent Speed Restrictions		Remarks
			Down m.p.h.	Up m.p.h.	
<u>BETHNAL GREEN JN TO KING'S LYNN - continued</u>					
<u>Page 88 (Page</u>	, SD PON)				
<u>Delete :- all details between St. Germans LC and King's Lynn and substitute:-</u>					
	St. Germans LC (AOCR)	92 53			
	King's Lynn Harbour Jn (See page 100)	95 27	<u>60</u>	<u>10</u>	<u>95m.p. and 96m. 02chs.</u> <u>To South Lynn line.</u>
			<u>30</u>	<u>60</u>	<u>96m. 02chs. and 95m.p.</u> <u>96m. 02chs. and 96m. 42chs.</u> <u>except 15 m.p.h. approaching</u> <u>Extons Road LC</u>
	Extons Road LC (AOCL)	96 24	<u>15</u>	<u>15</u>	<u>96m. 23chs. and 96m. 02chs.</u> <u>Approaching level crossing</u>
	King's Lynn Jn (KL) LC (See page 101)	96 50	<u>20</u>		<u>96m. 42chs. and 96m. 75chs.</u>
King's Lynn	96 75		<u>20</u>	<u>96m. 75chs. and 96m. 23chs.</u> <u>except 15m.p.h. approaching</u> <u>Extons Road LC</u>	
(w.e.f. 00 01 hours, Monday 8 December) (2.SD)					

SECTION D - GENERAL INSTRUCTIONS AND NOTICES - continued

EASTERN REGION SECTIONAL APPENDIX (SOUTHERN AREA) - continued

Running Lines and Signalling System	Location	M. Ch.	Permanent Speed Restrictions		Remarks
			Down m.p.h.	Up m.p.h.	
<p><u>ELY NORTH JN TO TROWSE LOWER JN</u></p> <p><u>Page 101</u></p> <p><u>Amend</u> line heading to read :-</p> <p><u>ELY NORTH JN TO TROWSE JN</u></p> <p><u>Page 101</u> (Page , SD PON)</p> <p><u>Amend</u> last two Maximum Permissible Speed entries to read:-</p> <p>HEATH LC (104m. 07chs.) AND TROWSE JN TROWSE JN AND 102m. 75chs.</p> <p><u>Page 102</u></p> <p><u>Amend</u> line heading to read :-</p> <p><u>ELY NORTH JN TO TROWSE JN</u></p>			<u>70</u>	<u>70</u>	MAXIMUM PERMISSIBLE SPEED

SECTION D - GENERAL INSTRUCTIONS AND NOTICES - continued

EASTERN REGION SECTIONAL APPENDIX (SOUTHERN AREA) - continued

Running Lines and Signalling System	Location	M. Ch.	Permanent Speed Restrictions		At or Between	Remarks
			Down m.p.h.	Up m.p.h.		
<p>ELY NORTH JN TO TROWSE LOWER JN - continued</p> <p>Page 103</p> <p>Delete all details between Hethersett and Trowse Lower Jn and substitute :-</p>						
	Hethersett (HT) LC	117 73				URS 48
	Intwood LC (AHB-X)	119 47	X30	X30	<u>Approaching level crossing in wrong direction.</u>	
	Keswick LC (AHB-X)	120 00	X30	X30	<u>Approaching level crossing in wrong direction.</u>	Telephone to Hethersett signal box at 120m. 02chs. (Hethersett Up Distant signal).
	Eaton LC (R/G-X)	120 29	X30	X30	<u>Approaching level crossing in wrong direction.</u>	Telephone to Norwich signal box at 120m. 65chs. (Signal No. 889R). (Controlled by Norwich (No) signal box.
	Trowse Lower Jn (See page 61)	123 00				(2.SD)

SE-55

SECTION D - GENERAL INSTRUCTIONS AND NOTICES - continued

EASTERN REGION SECTIONAL APPENDIX (SOUTHERN AREA) - continued

Running Lines and Signalling System	Location	M. Ch.	Permanent Speed Restrictions		Remarks
			Down m.p.h.	Up At or Between	
<p><u>FENCHURCH STREET TO SHOEBURYNES</u></p> <p><u>Page 105</u></p> <p>Between West Horndon and Laindon</p> <p>Amend "Running Lines and Signalling System" column and Add new Overhead Line Neutral Sections :-</p> <p>↑ ↓</p>	OHNS	20 76			
					(w.e.f. Sunday 7 December) (2.SD)

SE-56

SECTION D - GENERAL INSTRUCTIONS AND NOTICES - continuedEASTERN REGION SECTIONAL APPENDIX (SOUTHERN AREA) - continuedTABLE B - SPECIAL WORKING ARRANGEMENTS

Between	Lines	Authorities	Restrictions
<u>Page 165</u>			
	<u>LIVERPOOL STREET TO NORWICH</u>		
<u>Delete</u>	Trowse Upper Jn/Trowse Lower Jn entry		
<u>Delete</u>	Trowse Lower Jn/Norwich Thorpe Jn entry.		
<u>Delete</u>	Trowse Yard/Trowse Lower Jn entry.		(2.SD)

LOCAL INSTRUCTIONSPage 334FENCHURCH STREET TO SHOE BURYNNESSAdd:- BETWEEN STEPNEY EAST AND CHRISTIAN STREET JN

The Driver of any train detained at signal UF2C or F.225 must wait 5 minutes before contacting the Signaller from the Signal Post telephone.

(UFN)

MISCELLANEOUS NOTICES

ENGINEERING WORK BETWEEN BETHNAL GREEN AND BOW JN
DIVERSION OF PARCELS/MAIL AND NEWSPAPER TRAINS VIA TOTTENHAM HALE
SATURDAY 6 AND SUNDAY 7 DECEMBER

The following diverted trains are authorised to run between Liverpool Street and Tottenham Hale, where the trains will reverse, with a locomotive attached in rear:-

1H70 22 51 (Sat) Liverpool Street to Peterborough (via Ipswich)
 1Y02 02 20 (Sun) Liverpool Street to Stowmarket
 1W46 03 15 (Sun) Liverpool Street to Shenfield
 1K06 03 45 (Sun) Liverpool Street to Southend Victoria

SECTION D - GENERAL INSTRUCTIONS AND NOTICES - continued

MISCELLANEOUS NOTICES - continued

ENGINEERING WORK BETWEEN BETHNAL GREEN AND BOW JN
DIVERSION OF PARCELS/MAIL AND NEWSPAPER TRAINS VIA TOTTENHAM HALE
SATURDAY 6 AND SUNDAY 7 DECEMBER - continued

The following conditions must be observed:-

1. The provisions of the Rule Book, Section H, Clause 3.20 and the preamble to Sectional Appendix, Table J must be observed.
2. Except in emergency, the Driver of the rear locomotive must not apply power.
3. If the rear locomotive is S.S.S. fitted, the reverser must be placed in the direction of travel.

(37)

1. RULE BOOK AMENDMENT PAGES - ISSUE NO. 13 - B.R. 87109/39
2. GENERAL APPENDIX AMENDMENT PAGES - ISSUE NO. 8 - B.R. 29944/35
3. SIGNALMEN'S GENERAL INSTRUCTIONS - ISSUE NO. 4 - B.R. 30062/12

The above mentioned publications are in the course of printing and distribution, and will operate from Saturday 7 February 1987. The publication must be made available to staff concerned immediately on receipt.

Any member of the staff who is in possession of the current issue of the Rule Book, General Appendix or Signalmen's General Instructions who does not receive a copy of the appropriate amendment pages/supplement by 12 January must promptly advise his supervisor.

(46)

BETWEEN STOWMARKET AND TIVETSHALL (HALL GREEN)

Until further notice, in connection with testing of the overhead line system between Stowmarket and Tivetshall (Hall Green), electric trains, other than test trains, are not permitted to run north of Stowmarket.

(UFN)

BETWEEN BISHOPS STORTFORD AND CAMBRIDGE (NORTH)

Until further notice, in connection with testing of the overhead line system between Bishops Stortford (Country End) and Cambridge (North), electric trains, other than test trains, are not permitted to run North of Bishops Stortford. From 00 01 Monday 8 December.

(UFN)

SECTION D - GENERAL INSTRUCTIONS AND NOTICES - continuedMISCELLANEOUS NOTICES - continuedFENCHURCH STREET TO SHOEBURYNESS LINE - DUNTON AREA
INSTALLATION OF NEUTRAL SECTION

Between 01 15 and 18 00 hours Sunday 7 December, a NEUTRAL SECTION will be installed at overhead line structure A20/34B on the Up Main between West Horndon and Laindon stations (20 miles 76 chains).

(2.SD)

FENCHURCH STREET TO SHOEBURYNESS LINE DUNTON AREA
INSTALLATION OF NEUTRAL SECTION

A NEUTRAL SECTION has been installed at overhead line structure A20/34A on the Down Main between West Horndon and Laindon Stations (20m. 76chs.).

(2.SD)

* *

INSTRUCTIONS FOR D.C. ELECTRIFIED LINES* BETWEEN EUSTON-WATFORD JN, CROXLEY GREEN-NORTH WOOLWICH B.R.29636

Supplement No. 2 to the above publication is in the course of being distributed.

Any member of staff who is in possession of the current issue of B.R.29636 who has not received a copy of the Supplement must promptly advise his Supervisor.

(37)

WORKING OF CLASS 313 AND CLASS 416 ELECTRIC MULTIPLE UNIT
TRAINS BETWEEN DALSTON WESTERN JN AND STRATFORD MARKETClass 313 Electric Multiple Units

These units must only work between Navarino Road Jn and Stratford Market stabling sidings when either the Graham Road Curve route to Liverpool Street is not available, or when the pantographs have failed to rise. When operating between Dalston Kingsland and Stratford Market stabling sidings and return in the D.C. mode, Drivers must not advance the controller beyond Notch 2.

THESE UNITS MUST NOT RUN BEYOND STRATFORD MARKET TOWARDS NORTH WOOLWICH.

Class 416 Electric Multiple Units

Not more than two Class 416 units may be coupled together.

When two Class 416 units are running in multiple between Dalston Western Jn and Stratford Market, including the stabling sidings or return, Drivers must not advance the controller beyond Notch 2.

(UFN)

SECTION D - GENERAL INSTRUCTIONS AND NOTICES - continued

MISCELLANEOUS NOTICES - continued

BETWEEN STEPNEY EAST AND FENCHURCH STREET

Until further notice, staff of the Docklands Light Railway will be laying in track adjacent to the Up Main/Slow line between Stepney East Station (1m. 58chs.) and Fenchurch Street. Restricted clearances exist and Drivers must keep a sharp look out and be prepared to sound the warning horn as necessary.
(UFN)

BETHNAL GREEN STATION

Until Further Notice, whilst demolition work is taking place, Drivers of 4-Car EMU trains must stop their trains at the temporary stop boards provided.
(UFN)

CAMBRIDGE HEATH STATION

Whilst platform repairs are taking place, Drivers of trains must stop their trains at the temporary stop boards provided.
(UFN)

LONDON FIELDS STATION

The station has reopened but platform repairs are taking place. Whilst this work is being carried out, Drivers must stop their trains at the temporary stop boards provided.
(UFN)

SAWBRIDGEWORTH STATION

The stop board on the Up platform has been temporarily moved 9 yards towards the Country side of its former position.
(UFN)

WANSTEAD PARK STATION

Whilst platform repairs are taking place, Drivers of Up trains must stop their trains at the temporary stop boards provided.
(UFN)

SECTION D - GENERAL INSTRUCTIONS AND NOTICES - continuedMISCELLANEOUS NOTICES - continuedREPAIRS IN MOTIVE POWER DEPOTS, CARRIAGE SHEDS, WAGON REPAIR SHEDS AND WAREHOUSES

In connection with work being carried out at the undermentioned places, scaffolding or projections may be provided or unusual excavations may be made in the ground:-

Location	Nature of Work	Duration	Commencing date
Stratford T.M.D. All lines.	Repairs to Motive Power Depot. Cranes and mechanical equipment in use.	Continuously. Until Further Notice.	-
Ilford EMU Depot, Nos. 19 and 20 Roads.	Drainage.	08 00 to 17 00 daily. Until Further Notice.	-
Ilford EMU Depot, 'B' Shop Roads Nos. 3, 4 and 5.	Construction work. <u>Isolation of electrical sections C3, 4 and 5.</u>	Continuously. Until further notice.	-
Ilford EMU Depot, Nos. 6, 7, 8, 9 and 10 Sidings (Country End) BLOCKED	Track renewal.	Continuously. Until further notice.	-
Norwich Crown Point T & R.S. M.D., All lines BLOCKED	Construction work (overhead line) and track maintenance. Mechanical equipment in use. <u>Possession to be given up for passage of trains.</u>	08 00 to 17 00 daily. Until further notice.	-
East Ham EMU Depot, All lines.	Shed reconstruction.	Continuously. Until Further Notice.	-
East Ham EMU Depot, Washer Road BLOCKED	Repairs to washer plant. <u>Isolation of electrical sections 509A.</u>	Continuously. Until Further Notice.	-

SECTION D - GENERAL INSTRUCTIONS AND NOTICES - continuedMISCELLANEOUS NOTICES - continuedREPAIRS IN MOTIVE POWER DEPOTS, CARRIAGE SHEDS, WAGON REPAIR SHEDS AND WAREHOUSES - continued

In connection with work being carried out at the undermentioned places, scaffolding or projections may be provided or unusual excavations may be made in the ground:-

Location	Nature of Work	Duration	Commencing date
East Ham EMU Depot, Nos. 10 and 11 Maintenance Shed Roads BLOCKED	Construction work. <u>Isolation of electrical sections EH10, EH11.</u>	Continuously. Until Further Notice.	-
East Ham EMU Depot, Nos. 17, 18, 19 and 20 Sidings BLOCKED to electric trains	In connection with engineering work between East Ham and Barking. Crane and mechanical equipment in use. <u>Isolation of electrical sections 509J.</u>	21 15 Mon to Fri to 05 15 Tue to Sat.	<u>From Monday 8 until Saturday 13 December.</u>
Shoeburyness CSD, No. 16 Road BLOCKED	Cleaning Admin. Block windows. <u>Isolation of electrical sections 529A.</u>	10 00 to 12 00. <u>Thursday 11 December.</u>	-

MP.32/SE
YORK
27 NOVEMBER, 1986

C. McKEEVER
Regional Operations Manager